

R-3896-1

TECHNICAL MANUAL**ENGINE DATA****F-1 ROCKET ENGINE**

(ROCKETDYNE)

CHANGE
NOTICE**LATEST CHANGED PAGES SUPERSEDE
THE SAME PAGES OF PREVIOUS DATE**Insert changed pages into basic
publication. Destroy superseded pages.

PUBLISHED UNDER AUTHORITY OF THE NATIONAL AERONAUTICS AND SPACE ADMINISTRATION

31 MARCH 1967

CHANGE NO. 12 - 12 MAY 1972

LIST OF EFFECTIVE PAGES

NOTE: The portion of the tax affected by the changes is indicated by a vertical line in the outer margins of the page.

TOTAL NUMBER OF PAGES IN THIS PUBLICATION IS 228 CONSISTING OF THE FOLLOWING:

| Page No. | Change No. | Issue | Page No. | Change No. | Issue | Page No. | Change No. | Issue |
|-------------------|------------|-----------|-------------------|------------|-----------|----------|------------|-------|
| Title..... | 12 | 12 May 72 | 2-4G thru 2-8H | | | | | |
| A..... | 12 | 12 May 72 | Deleted..... | 9 | 4 Nov 70 | | | |
| 1 thru 11..... | 10 | 16 Jul 71 | 2-8J thru 2-8K... | 5 | 11 Mar 68 | | | |
| iii..... | 9 | 4 Nov 70 | 2-9I..... | 10 | 16 Jul 71 | | | |
| iv..... | 10 | 16 Jul 71 | 2-8M..... | 7 | 18 Aug 69 | | | |
| v..... | 12 | 12 May 72 | 2-9 thru 2-10.... | 9 | 4 Nov 70 | | | |
| vi thru vii..... | 10 | 16 Jul 71 | 2-11..... | 10 | 16 Jul 71 | | | |
| viii..... | 12 | 12 May 72 | 2-12 thru 2-13... | 12 | 12 May 72 | | | |
| ix..... | 9 | 4 Nov 70 | 2-14..... | 10 | 16 Jul 71 | | | |
| x..... | 10 | 16 Jul 71 | 2-15 thru | | | | | |
| xi..... | 11 | 10 Nov 71 | 2-17/2-18..... | 9 | 4 Nov 70 | | | |
| xii..... | 7 | 18 Aug 69 | 2-19/2-20 Deleted | 9 | 4 Nov 70 | | | |
| xiii..... | 12 | 12 May 72 | 2-21 thru 2-22 | | | | | |
| xiv..... | 11 | 10 Nov 71 | Deleted..... | 2 | 10 Aug 67 | | | |
| xv..... | 7 | 18 Aug 69 | 2-23..... | 2 | 10 Aug 67 | | | |
| xvi..... | 12 | 12 May 72 | 2-24..... | 6 | 14 Aug 68 | | | |
| xvii..... | 7 | 18 Aug 69 | 2-25 thru 2-28... | 9 | 4 Nov 70 | | | |
| xviii..... | 9 | 4 Nov 70 | 2-29..... | 6 | 14 Aug 68 | | | |
| xix..... | 10 | 16 Jul 71 | 2-30 thru 2-33... | 9 | 4 Nov 70 | | | |
| xx..... | 12 | 12 May 72 | 2-34..... | 6 | 14 Aug 68 | | | |
| 1-1..... | 10 | 16 Jul 71 | 2-35..... | 9 | 4 Nov 70 | | | |
| 1-2 thru 1-4.... | 9 | 4 Nov 70 | 2-36..... | 6 | 14 Aug 68 | | | |
| 1-5..... | 7 | 18 Aug 69 | 2-37 thru 2-38... | 4 | 13 Feb 68 | | | |
| 1-6 thru 1-6B... | 10 | 16 Jul 71 | 2-39 thru 2-46 | | | | | |
| 1-7..... | 7 | 18 Aug 69 | Deleted..... | 2 | 10 Aug 67 | | | |
| 1-8..... | 10 | 16 Jul 71 | 2-47..... | 9 | 4 Nov 70 | | | |
| 1-9 thru 1-9B... | 8 | 10 Feb 70 | 2-48..... | 10 | 16 Jul 71 | | | |
| 1-10 thru 1-11.. | 8 | 10 Feb 70 | 2-49 thru 2-50... | 9 | 4 Nov 70 | | | |
| 1-12 thru 1-14.. | 7 | 18 Aug 69 | 2-51..... | 12 | 12 May 72 | | | |
| 1-15..... | 8 | 10 Feb 70 | 2-52..... | 7 | 18 Aug 69 | | | |
| 1-16..... | 10 | 16 Jul 71 | 2-53..... | 12 | 12 May 72 | | | |
| 1-16A thru 1-16B. | 8 | 10 Feb 70 | 2-54..... | 9 | 4 Nov 70 | | | |
| 1-17 thru 1-18.. | 8 | 10 Feb 70 | 2-55 thru 2-56... | 7 | 14 Aug 68 | | | |
| 1-19..... | 10 | 16 Jul 71 | 2-57 thru 2-72... | 9 | 4 Nov 70 | | | |
| 1-20..... | 8 | 10 Feb 70 | 2-73 2-74..... | 2 | 10 Aug 67 | | | |
| 1-21..... | 10 | 16 Jul 71 | 3-1..... | 10 | 16 Jul 71 | | | |
| 1-22 thru 1-24.. | 7 | 18 Aug 69 | 3-2..... | 6 | 14 Aug 68 | | | |
| 1-25..... | 10 | 16 Jul 71 | 3-3..... | 4 | 13 Feb 68 | | | |
| 1-26 thru 1-29.. | 8 | 10 Feb 70 | 3-4..... | 9 | 4 Nov 70 | | | |
| 1-30 thru 1-33... | 9 | 4 Nov 70 | 3-5 thru | | | | | |
| 1-34..... | 7 | 18 Aug 69 | 3-6A/3-6B..... | 10 | 16 Jul 71 | | | |
| 1-35..... | 10 | 16 Jul 71 | 3-7 thru 3-10... | 10 | 16 Jul 71 | | | |
| 1-36..... | 7 | 18 Aug 69 | 3-11 thru 3-16 | | | | | |
| 1-37..... | 10 | 16 Jul 71 | Deleted..... | 9 | 4 Nov 70 | | | |
| 1-38 thru 1-42.. | 7 | 18 Aug 69 | 3-17/3-18..... | 7 | 18 Aug 69 | | | |
| 1-43..... | 9 | 4 Nov 70 | 3-19 thru 3-20... | 7 | 18 Aug 69 | | | |
| 1-44..... | 7 | 18 Aug 69 | 3-21..... | 9 | 4 Nov 70 | | | |
| 1-45..... | 9 | 4 Nov 70 | 3-22..... | 10 | 16 Jul 71 | | | |
| 1-46..... | 7 | 18 Aug 69 | 3-23 thru 3-24... | 0 | Original | | | |
| 1-47..... | 9 | 4 Nov 70 | 3-25 thru | | | | | |
| 1-48..... | 7 | 18 Aug 69 | 3-27/3-28..... | 9 | 4 Nov 70 | | | |
| 1-48A/1-48B... | 9 | 4 Nov 70 | 3-29 thru 3-38 | | | | | |
| 1-49 thru 1-50... | 7 | 18 Aug 69 | Deleted..... | 9 | 4 Nov 70 | | | |
| 1-51..... | 10 | 16 Jul 71 | 3-30 thru 3-41... | 12 | 12 May 72 | | | |
| 1-52 thru 1-62.. | 7 | 18 Aug 69 | 3-42..... | 9 | 4 Nov 70 | | | |
| 1-63 thru 1-70... | 9 | 4 Nov 70 | 3-43 thru | | | | | |
| 1-80..... | 10 | 16 Jul 71 | 3-44..... | 12 | 12 May 72 | | | |
| 1-81 thru 1-84... | 9 | 4 Nov 70 | 3-45..... | 12 | 12 May 72 | | | |
| 2-1/2-2..... | 10 | 16 Jul 71 | 3-46..... | 9 | 4 Nov 70 | | | |
| 2-3..... | 9 | 4 Nov 70 | 3-47 thru 3-54 | | | | | |
| 2-4 thru 2-5.... | 4 | 13 Feb 68 | Deleted..... | 9 | 4 Nov 70 | | | |
| 2-6..... | 9 | 4 Nov 70 | 3-55 thru | | | | | |
| 2-7 thru 2-8.... | 0 | Original | 3-57/3-58..... | 6 | 14 Aug 68 | | | |
| 2-8A thru 2-8B... | 5 | 11 Mar 68 | A-1/A-2..... | 10 | 16 Jul 71 | | | |
| 2-8C thru | | | | | | | | |
| 2-8E/2-8F..... | 9 | 4 Nov 70 | | | | | | |

Upon receipt of the second and subsequent changes to this technical manual, personnel responsible for maintaining this publication in current status will ascertain that all previous changes have been received and incorporated. Action should be taken promptly if the publication is incomplete. This page reflects the current status of the complete manual. All pages listed must be in the manual to make this publication current and complete.

TABLE OF CONTENTS

| <u>PARAGRAPH</u> | <u>TITLE</u> | <u>PAGE</u> | <u>PARAGRAPH</u> | <u>TITLE</u> | <u>PAGE</u> |
|------------------|---|-------------|------------------|--|-------------|
| | INTRODUCTION | | 1-29 | Turbopump Oxidizer Pump Description..... | 1-16 |
| 1 | <u>F-1 MANUALS--THEIR SUPPORT FUNCTIONS</u> | x | 1-32 | Turbopump Fuel Pump Description... | 1-16A |
| <u>1</u> | F-1 Rocket Engine and S-IC Stage Positions..... | ix | 1-35 | Turbopump Turbine Description.... | 1-17 |
| <u>2</u> | How to Maintain Your Manual..... | xiv | 1-39 | Bearing Coolant Control Valve Description..... | 1-17 |
| <u>2</u> | <u>CONFIGURATION IDENTIFICATION</u> | xv1 | 1-40 | Turbopump Fuel Inlet Elbow Description..... | 1-19 |
| <u>2</u> | MD System..... | xv1 | 1-41 | Oxidizer Valve Description..... | 1-19 |
| 3 | <u>CONFIGURATION CHANGES--MANUAL EFFECTIVITY</u> | xvi | 1-46 | Fuel Valve Description..... | 1-19 |
| | SECTION I DESCRIPTION AND OPERATION | | <u>1-22</u> | Oxidizer Valve and Fuel Valve Leading Particulars..... | 1-21 |
| 1-2 | <u>F-1 ROCKET ENGINE</u> | 1-1 | 1-49 | Oxidizer High-Pressure Duct Description..... | 1-21 |
| <u>1-1</u> | F-1 Rocket Engine, Number One Side | 1-2 | 1-51 | Fuel High-Pressure Duct Description..... | 1-21 |
| <u>1-2</u> | F-1 Rocket Engine, Number Two Side | 1-3 | 1-53 | Engine Interface Panel Description | 1-21 |
| <u>1-3</u> | F-1 Rocket Engine, Forward End.... | 1-4 | 1-55 | <u>IGNITION SYSTEM DESCRIPTION</u> | 1-21 |
| 1-7 | <u>ENGINE PHYSICAL DESCRIPTION</u> | 1-1 | 1-57 | Hypergol Igniter Description..... | 1-25 |
| <u>1-4</u> | F-1 Engine Schematic..... | 1-5 | 1-59 | Pyrotechnic Igniter Description... | 1-25 |
| <u>1-5</u> | Engine Leading Particulars (Engines Incorporating MD128 or MD174 Change)..... | 1-6 | 1-61 | <u>GAS GENERATOR SYSTEM DESCRIPTION</u> .. | 1-25 |
| <u>1-5A</u> | Engine Performance Schematic (Engines Incorporating MD128 or MD174 Change)..... | 1-6A | 1-63 | Gas Generator Description..... | 1-25 |
| 1-9 | <u>PROPELLANT FEED SYSTEM DESCRIPTION</u> | 1-6B | <u>1-27</u> | Gas Generator Leading Particulars (Engines Incorporating MD128 or MD174 Change)..... | 1-25 |
| 1-11 | Thrust Chamber Assembly Description..... | 1-6B | 1-65 | Gas Generator Ball Valve Description..... | 1-26 |
| <u>1-7</u> | Thrust Chamber Leading Particulars (Engines Incorporating MD128 or MD174 Change)..... | 1-8 | 1-67 | Gas Generator Injector Description | 1-28 |
| <u>1-8</u> | Thrust Chamber and Nozzle Extension..... | 1-9 | 1-68 | Gas Generator Combustor Description..... | 1-28 |
| 1-14 | Thrust Chamber Body Description... | 1-8 | 1-69 | Gas Generator Oxidizer Duct Description..... | 1-29 |
| 1-19 | Thrust Chamber Injector Description..... | 1-9A | 1-70 | Gas Generator Fuel Duct Description..... | 1-29 |
| <u>1-9</u> | Thrust Chamber Injector Compartments and Baffles..... | 1-9A | 1-71 | Heat Exchanger Description..... | 1-29 |
| 1-20 | Thrust Chamber Oxidizer Dome and Manifold Description..... | 1-9B | 1-73 | <u>ENGINE CONTROL SYSTEM DESCRIPTION</u> .. | 1-50 |
| 1-21 | Gimbal Bearing Assembly Description..... | 1-9B | 1-75 | Engine Control Valve Description.. | 1-50 |
| 1-23 | Thrust Chamber Nozzle Extension Description..... | 1-9B | <u>1-32</u> | Engine Control Valve and Redundant Shutdown Valve Schematic..... | 1-51 |
| 1-24 | Turbopump Description..... | 1-11 | 1-82 | Redundant Shutdown Valve Description..... | 1-55 |
| <u>1-16</u> | Turbopump Leading Particulars (Engines Incorporating MD128 or MD174 Change)..... | 1-16 | 1-84 | Checkout Valve Description..... | 1-55 |
| | | | 1-86 | Hypergol Manifold Assembly Description..... | 1-55 |
| | | | <u>1-36</u> | Hypergol Manifold Leading Particulars..... | 1-57 |
| | | | 1-88 | Ignition Monitor Valve Description | 1-55 |
| | | | 1-89 | Igniter Fuel Valve Description.... | 1-55 |

Underlined numbers denote figures.
Underlined titles denote primary paragraphs.

TABLE OF CONTENTS
(continued)

| <u>PARAGRAPH</u> | <u>TITLE</u> | <u>PAGE</u> | <u>PARAGRAPH</u> | <u>TITLE</u> | <u>PAGE</u> |
|------------------|--|-------------|------------------|--|-------------|
| 1-90 | <u>FLIGHT INSTRUMENTATION SYSTEM</u> | | 1-161 | <u>ENGINE FLOW AT MAF</u> | 1-66 |
| | <u>DESCRIPTION</u> | 1-35 | 1-163 | Receiving Inspection..... | 1-69 |
| 1-94 | Primary and Auxiliary Junction | | 1-165 | Engine Buildup, Modification, | |
| | Box Description..... | 1-38 | | and Maintenance..... | 1-69 |
| 1-96 | Pressure Transducer Description. | 1-39 | 1-170 | Single-Engine Checkout..... | 1-69 |
| 1-98 | Temperature Transducer | | 1-172 | Wrap-Around Duct and Hose | |
| | Description..... | 1-40 | | Installation..... | 1-70 |
| 1-100 | Oxidizer Flowmeter Description.. | 1-40 | 1-174 | Engine Installation at MAF..... | 1-70 |
| 1-102 | Speed Transducer Description.... | 1-42 | 1-178 | Installed-Engine Inspection | |
| | | | | Before Stage Shipment to MTF.... | 1-70 |
| 1-104 | <u>THERMAL INSULATION SYSTEM</u> | | 1-180 | <u>STAGE SHIPMENT TO MTF</u> | 1-71 |
| | <u>DESCRIPTION</u> | 1-43 | | | |
| 1-109 | <u>ENGINE PURGE AND DRAIN SYSTEM</u> | | 1-182 | <u>STAGE FLOW AT MTF</u> | 1-73 |
| | <u>DESCRIPTION</u> | 1-45 | 1-184 | Stage Installation in Test Stand | 1-73 |
| 1-111 | Service Mode Purge System | | 1-186 | Engine Receiving Inspection.... | 1-73 |
| | Description..... | 1-45 | 1-188 | Installation of Nozzle Exten- | |
| 1-115 | Operational Mode Purge System | | | sions, Slave Hardware, and MTF | |
| | Description..... | 1-45 | | Static Test Instrumentation.... | 1-73 |
| 1-115 | Service Mode Drain System | | 1-190 | Stage Pre-Static Checkout..... | 1-73 |
| | Description..... | 1-45 | 1-192 | Static Test..... | 1-73 |
| 1-117 | Operational Mode Drain System | | 1-194 | Engine Inspection After Static | |
| | Description..... | 1-47 | | Test..... | 1-75 |
| | | | 1-196 | Static Test Data Review..... | 1-75 |
| 1-119 | <u>ENGINE OPERATION REQUIREMENTS</u> ... | 1-47 | 1-198 | Turbopump Preservation..... | 1-75 |
| <u>1-50</u> | Engine Facility Requirements.... | 1-51 | 1-200 | Removal of Nozzle Extensions, | |
| | | | | Slave Hardware, and MTF Static | |
| 1-121 | <u>ENGINE OPERATION</u> | 1-47 | | Test Instrumentation..... | 1-75 |
| <u>1-51</u> | Engine Start Sequence (Typical | | 1-202 | Installed-Engine Inspection | |
| | Single Engine)..... | 1-52 | | Before Stage Shipment to MAF.... | 1-75 |
| <u>1-52</u> | Engine Cutoff Sequence (Typical | | 1-204 | Stage Removal From Test Stand... | 1-76 |
| | Single Engine)..... | 1-54 | | | |
| 1-125 | Engine Preparation Stage..... | 1-47 | 1-206 | <u>STAGE SHIPMENT TO MAF</u> | 1-76 |
| 1-125 | Engine Start and Ignition Stage. | 1-56 | | | |
| 1-129 | Engine Mainstage..... | 1-56 | 1-208 | <u>STAGE FLOW AT MAF</u> | 1-76 |
| 1-151 | Engine Cutoff..... | 1-56 | 1-210 | Engine Receiving Inspection.... | 1-76 |
| | | | 1-212 | Engine Refurbishment..... | 1-76 |
| 1-154 | <u>F-1 ENGINE FLOW</u> | 1-63 | 1-214 | Stage Storage..... | 1-76 |
| | | | 1-216 | Post-Static Checkout..... | 1-78 |
| 1-158 | <u>ENGINE FLOW BEFORE FIELD</u> | | 1-218 | Installed-Engine Inspection | |
| | <u>DELIVERY</u> | 1-64 | | Before Stage Shipment to KSC.... | 1-78 |
| 1-139 | Customer Acceptance Inspection.. | 1-64 | | | |
| 1-141 | Post-DD250 Maintenance or | | 1-220 | <u>STAGE SHIPMENT TO KSC</u> | 1-78 |
| | Modification..... | 1-64 | | | |
| 1-143 | <u>ENGINE SHIPMENT TO MAF</u> | 1-64 | 1-222 | <u>STAGE FLOW AT KSC</u> | 1-78 |
| 1-145 | Preparation for Shipment..... | 1-64 | 1-224 | Stage Installation Onto Launch | |
| 1-147 | Shipping by Truck..... | 1-64 | | Umbilical Tower (LUT)..... | 1-80 |
| 1-149 | Shipping by Ship..... | 1-64 | 1-226 | Engine Receiving Inspection.... | 1-80 |
| | | | 1-228 | Loose Equipment Installation... | 1-80 |
| 1-151 | <u>RECEIVING ENGINE AT MAF</u> | 1-66 | 1-230 | Modification and Maintenance.... | 1-80 |
| 1-153 | Receiving by Truck..... | 1-66 | 1-232 | Stage Functional Test..... | 1-80 |
| 1-155 | Receiving by Ship..... | 1-66 | 1-234 | Thermal Insulation Installation. | 1-81 |
| | | | | | |
| 1-157 | <u>UNASSIGNED-ENGINE FLOW AT MAF</u> ... | 1-66 | 1-236 | <u>SATURN V VEHICLE FLOW AT KSC</u> | 1-81 |
| 1-159 | Storage Receiving Inspection.... | 1-66 | 1-238 | Vehicle Testing..... | 1-81 |
| | | | | | |
| | | | 1-240 | <u>TRANSFERRING VEHICLE TO LAUNCH</u> | |
| | | | | <u>PAD</u> | 1-81 |

Underlined numbers denote figures.
Underlined titles denote primary paragraphs.

TABLE OF CONTENTS
(continued)

| PARAGRAPH | TITLE | PAGE | PARAGRAPH | TITLE | PAGE |
|-------------|---|------|--------------|---|------|
| 1-242 | Launch Preparations and Testing. | 1-83 | <u>2-9K</u> | Estimated Oxidizer Outlet Temperature Transient for Heat Exchanger..... | 2-8K |
| 1-244 | SATURN V VEHICLE LAUNCH..... | 1-83 | <u>2-9L</u> | Estimated Oxidizer Outlet Temperature Versus Oxidizer Flowrate for Steady-State Operation of Heat Exchanger..... | 2-8L |
| 1-246 | Post-Flight Data Evaluation..... | 1-83 | <u>2-9M</u> | Estimated Oxidizer Outlet Pressure Versus Oxidizer Flowrate for Steady-State Operation of Heat Exchanger..... | 2-8M |
| 1-248 | <u>UNSCHEDULED MAINTENANCE FLOW....</u> | 1-83 | <u>2-16</u> | Hydraulic Control System Nominal Flow and Pressure Values..... | 2-6 |
| 1-250 | Unscheduled Engine Repair and Servicing..... | 1-83 | <u>2-10</u> | Hydraulic Flowrate at Nominal Control System Values..... | 2-9 |
| 1-252 | Component Repair..... | 1-84 | | | |
| 1-254 | Support Hardware..... | 1-84 | | | |
| | SECTION II INTERFACE DESIGN CRITERIA | | | | |
| <u>2-2</u> | <u>DESIGN PERFORMANCE</u> | | <u>2-18</u> | <u>ENVIRONMENTAL CONDITIONS.....</u> | 2-6 |
| | <u>CHARACTERISTICS.....</u> | 2-1 | <u>2-19</u> | Storage and Handling Temperature | 2-6 |
| <u>2-4</u> | Rocket Engine Ratings..... | 2-1 | <u>2-21</u> | Storage and Handling Attitude... | 2-6 |
| <u>2-1</u> | Rocket Engine Ratings at Standard Sea-Level Conditions... | 2-1 | <u>2-23</u> | Standby Exposure..... | 2-6 |
| <u>2-6</u> | Nominal Altitude Performance.... | 2-1 | <u>2-27</u> | Ground Hydraulic Fluid Supply Temperature..... | 2-9 |
| <u>2-8</u> | Oxidizer Pump Cavitation..... | 2-1 | <u>2-29</u> | Thermal Insulation Cocoon Environmental Conditioning Envelope..... | 2-10 |
| <u>2-10</u> | Fuel Pump Cavitation..... | 2-1 | <u>2-11</u> | Recommended Thermal Insulation Cocoon Purge Operating Range Envelope..... | 2-10 |
| <u>2-12</u> | Turbopump Inlet Pressure Requirements..... | 2-1 | <u>2-31</u> | <u>MASS PROPERTIES DATA.....</u> | 2-10 |
| <u>2-6</u> | Acceptable Pump Inlet Propellant Pressures for Starting Engine... | 2-6 | <u>2-33</u> | Weight Status..... | 2-10 |
| <u>2-14</u> | Heat Exchanger Performance..... | 2-6 | <u>2-12</u> | Major Component Weight List..... | 2-10 |
| <u>2-7</u> | Heat Exchanger Flowrates..... | 2-6 | <u>2-13</u> | Engine Weight Status..... | 2-11 |
| <u>2-8</u> | Helium Temperature Versus Flow and Accumulated Engine Test Duration Curve..... | 2-7 | <u>2-35</u> | Engine Coordinate Axes..... | 2-11 |
| <u>2-9</u> | LOX Temperature Versus Flow and Accumulated Engine Test Duration Curve..... | 2-8 | <u>2-14</u> | Coordinate Axis Diagram..... | 2-12 |
| <u>2-9A</u> | Estimated Helium Inlet Temperature Transient for Heat Exchanger..... | 2-8A | <u>2-37</u> | Center of Gravity and Inertia Data..... | 2-11 |
| <u>2-9B</u> | Estimated Helium Flowrate Transient for Heat Exchanger.... | 2-8B | <u>2-18</u> | Weight, Center of Gravity, Moment of Inertia, and Product of Inertia Data (Engines F-2029 Through F-2042)..... | 2-12 |
| <u>2-9D</u> | Estimated Helium Outlet Temperature Transient for Heat Exchanger..... | 2-8C | <u>2-19</u> | Weight, Center of Gravity, Moment of Inertia, and Product of Inertia Data (Engines F-2045 Through F-2065)..... | 2-15 |
| <u>2-9F</u> | Estimated Helium Effectiveness Versus Helium Flowrate for Steady-State Operation of Heat Exchanger..... | 2-8D | <u>2-20</u> | Weight, Center of Gravity, Moment of Inertia, and Product of Inertia Data (Engines F-2066 Through F-2089)..... | 2-15 |
| <u>2-9H</u> | Estimated Helium Pressure Loss Versus Helium Flowrate for Steady-State Operation of Heat Exchanger..... | 2-8E | <u>2-20A</u> | Weight, Center of Gravity, Moment of Inertia, and Product of Inertia Data (Engines F-2045-1 and F-2090 Through F-2098)..... | 2-14 |
| <u>2-9J</u> | Estimated Oxidizer Flowrate Transient for Heat Exchanger.... | 2-8J | | | |

Underlined numbers denote figures.
Underlined titles denote primary paragraphs.

TABLE OF CONTENTS
(continued)

| <u>PARAGRAPH</u> | <u>TITLE</u> | <u>PAGE</u> | <u>PARAGRAPH</u> | <u>TITLE</u> | <u>PAGE</u> |
|------------------|---|-------------|------------------|--|-------------|
| 3-26 | Re-Orificing With No Change in Fuel Pump Operating Conditions.. | 3-25 | <u>3-48</u> | <u>ENGINE TEST INSTRUMENTATION</u> | 3-55 |
| 3-27 | Re-Orificing With Changes in Fuel Pump Inlet Conditions..... | 3-25 | <u>3-46</u> | Engine Instrumentation Parameters | 3-55 |
| 3-28 | Re-Orificing With Changes in Turbopump Speed..... | 3-25 | | APPENDIX | |
| 3-29 | <u>HEAT EXCHANGER PERFORMANCE EVALUATION AND PREDICTION</u> | 3-25 | | MANUAL DATA SUPPLEMENTS | A-1 |
| 3-31 | Heat Exchanger Computer Program Options..... | 3-27 | | | |
| <u>3-29</u> | Heat Exchanger Performance Evaluation and Prediction Input Data Requirements..... | 3-26 | | | |
| 3-38 | <u>ENGINE INFLUENCE COEFFICIENTS</u> ... | 3-39 | | | |
| <u>3-40</u> | RP-1 Fuel Density Versus Temperature..... | 3-42 | | | |
| <u>3-41</u> | Oxidizer Density Versus Temperature..... | 3-42 | | | |
| 3-40 | Calculations Involving a Typical Engine..... | 3-41 | | | |
| 3-42 | Calculations Involving a Specific Engine..... | 3-41 | | | |
| 3-43A | Test Trend Corrections..... | 3-41 | | | |
| <u>3-41A</u> | Turbine Nozzle Area Change Versus Burn Time (Engines F-2029 Through F-2065) | 3-44 | | | |
| <u>3-41B</u> | Turbine Efficiency Ratio Curve Change Versus Burn Time (Engines F-2029 Through F-2065)..... | 3-44 | | | |
| <u>3-41C</u> | Thrust Trend for Flight (Engines F-2029 Through F-2065) | 3-44A | | | |
| 3-44 | Nonlinear Corrections | 3-43 | | | |
| <u>3-42</u> | C* Correction Curve (Actual) (Engines F-2029 Through F-2065). | 3-44A | | | |
| <u>3-44</u> | Turbine Nozzle Area Change Versus Burn Time (Engines F-2066 and Subsequent) | 3-44C | | | |
| <u>3-44A</u> | Turbine Efficiency Ratio Curve Change Versus Burn Time (Engines F-2066 and Subsequent) | 3-44C | | | |
| <u>3-44B</u> | Thrust Trend for Flight Engines (Engines F-2066 and Subsequent). | 3-44D | | | |
| <u>3-44C</u> | C* Correction Curve (Actual) (Engines F-2066 and Subsequent). | 3-45 | | | |
| 3-46 | Component Replacement Effects on Engine Performance at Sea Level | 3-43 | | | |
| <u>3-45</u> | Example of Calculations Required to Determine Deviations in Engine Performance Due to Component Replacement | 3-46 | | | |

Underlined numbers denote figures.
Underlined titles denote primary paragraphs.

LIST OF ILLUSTRATIONS

| <u>FIGURE</u> | <u>TITLE</u> | <u>PAGE</u> | <u>FIGURE</u> | <u>TITLE</u> | <u>PAGE</u> |
|---------------|---|-------------|---------------|---|-------------|
| 1 | F-1 Rocket Engine and S-IC Stage Positions..... | ix | 1-31 | Heat Exchanger..... | 1-29 |
| 2 | How to Maintain Your Manual..... | xiv | 1-32 | Engine Control Valve and Redundant Shutdown Valve Schematic..... | 1-31 |
| 3 | MD System..... | xvi | 1-33 | Redundant Shutdown Valve..... | 1-34 |
| 4 | Configuration Changes--Manual Effectivity..... | xvii | 1-34 | Checkout Valve..... | 1-34 |
| 1-1 | F-1 Rocket Engine, Number One Side..... | 1-2 | 1-35 | Hypergol Manifold..... | 1-36 |
| 1-2 | F-1 Rocket Engine, Number Two Side..... | 1-3 | 1-36 | Hypergol Manifold Leading Particulars..... | 1-37 |
| 1-3 | F-1 Rocket Engine, Forward End... | 1-4 | 1-37 | Ignition Monitor Valve..... | 1-37 |
| 1-4 | F-1 Engine Schematic..... | 1-5 | 1-38 | Flight Instrumentation System Parameters..... | 1-38 |
| 1-5 | Engine Leading Particulars (Engines Incorporating MD128 or MD174 Change)..... | 1-6 | 1-39 | Primary Junction Box..... | 1-39 |
| 1-5A | Engine Performance Schematic (Engines Incorporating MD128 or MD174 Change)..... | 1-6A | 1-40 | Auxiliary Junction Box..... | 1-39 |
| 1-6 | Thrust Chamber Assembly..... | 1-7 | 1-41 | Pressure Transducer..... | 1-40 |
| 1-7 | Thrust Chamber Leading Particulars (Engines Incorporating MD128 or MD174 Change)..... | 1-8 | 1-42 | Temperature Transducers..... | 1-41 |
| 1-8 | Thrust Chamber and Nozzle Extension..... | 1-9 | 1-43 | Oxidizer Flowmeter..... | 1-42 |
| 1-9 | Thrust Chamber Injector Compartments and Baffles..... | 1-9A | 1-44 | Speed Transducer..... | 1-43 |
| 1-10 | Thrust Chamber Oxidizer Dome..... | 1-10 | 1-45 | Engine Thermal Insulation..... | 1-44 |
| 1-11 | Gimbal Bearing..... | 1-11 | 1-46 | Engine Purge and Drain Schematic.. | 1-46 |
| 1-12 | Thrust Chamber Nozzle Extension.. | 1-12 | 1-47 | Engine Fuel and Control Fluid Overboard Drain Schematic (Engines Not Incorporating MD145 Change)... | 1-48 |
| 1-13 | Turbopump (Inboard)..... | 1-13 | 1-47A | Engine Fuel and Control Fluid Overboard Drain Schematic (Engines Incorporating MD145 Change)..... | 1-48A |
| 1-14 | Turbopump (Outboard)..... | 1-14 | 1-48 | Fuel Drain Manifold..... | 1-49 |
| 1-15 | Turbopump Cutaway..... | 1-15 | 1-49 | Engine Purge and Oxidizer Overboard Drain Schematic..... | 1-50 |
| 1-16 | Turbopump Leading Particulars (Engines Incorporating MD128 or MD174 Change)..... | 1-16 | 1-50 | Engine Facility Requirements..... | 1-51 |
| 1-17 | Oxidizer Pump and Fuel Pump..... | 1-16B | 1-51 | Engine Start Sequence (Typical Single Engine)..... | 1-52 |
| 1-18 | Oxidizer Pump and Fuel Pump Bearings..... | 1-16B | 1-52 | Engine Cutoff Sequence (Typical Single Engine)..... | 1-54 |
| 1-19 | Fuel Pump and Turbine..... | 1-18 | 1-53 | Engine Preparation Complete (Typical Single Engine)..... | 1-55 |
| 1-20 | Bearing Coolant Control Valve.... | 1-18 | 1-54 | Engine Ignition Stage..... | 1-57 |
| 1-21 | Oxidizer Valve..... | 1-20 | 1-55 | Engine Mainstage..... | 1-58 |
| 1-22 | Oxidizer Valve and Fuel Valve Leading Particulars..... | 1-21 | 1-56 | Engine Cutoff..... | 1-60 |
| 1-23 | Fuel Valve..... | 1-22 | 1-57 | Engine Start Sequence Flow (Typical)..... | 1-61 |
| 1-24 | Engine Interface Panel..... | 1-23 | 1-58 | Engine Cutoff Sequence Flow (Typical)..... | 1-62 |
| 1-25 | Hypergol Igniter..... | 1-24 | 1-59 | F-1 Engine Flow..... | 1-63 |
| 1-26 | Pyrotechnic Igniter..... | 1-24 | 1-60 | Engine Shipment to MAF..... | 1-65 |
| 1-27 | Gas Generator Leading Particulars (Engines Incorporating MD128 or MD174 Change)..... | 1-25 | 1-61 | Receiving Engine at MAF..... | 1-67 |
| 1-28 | Gas Generator..... | 1-26 | 1-62 | Engine Flow at MAF..... | 1-68 |
| 1-29 | Gas Generator Ball Valve..... | 1-27 | 1-63 | Engine Installation at MAF..... | 1-71 |
| 1-30 | Gas Generator Injector and Combustor..... | 1-28 | 1-64 | Stage Shipment to MTF..... | 1-72 |
| | | | 1-65 | Stage Flow at MTF..... | 1-74 |
| | | | 1-66 | Stage Flow at MAF..... | 1-77 |
| | | | 1-67 | Stage Flow at KSC..... | 1-79 |
| | | | 1-68 | Saturn V Vehicle Flow at KSC..... | 1-82 |

LIST OF ILLUSTRATIONS
(continued)

| <u>FIGURE</u> | <u>TITLE</u> | <u>PAGE</u> | <u>FIGURE</u> | <u>TITLE</u> | <u>PAGE</u> |
|---------------|--|-------------|---------------|---|-------------|
| 2-1 | Rocket Engine Ratings at Standard Sea-Level Conditions.... | 2-1 | 2-15 | (Deleted) | |
| 2-2 | (Deleted) | | 2-16 | (Deleted) | |
| 2-3 | Nominal Altitude Performance..... | 2-3 | 2-17 | (Deleted) | |
| 2-4 | Oxidizer Pump Cavitation Characteristics..... | 2-4 | 2-18 | Weight, Center of Gravity, Moment of Inertia, and Product of Inertia Data (Engines F-2029 Through F-2042)..... | 2-12 |
| 2-5 | Fuel Pump Cavitation Characteristics..... | 2-5 | 2-19 | Weight, Center of Gravity, Moment of Inertia, and Product of Inertia Data (Engines F-2043 Through F-2065)..... | 2-13 |
| 2-6 | Acceptable Pump Inlet Propellant Pressures for Starting Engine.... | 2-6 | 2-20 | Weight, Center of Gravity, Moment of Inertia, and Product of Inertia Data (Engines F-2066 Through F-2089)..... | 2-13 |
| 2-7 | Heat Exchanger Flowrates..... | 2-6 | 2-20A | Weight, Center of Gravity, Moment of Inertia, and Product of Inertia Data (Engines F-2045-1 and F-2090 Through F-2098)..... | 2-14 |
| 2-8 | Helium Temperature Versus Flow and Accumulated Engine Test Duration Curve..... | 2-7 | 2-21 | Operating and Servicing Interface Connections..... | 2-15 |
| 2-9 | L ₀ X Temperature Versus Flow and Accumulated Engine Test Duration Curve..... | 2-8 | 2-22 | Engine Envelope Dimensions..... | 2-23 |
| 2-9A | Estimated Helium Inlet Temperature Transient for Heat Exchanger | 2-8A | 2-23 | Electrical Interface Requirements. | 2-24 |
| 2-9B | Estimated Helium Flowrate Transient for Heat Exchanger.... | 2-8B | 2-24 | Instrumentation Tap Locations.... | 2-47 |
| 2-9C | (Deleted) | | 2-25 | Seal Application (Typical)..... | 2-55 |
| 2-9D | Estimated Helium Outlet Temperature Transient for Heat Exchanger | 2-8C | 2-26 | System Joint and Seal Schematic... | 2-57 |
| 2-9E | (Deleted) | | 2-27 | Purge and Drain Joint and Seal Schematic..... | 2-70 |
| 2-9F | Estimated Helium Effectiveness Versus Helium Flowrate for Steady-State Operation of Heat Exchanger..... | 2-8D | 3-1 | Nominal Engine Performance Values at Sea Level and Standard Turbo-pump Inlet Conditions..... | 3-1 |
| 2-9G | (Deleted) | | 3-2 | Nominal Thrust Buildup Characteristics..... | 3-2 |
| 2-9H | Estimated Helium Pressure Loss Versus Helium Flowrate for Steady-State Operation of Heat Exchanger..... | 2-8E | 3-3 | Gimbal Buildup Characteristics.... | 3-2 |
| 2-9J | Estimated Oxidizer Flowrate Transient for Heat Exchanger.... | 2-8J | 3-4 | Gimbal Supply Pressure Versus Sea-Level Thrust..... | 3-3 |
| 2-9K | Estimated Oxidizer Outlet Temperature Transient for Heat Exchanger..... | 2-8K | 3-5 | Nominal Thrust Decay Characteristics..... | 3-3 |
| 2-9L | Estimated Oxidizer Outlet Temperature Versus Oxidizer Flowrate for Steady-State Operation of Heat Exchanger..... | 2-8L | 3-6 | Nominal Gimbal Supply Pressure Decrease Characteristics..... | 3-4 |
| 2-9M | Estimated Oxidizer Outlet Pressure Versus Oxidizer Flowrate for Steady-State Operation of Heat Exchanger.... | 2-8M | 3-7 | (Deleted) | |
| 2-10 | Hydraulic Flowrate at Nominal Control System Values..... | 2-9 | 3-8 | Sea-Level Specific Impulse Versus Thrust at Nominal Mixture Ratio and Temperature..... | 3-4 |
| 2-11 | Recommended Thermal Insulation Cocoon Purge Operating Range Envelope..... | 2-10 | 3-9 | (Deleted) | |
| 2-12 | Major Component Weight List..... | 2-10 | 3-10 | Sea-Level Characteristic Velocity Versus Thrust at Nominal Mixture Ratio and Temperature (Engines Not Incorporating MD128 or MD174 Change)..... | 3-5 |
| 2-13 | Engine Weight Status..... | 2-11 | 3-11 | Sea-Level Characteristic Velocity Versus Thrust at Nominal Mixture Ratio and Temperature (Engines Incorporating MD128 or MD174 Change)..... | 3-3 |
| 2-14 | Coordinate Axis Diagram..... | 2-12 | | | |

LIST OF ILLUSTRATIONS
(continued)

| <u>FIGURE</u> | <u>TITLE</u> | <u>PAGE</u> | <u>FIGURE</u> | <u>TITLE</u> | <u>PAGE</u> |
|---------------|---|-------------|---------------|---|-------------|
| 3-12 | Sea-Level Thrust and Thrust Coefficient Versus Chamber Pressure at Nominal Mixture Ratio and Temperature (Engines Not Incorporating MD128 or MD174 Change)..... | 3-6 | 3-39 | Engine Influence Coefficients (Predicted) (Engines F-2029 Through F-2065) | 3-40 |
| 3-12A | Sea-Level Thrust and Thrust Coefficient Versus Chamber Pressure at Nominal Mixture Ratio and Temperature (Engines Incorporating MD128 or MD174 Change)..... | 3-6A | 3-40 | RP-1 Fuel Density Versus Temperature | 3-41 |
| 3-13 | Nominal Thrust Chamber Performance Values..... | 3-7 | 3-41 | Oxidizer Density Versus Temperature | 3-42 |
| 3-14 | Nominal Turbopump Performance Values..... | 3-7 | 3-41A | Turbine Nozzle Area Change Versus Burn Time (Engines F-2029 Through F-2065) | 3-43 |
| 3-15 | (Deleted) | | 3-41B | Turbine Efficiency Ratio Curve Change Versus Burn Time (Engines F-2029 Through F-2056) | 3-44 |
| 3-16 | Oxidizer Pump Developed Head Versus Volumetric Flowrate..... | 3-8 | 3-41C | Thrust Trend for Flight (Engines F-2029 Through F-2065) | 3-44A |
| 3-17 | (Deleted) | | 3-42 | C* Correction Curve (Actual) (Engines F-2029 Through F-2065) .. | 3-44A |
| 3-18 | Fuel Pump Developed Head Versus Volumetric Flowrate..... | 3-9 | 3-43 | Engine Influence Coefficients (Predicted) (Engines F-2066 and Subsequent) | 3-44B |
| 3-19 | Nominal Gas Generator Performance Values..... | 3-9 | 3-44 | Turbine Nozzle Area Change Versus Burn Time (Engines F-2066 and Subsequent) | 3-44C |
| 3-20 | Nominal Heat Exchanger Performance Values..... | 3-9 | 3-44A | Turbine Efficiency Ratio Curve Change Versus Burn Time (Engines F-2066 and Subsequent) | 3-44C |
| 3-21 | Nominal Valve Opening Times for Mainstage..... | 3-10 | 3-44B | Thrust Trend for Flight Engines (Engines F-2066 and Subsequent) .. | 3-44D |
| 3-22 | Nominal Thrust Buildup and Approximate Propellant Consumption Values for Mainstage..... | 3-10 | 3-44C | C* Correction Curve (Actual) (Engines F-2066 and Subsequent) .. | 3-45 |
| 3-22A | Nominal Start Times From Engine Control Valve Open Signal..... | 3-10 | 3-45 | Example of Calculations Required to Determine Deviations in Engine Performance Due to Component Replacement | 3-46 |
| 3-23 | Engine Schematic (Pre-Start)..... | 3-17 | 3-46 | Engine Instrumentation Parameters. | 3-55 |
| 3-24 | Engine Schematic (Ignition)..... | 3-19 | | | |
| 3-25 | Engine Schematic (Mainstage)..... | 3-20 | | | |
| 3-26 | Engine Drain and Purge Schematic. | 3-21 | | | |
| 3-27 | Nominal Cutoff Times From Engine Control Valve Stop Signal..... | 3-22 | | | |
| 3-28 | Nominal Thrust Decay Time From Engine Control Valve Closing Signal..... | 3-22 | | | |
| 3-28A | Nominal Thrust Decay and Cutoff Impulse..... | 3-22 | | | |
| 3-29 | Heat Exchanger Performance Evaluation and Prediction Input Data Requirements..... | 3-26 | | | |
| 3-30 | (Deleted) | | | | |
| 3-31 | (Deleted) | | | | |
| 3-32 | (Deleted) | | | | |
| 3-33 | (Deleted) | | | | |
| 3-34 | (Deleted) | | | | |
| 3-35 | (Deleted) | | | | |
| 3-36 | (Deleted) | | | | |
| 3-37 | (Deleted) | | | | |
| 3-38 | (Deleted) | | | | |

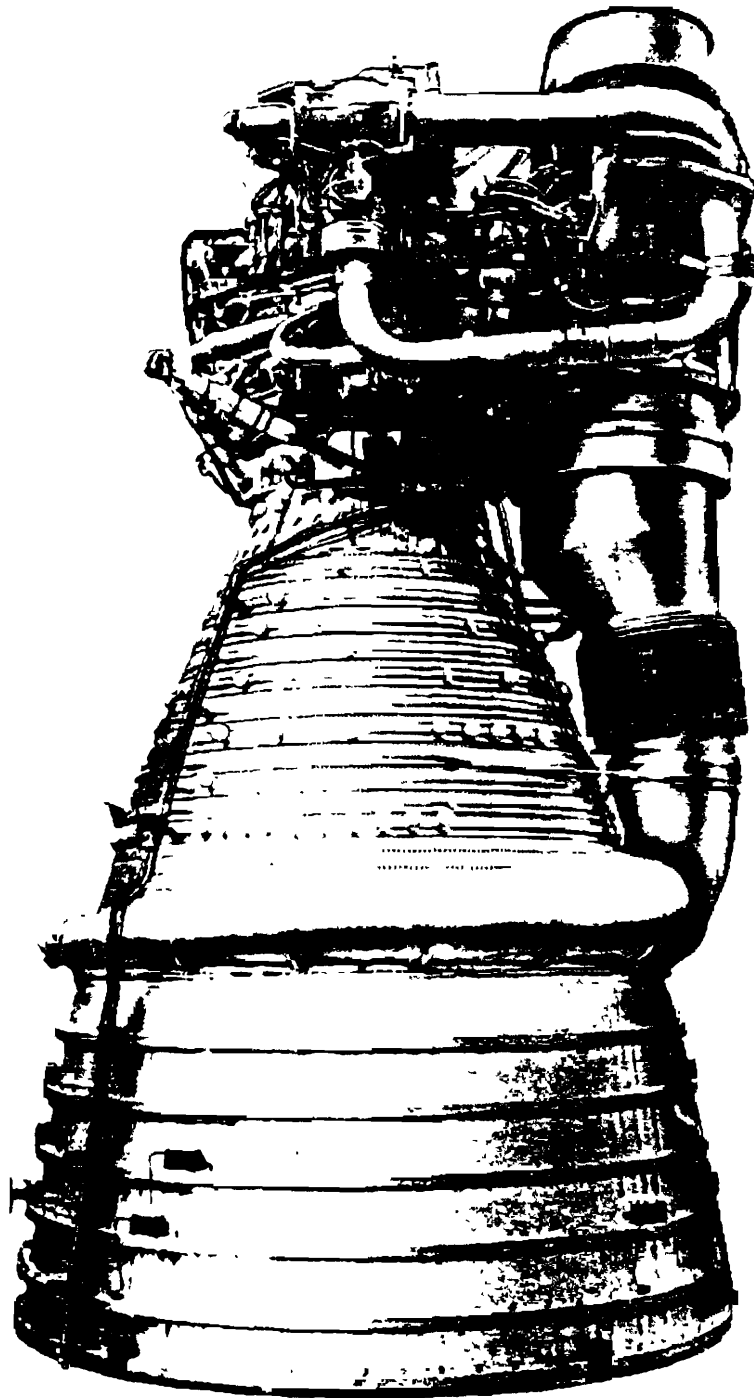

F1-1-23

Figure 1A. F-1 Rocket Engine (Typical Flight Configuration)

Change No. 6 - 14 August 1968

viiiA/viiiB

INTRODUCTION

This manual is one of seven R-3896-series technical manuals prepared to provide official Rocketdyne field support documentation for the operation and maintenance of the F-1 Rocket Engine, Part Number 104001, Serial Numbers F-2029 through F-2098, and its related ground support equipment, designed and manufactured by Rocketdyne, a division of North American Rockwell Corporation, 6633 Canoga Avenue, Canoga Park, California 91304. The information in these manuals was prepared by Logistics Publications & Training Department of Rocketdyne.

This manual contains engineering data detailing engine operation and engine system functions. For stage design criteria, refer to F-1 Engine Interface Document R-6749.

Five F-1 rocket engines are installed on the S-IC stage. Figure 1 shows engine positions relative to stage positions and fin locations.

The instructions in the manuals are used more effectively when each manual is current and complete (see figure 2) and the purpose and scope of each manual is known. The manuals that complete this series, and the nature of the data each provides, are found in the manuals contents and support functions chart.

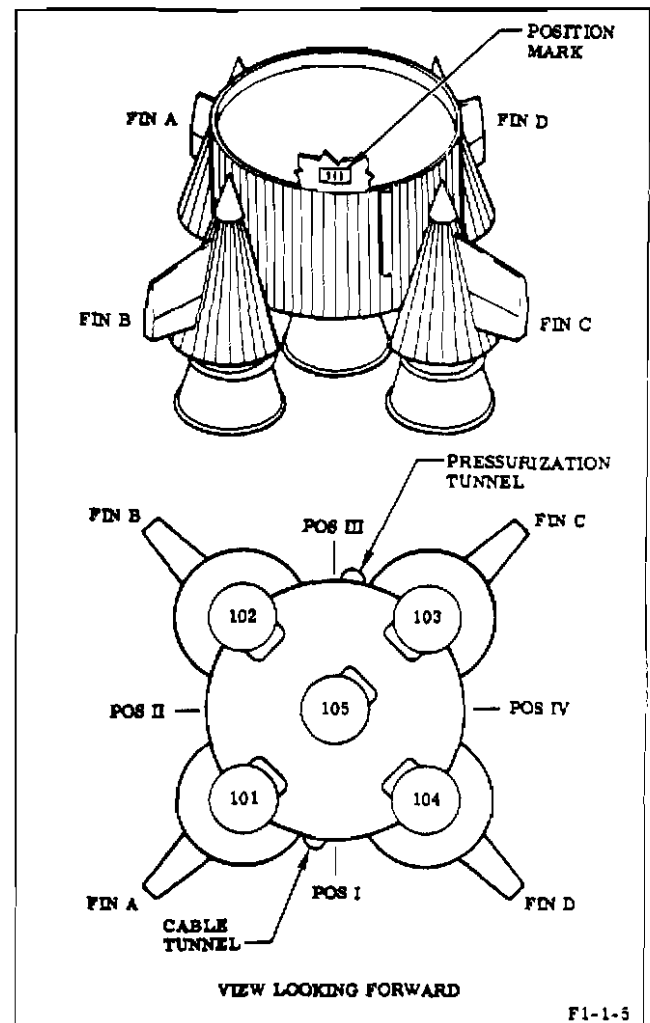

Figure 1. F-1 Rocket Engine and S-IC Stage Positions

1. F-1 MANUALS--THEIR SUPPORT FUNCTIONS.

The contents and support function chart lists all F-1-series technical manuals, describes the support function each manual serves, and lists the section titles of each manual. The chart also explains how the technical data in each manual relates to the support of the engine

and its ground support equipment throughout a normal engine flow, as well as during unscheduled maintenance tasks. Information appearing in one manual is not duplicated in another. Thus, information on the description, operation, and maintenance of ground support equipment is in R-3896-5. However, the instructions for servicing the engine using ground support equipment are in R-3896-3 and R-3896-11.

| Manual | Contents and Support Function | Section and Title |
|--|---|--|
| R-3896-1 F-1 Rocket Engine Data | This manual contains a physical description of the various F-1 engine systems and the individual engine system components, a description of the flow the engine follows from the time it is accepted by the Customer through Apollo/Saturn V launch; data pertaining to engine design characteristics including environmental conditions, attitude, mass properties data, turbopump inlet propellant conditions, and interface connections for mating the engine with the S-IC of the Saturn V vehicle; and nominal engine performance characteristics, methods for predicting engine variable characteristics, and other pertinent information that can be used as an aid for analyzing and/or determining specific engine performance. The manual serves to familiarize the reader with the design and operation of the F-1 engine and serves as a training aid document. | See detailed table of contents for this manual. |
| R-3896-3, Volume I F-1 Rocket Engine Maintenance and Repair | This manual contains general maintenance practices that are peculiar to the engine covered in this volume and to the component repair procedures contained in Volume II of this manual; the use of engine, thrust chamber, and nozzle extension ground support equipment and the tasks necessary to prepare the equipment for maintenance using the applicable pieces of ground support equipment; detailed procedures for component removal, reinstallation, or replacement; and the post-installation test requirements that will verify the integrity of engine systems affected by the removal of individual engine components and | I General Maintenance and Repair II Handling III Component Removal and Installation IV Post-Maintenance Test Requirements |

| Manual | Contents and Support Function | Section and Title |
|---|--|--|
| R-3896-3, Volume I (cont) | lines. This volume and Volume II provide the necessary maintenance and repair data to perform unscheduled maintenance tasks on an uninstalled engine and the required post-maintenance tests to determine that the engine is in an operable condition. | |
| R-3896-3, Volume II F-1 Rocket Engine Maintenance and Repair | This manual contains cleaning, inspecting, repairing, and testing procedures for the individual engine components. This manual provides the data to restore and/or maintain components of the engine in an operable condition for reinstallation on the engine or assignment as a spare. | <ul style="list-style-type: none"> I Quick-Disconnect II Gas Generator III Gas Generator Ball Valve IV Gas Generator Injector Purge and Pump Seal Purge Check Valve V Deleted VI Heat Exchanger VII Heat Exchanger Check Valve VIII Thrust Chamber (Installed) IX Thrust Chamber (Uninstalled) X Thrust OK Pressure Switch XI Inert Prefill Check Valve XII Oxidizer Dome Purge Check Valve XIII Oxidizer Valve XIV Fuel Valve XV Turbopump XVA Turbine XVI Bearing Coolant Control Valve XVII Deleted XVIII Electrical Harness XIX Hypergol Manifold XX Ignition Monitor Valve XXI Checkout Valve XXII Engine Control Valve XXIII Four-Way Solenoid Valve XXIV Thrust Chamber Nozzle Extension XXV Pressure Transducer XXVI Temperature Transducer XXVII Flight Instrumentation Junction Boxes XXVIII Rigid Ducts, Flexible Lines, and Braided Flex Hoses XXIX Redundant Shutdown Valve XXX Volumetric Liquid Oxygen Transducer (Oxidizer Flowmeter) XXXI Gimbal Boot, Insulation Boot, and Insulation Seal |

| Manual | Contents and Support Function | Section and Title |
|--|--|---|
| R-3896-4 F-1 Rocket Engine Illustrated Parts Breakdown | This manual contains illustrative and columnar listings of all parts of the engine that can be disassembled, reassembled, repaired, replaced, or overhauled. This manual locates and identifies the interrelationship of parts, aids in the requisition of replacement parts, and indicates part usage and interchangeability and recommended repair or replacement for the F-1 engine and its individual components and parts. | I Introduction |
| | | II Group Assembly Parts List |
| | | III Numerical Index |
| R-3896-5, Volume I F-1 Rocket Engine Ground Support Equipment Maintenance and Operation | This manual contains safety requirements and general maintenance practices peculiar to the equipment covered in this volume and to equipment and T-tools covered in Volume II of this manual and includes inspection requirements, physical description, operation, intended usage, operating limitations, periodic maintenance, and parts listings with maintenance-level codes for the F-1 engine ground support equipment covered in this volume. This volume provides data to restore and/or maintain the F-1 rocket engine ground support equipment in an operable condition. | I Safety Requirements, General Maintenance, and Handling and Shipping Equipment |
| | | II Hydraulic Pumping Unit G2025 |
| | | III Hydraulic Pumping Unit G2026 |
| | | IV Accumulator Unit G2027 |
| | | V Engine Checkout Console G3142 |
| | | VI Pneumatic Flow Monitors G3130 and G3131 |
| | | VII Engine Vertical Installer G4049 |
| | | VIII Engine Rotating Sling G4050 |
| | | IX Flight Combustion Monitor 703227 |
| | | X Components Test Console G3141 and Components Adapter Set G3143 |
| | | XI Cryogenic Supply Unit G3146 |
| | | XII Pneumatic Flow Testers G3104 and G3104MD1 |
| | | XIII High-Voltage Igniter Tester G3153 and Inert Igniter 9026622 |
| | | XIV Impact Recorder Unit G4090 and 99-9014031 |
| | | XV Components Welding Sets 9026560, 9026561, and 9026570 |

| Manual | Contents and Support Function | Section and Title |
|---|---|--|
| R-3896-5, Volume II F-1 Rocket Engine Ground Support Equipment Maintenance and Operation | This manual contains inspection requirements, physical description, operation, intended usage, operating limitations, periodic maintenance, and parts listing with maintenance-level codes for the F-1 engine ground support equipment end items that are considered tools (ie, test kits, sets, and tools) and T-tools. This volume provides data necessary to determine that those items of ground support equipment covered by this volume and the F-1 field T-tools are in an operable condition. | I Test Kits, Sets, and Tools II T-Tools III Dummy Weight T-Tools |
| R-3896-6 F-1 Rocket Engine Thermal Insulation Installation and Repair | This manual contains a description of the thermal insulation panels, special tools and equipment, installation and removal procedures, access provisions, repair data, and applicable packaging, storage, and handling information. This manual provides information pertinent to the maintenance and repair of F-1 engine thermal insulation. | I Description II Special Tools and Equipment III Installation and Removal (Engines F-2003 Through F-2016) IV Installation and Removal (Engines F-2017 and Subsequent) V Access Provisions VI Repair VII Storage and Handling |
| R-3896-9 F-1 Rocket Engine Transportation | This manual contains procedures for preparing the F-1 rocket engine, nozzle extension, thermal insulation, and miscellaneous engine loose equipment for shipment, and procedures for shipping by truck, air, or water. Included are recommended truck-, air-, and water-transport checklists, which may be used to make sure that procedures and in-transit inspection have been performed. | I Preparation for Shipping II Shipping by Truck Transport III Shipping by Air Transport IV Shipping by Water Transport |
| R-3896-11 F-1 Rocket Engine Operating Instructions | This manual contains complete, authorized field operating requirements that affect F-1 flight engines F-2029 through F-2098 during normal operational flow from engine receipt at MAF through vehicle launch. Specific and general requirements and procedures for normal F-1 engine activities are provided and include acceptability criteria and limits, special constraints, safety precautions, and correct sequences required to satisfactorily accomplish the activities | I Operating Requirements II General Requirements III Operating Procedures |

USE YOUR MANUAL ONLY IF CURRENT AND COMPLETE

Manuals that are not current and complete are not authoritative documents and are not to be used. The following outlines the method for determining whether your manual is current and complete.

A. DETERMINING CURRENCY. To be sure that yours is the latest issue of the manual, refer to Configuration Identification & Status Report, which is revised monthly and lists the technical manual numbers, titles, unincorporated supplements, and latest change or revision dates. Your manual must have a title page with the same or later date than the date shown in the Configuration Identification & Status Report. Your manual must also include the unincorporated supplements listed in the Configuration Identification & Status Report, or if your manual is later than shown in the report, the unincorporated supplements listed in the Manual Data Supplement Record in your manual. If your title page incorporates two dates as illustrated below, compare the change (lower) date. If your manual is not current, obtain a current copy through your technical manual supply system.

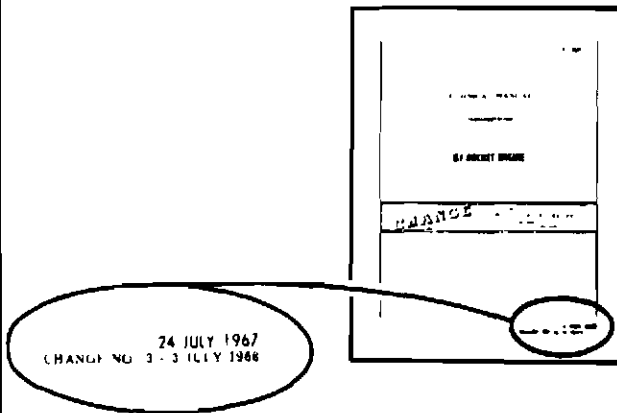

B. DETERMINING COMPLETENESS. To be sure that your manual is complete, make a page-by-page comparison of its pages to those listed in the List of Effective Pages. The List of Effective Pages, which shows the change status since the basic issue or last revision, is found on the alphabetically lettered page(s) immediately following the title page. All pages, except supplements, are

listed with their issue dates. Manual pages that are dated must have the same date as that appearing in the List of Effective Pages for that page. Unchanged pages are listed as "original" and are not dated.

HOW TO KEEP YOUR MANUAL UP-TO-DATE

As design changes are made to the rocket engine and ground support equipment and better methods of maintenance are discovered, your manual is periodically changed, revised, or supplemented. The following steps will help you keep your manual up-to-date:

A. CHANGES. Updating by adding to or partially replacing existing pages is defined as a change. Changes can be identified by the change notice on the new title page.

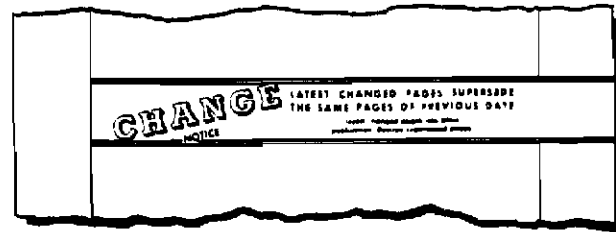

To collate a change, refer to the Filing Instructions sheet issued with the manual and proceed as follows:

1. Remove the pages listed in the "Remove" column of the Filing Instructions sheet from the manual and destroy them. Do not concern yourself with the data on the opposite side of the deleted page since, if this date is not deleted, it is replaced in the change package.
2. Insert all pages listed in the "Insert" column of the Filing Instructions sheet in sequence. Pages with a suffix letter are inserted in alphabetical order following the page with the same basic number; for example, pages 3-14A, 3-14B, etc, follow page 3-14.

GEN-NASA-1A

Figure 2. How to Maintain Your Manual (Sheet 1 of 2)

3. If you are unsure of the status of any page or pages, refer to the List of Effective Pages and make sure your manual contains pages (with the corresponding change dates) listed in the List of Effective Pages.
4. Remove manual supplements that have been incorporated.

NOTE

Incorporated supplements can be determined by reviewing the newly issued Manual Data Supplement Record.

B. REVISIONS. Updating by replacing all the existing pages of a manual is defined as a revision. Revisions can be identified by the replacement notice on the new title page.

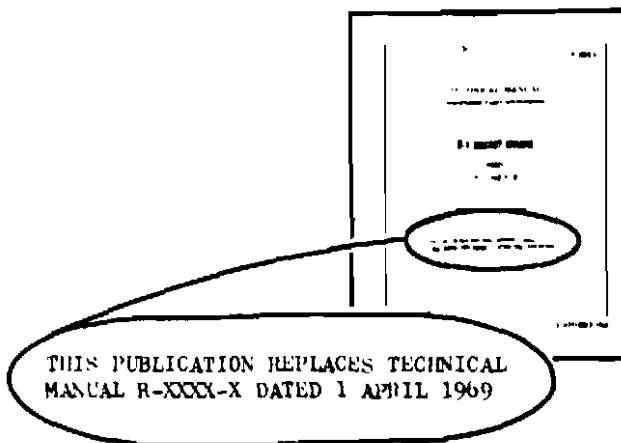

To collate a revision, proceed as follows:

1. Remove and destroy all existing pages of your manual except Manual Data Supplements that have not been incorporated.

NOTE

Unincorporated supplements can be identified by reviewing the Manual Data Supplement Record supplied in the revision.

2. Insert the new pages in your cover.

C. SUPPLEMENTS. Updating that authorizes the addition to, or alteration of, the existing data in your manual is defined as a Manual Data Supplement. Information on how to insert supplements is found in the supplements.

HOW TO KEEP ABREAST OF THE LATEST CHANGES TO TECHNICAL DATA

Changes and/or additions to technical data are identified by a vertical bar (change bar) in the margin of the page adjacent to the changed data. A direct comparison between the new (identified by the change bar) and the old data will help you in identifying specific changes made.

GEN-NASA-2

Figure 2. How to Maintain Your Manual (Sheet 2 of 2)

2. CONFIGURATION IDENTIFICATION

EQUIPMENT CONFIGURATION. The MD identification symbol and the equipment model designation indicate the configuration of the equipment and distinguish it from models incorporating different changes and from basic models. A basic, unchanged configuration of the equipment has no MD identification symbol. MD identification symbols are added as changes affecting configuration are incorporated into the equipment. The MD identification symbol is stamped on the MD plate, which is mounted near the engine nameplate.

MD IDENTIFICATION SYMBOLS. On MD identification plate RD171-1022-0001, the identification symbol is a composite number representing all the changes affecting configuration (MD changes) incorporated or not incorporated into the equipment. The symbol represents a consecutively numbered series of MD changes. Any MD change, or series of MD changes, not incorporated is represented by an "X." Multi-digit numbers are underlined. Two figures together represent the limits of a series of incorporated MD changes. Figure 3 illustrates how MD changes incorporated in the engine are represented by the MD identification symbol.

MD identification plates RD171-1052-0001 through -0006 have preprinted numbers from 1 through 100 on the -0001 plate, 101 through 200 on the -0002 plate, etc. Modifications that are incorporated into the equipment are represented by the letter P (production) or K (kit) stamped in the square directly to the right of the applicable number. Omission of a P or K, indicates that the MD change is not incorporated. A P or K with a bar (-) marked through the letter (~~P~~, ~~K~~) indicates a MD change deleted in its entirety by the incorporation of a later MD change. Figure 3 illustrates how MD changes incorporated into the equipment are represented by the MD identification symbol.

MANUAL REFERENCE. A reference that appears in the manual may refer to a series of MD changes or to an individual MD change; for example, "MD9" refers to MD1 through MD9, but "MD9 change" refers to the individual MD change 9. This latter type of reference, which is illustrated in figure 3, identifies separate sets of information required by differences in configuration. When an MD reference appears in this manual, examine the MD identification symbol on the equipment to determine which set of information is applicable.

3. CONFIGURATION CHANGES--MANUAL EFFECTIVITY.

All approved ECPs (Engineering Change Proposals) and associated MD numbers applicable

to the equipment covered in this manual are listed in figure 4. The date in the last column is the publication date of the manual during which the change made by the ECP was incorporated. When N/A is entered, the ECP does not change the data in the manual. Engine configuration information is in R-5857, Saturn F-1 Configuration Identification & Status Report. Engine serial numbers within this manual are in accordance with Rocketdyne F-1 engine designation. For F-1 engine serial number allocation, refer to the cross-reference index in R-5857.

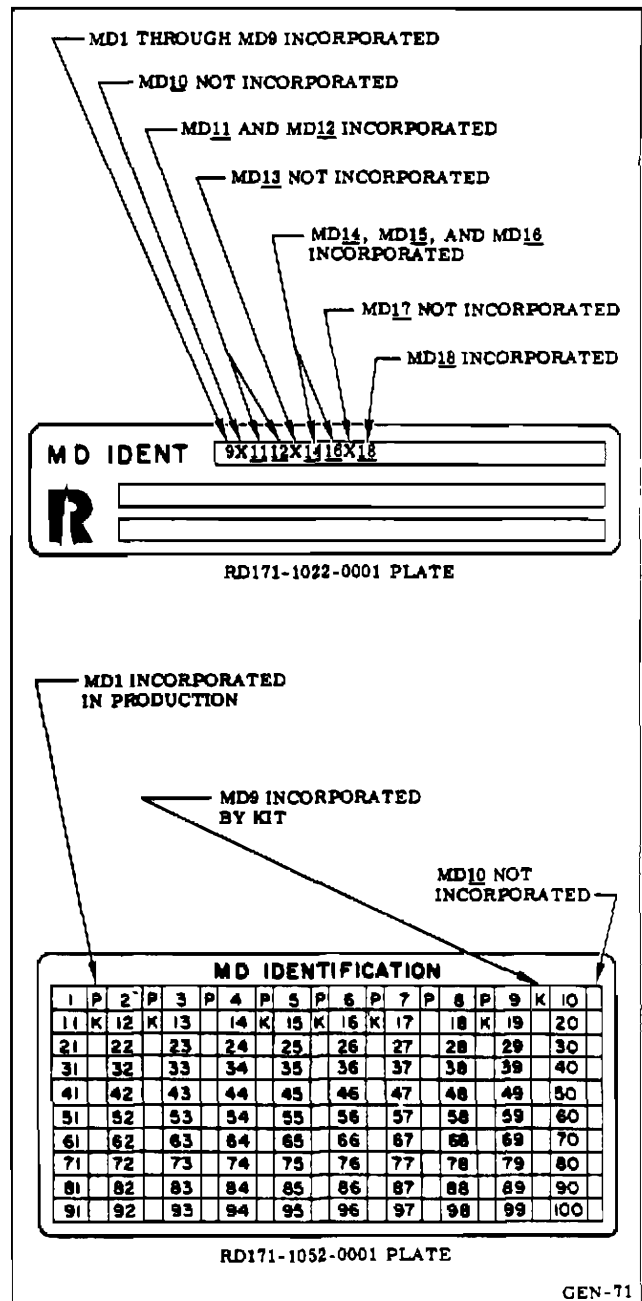

Figure 3. MD System

| Approved ECP No. | MD No. | Incorporated in Manual Dated | Approved ECP No. | MD No. | Incorporated in Manual Dated |
|---------------------|-----------|---------------------------------|---------------------|---------------|---------------------------------|
| F1-38 | <u>37</u> | 17 May 1965 | F1-174 | <u>21</u> | N/A |
| F1-38R1 | -- | N/A | F1-174R1 | -- | N/A |
| F1-39 | <u>11</u> | 8 June 1964 | F1-176 | <u>22</u> | N/A |
| F1-40 | -- | N/A (superseded by F1-254) | F1-180 | <u>34</u> | 27 October 1964 |
| F1-42 | 7 | 8 June 1964 | F1-182 | <u>7</u> | N/A |
| F1-45 | 7 | 8 June 1964 | F1-185 | <u>32</u> | 11 May 1964 |
| F1-56 | 7 | 8 June 1964 | F1-185R1 | -- | N/A |
| F1-57 | 7 | 8 June 1964 | F1-188 | 7 | 27 October 1964 |
| F1-59 | 7 | 8 June 1964 | F1-188R1 | -- | N/A |
| F1-60 | <u>16</u> | N/A | F1-189 | 7 | 27 October 1964 |
| F1-62 | <u>7</u> | 8 June 1964 | F1-191 | 7 | 27 October 1964 |
| F1-64 | 7 | N/A | F1-192 | <u>46</u> | 28 September 1965 |
| F1-65 | 7 | 8 June 1964 | F1-192R1 | -- | N/A |
| F1-67 | <u>10</u> | 8 June 1964 | F1-192R2 | -- | N/A |
| F1-69 | <u>7</u> | 8 June 1964 | F1-193 | 7 | 27 October 1964 |
| F1-71 | 9 | 8 June 1964 | F1-193R1 | -- | N/A |
| F1-74 | 7 | 8 June 1964 | F1-194 | 7 | 27 October 1964 |
| F1-76 | <u>24</u> | 27 October 1964 | F1-195 | 7 | 27 October 1964 |
| F1-76R1 | -- | N/A | F1-196 | <u>29</u> | N/A |
| F1-78 | 7 | 8 June 1964 | F1-197 | <u>20</u> | 27 October 1964 |
| F1-80 | 7 | 8 June 1964 | F1-198 | <u>26</u> | N/A |
| F1-82 | <u>18</u> | 8 June 1964 | F1-198R1 | -- | N/A |
| F1-85 | <u>7</u> | 8 June 1964 | F1-202 | 7 | 27 October 1964 |
| F1-86 | 7 | 8 June 1964 | F1-206 | <u>22, 66</u> | 27 October 1964 |
| F1-90 | 7 | 8 June 1964 | F1-206R1 | -- | N/A |
| F1-91 | 7 | N/A | F1-206R2 | -- | N/A |
| F1-95 | 7 | 8 June 1964 | F1-208 | <u>33</u> | 27 October 1964 |
| F1-97 | 7 | 8 June 1964 | F1-214 | <u>31</u> | 28 September 1965 |
| F1-98 | <u>20</u> | N/A (superseded by F1-197) | F1-214R1 | -- | N/A |
| F1-99 | <u>14</u> | 8 June 1964 | F1-215 | <u>116</u> | 8 August 1966 |
| F1-100 | <u>7</u> | 8 June 1964 | F1-215R1 | -- | N/A |
| F1-101 | 8 | 8 June 1964 | F1-215R2 | -- | N/A |
| F1-106 | 7 | 8 June 1964 | F1-216 | <u>31</u> | N/A |
| F1-108 | 7 | 8 June 1964 | F1-216R1 | -- | N/A |
| F1-124 | 7 | 8 June 1964 | F1-217 | 7 | N/A |
| F1-129 | 8 | N/A | F1-226 | <u>35</u> | N/A |
| F1-129R1 | -- | N/A | F1-228 | <u>36</u> | 27 October 1964 |
| F1-131 | 7 | N/A | F1-229 | <u>8</u> | 27 October 1964 |
| F1-132 | 7 | 8 June 1964 | F1-229R1 | -- | N/A |
| F1-135 | 7 | 8 June 1964 | F1-233 | <u>38</u> | 28 September 1964 |
| F1-143 | <u>11</u> | 8 June 1964 | F1-235 | <u>31</u> | N/A |
| F1-143R1 | -- | N/A | F1-236 | <u>7</u> | 27 October 1964 |
| F1-146 | 1 | 8 June 1964 | F1-241 | 7 | 27 October 1964 |
| F1-147 | 7 | 8 June 1964 | F1-242 | <u>39</u> | 27 October 1964 |
| F1-149 | <u>11</u> | 27 October 1964 | F1-244 | <u>7</u> | 27 October 1964 |
| F1-153 | <u>7</u> | N/A | F1-251 | 7 | 27 October 1964 |
| F1-154 | 7 | 8 June 1964 | F1-253 | <u>43</u> | N/A |
| F1-166 | <u>13</u> | 8 June 1964 | F1-254 | <u>7</u> | 27 October 1964 |
| F1-168 | <u>8</u> | 8 June 1964 | F1-255 | <u>42, 45</u> | N/A |
| F1-169 | 7 | 8 June 1964 | F1-258 | <u>22</u> | 27 October 1964 |
| F1-172 | 7 | 8 June 1964 | F1-258R1 | -- | N/A |
| | | | F1-258R2 | -- | N/A |
| | | | F1-260 | <u>54</u> | N/A |

Figure 4. Configuration Changes--Manual Effectivity (Sheet 1 of 4)

| Approved ECP No. | MD No. | Incorporated in Manual Dated | Approved ECP No. | MD No. | Incorporated in Manual Dated |
|------------------|-----------------|------------------------------|------------------|-----------------|------------------------------|
| F1-260R1 | -- | N/A | F1-313 | <u>69</u> | 28 September 1965 |
| F1-260R2 | <u>155</u> | N/A | F1-313R1 | -- | N/A |
| F1-261 | <u>22</u> | 17 May 1965 | F1-314 | <u>31</u> | 28 September 1965 |
| F1-262 | <u>50</u> | N/A | F1-315 | <u>70,83</u> | 28 September 1965 |
| F1-263 | <u>51</u> | N/A | F1-315R1 | -- | N/A |
| F1-267 | <u>49</u> | 17 May 1965 | F1-315R2 | -- | N/A |
| F1-268 | <u>59</u> | 17 May 1965 | F1-316 | <u>31</u> | 8 August 1966 |
| F1-268R1 | -- | N/A | F1-317 | <u>71</u> | 8 August 1966 |
| F1-269 | <u>55</u> | 17 May 1965 | F1-319 | <u>31</u> | N/A |
| F1-270 | <u>47</u> | 28 September 1965 | F1-320 | <u>75</u> | 8 August 1966 |
| F1-270R1 | -- | N/A | F1-320R1 | -- | N/A |
| F1-270R2 | -- | N/A | F1-321 | <u>31</u> | 28 September 1965 |
| F1-274 | <u>53</u> | N/A | F1-323 | <u>84,85,86</u> | N/A |
| F1-276 | <u>22</u> | N/A | F1-323R1 | -- | N/A |
| F1-277 | <u>61</u> | N/A | F1-323R2 | -- | N/A |
| F1-278 | <u>64</u> | N/A | F1-323R3 | -- | N/A |
| F1-279 | <u>21</u> | N/A | F1-324 | <u>72</u> | 28 September 1965 |
| F1-279R1 | -- | N/A | F1-324R1 | -- | N/A |
| F1-282 | <u>31</u> | 12 January 1966 | F1-326 | <u>79,80,95</u> | N/A |
| F1-283 | <u>65</u> | 14 October 1966 | F1-328 | <u>76</u> | 28 September 1965 |
| F1-283R1 | -- | N/A | F1-328R1 | -- | N/A |
| F1-283R2 | -- | N/A | F1-331 | <u>31</u> | 8 August 1966 |
| F1-285 | <u>68</u> | 28 September 1965 | F1-332 | <u>31</u> | N/A |
| F1-285R1 | -- | N/A | F1-333 | <u>54</u> | 8 August 1966 |
| F1-287 | <u>31</u> | 14 October 1966 | F1-335 | <u>31</u> | 31 March 1967 |
| F1-288 | <u>31</u> | 14 October 1966 | F1-342 | <u>30</u> | N/A |
| F1-289 | <u>63</u> | N/A | F1-343 | <u>90,91</u> | 31 March 1967 |
| F1-289R1 | -- | N/A | F1-347 | <u>31</u> | 31 March 1967 |
| F1-289R2 | -- | N/A | F1-352 | <u>31</u> | 12 January 1966 |
| F1-294 | <u>57</u> | 17 May 1965 | F1-352R1 | -- | N/A |
| F1-294R1 | -- | N/A | F1-353 | <u>82</u> | N/A |
| F1-294R2 | -- | N/A | F1-356 | <u>88,93</u> | 28 September 1965 |
| F1-303 | <u>54</u> | 8 August 1966 | F1-357 | <u>89</u> | 8 August 1966 |
| F1-303R1 | -- | N/A | F1-358 | <u>31</u> | 8 August 1966 |
| F1-304 | <u>67</u> | N/A | F1-360 | <u>99</u> | 8 August 1966 |
| F1-304R1 | -- | N/A | F1-361 | <u>92</u> | N/A |
| F1-305 | <u>73</u> | 28 September 1965 | F1-362 | <u>54</u> | 31 March 1967 |
| F1-305R1 | -- | N/A | F1-369 | <u>94</u> | 8 August 1966 |
| F1-306 | <u>66</u> | N/A | F1-370 | <u>106</u> | N/A |
| F1-306R1 | -- | N/A | F1-370R1 | -- | N/A |
| F1-306R2 | -- | N/A | F1-370R2 | -- | N/A |
| F1-307 | <u>74</u> | N/A | F1-370R3 | -- | N/A |
| F1-307R1 | -- | N/A | F1-370R4 | -- | N/A |
| F1-308 | <u>31</u> | N/A | F1-371 | <u>31</u> | 7 April 1966 |
| F1-309 | <u>77,80,95</u> | 8 August 1966 | F1-372 | <u>100</u> | 31 March 1967 |
| F1-310 | <u>78,80,95</u> | 8 August 1966 | F1-372R1 | -- | N/A |
| F1-311 | <u>31,108</u> | 28 September 1965 | F1-372R2 | -- | N/A |
| F1-311R1 | -- | N/A | F1-378 | <u>58</u> | N/A |
| F1-312 | <u>96,97</u> | 12 January 1966 | F1-378R1 | -- | N/A |
| F1-312R1 | -- | N/A | F1-378R2 | -- | N/A |
| F1-312R2 | -- | N/A | F1-378R3 | -- | N/A |
| F1-312R3 | -- | N/A | F1-379 | <u>101</u> | 12 January 1966 |
| F1-312R4 | <u>179</u> | N/A | F1-379R1 | -- | N/A |

Figure 4. Configuration Changes--Manual Effectivity (Sheet 2 of 4)

| Approved ECP No. | MD No. | Incorporated in Manual Dated | Approved ECP No. | MD No. | Incorporated in Manual Dated |
|------------------|-----------------|------------------------------|------------------|------------|------------------------------|
| F1-379R2 | -- | N/A | F1-436 | <u>123</u> | 8 August 1966 |
| F1-380 | <u>99</u> | 7 April 1966 | F1-437 | <u>115</u> | 14 October 1966 |
| F1-381 | <u>31</u> | N/A | F1-437R1 | -- | N/A |
| F1-391 | <u>102, 103</u> | 7 April 1966 | F1-437R2 | -- | N/A |
| F1-391R1 | -- | N/A | F1-437R3 | -- | N/A |
| F1-392 | <u>137</u> | 31 March 1967 | F1-438 | <u>131</u> | 31 March 1967 |
| F1-392R1 | -- | N/A | F1-439 | <u>146</u> | 10 August 1967 |
| F1-392R2 | -- | N/A | F1-439R1 | -- | N/A |
| F1-405 | <u>128</u> | 31 March 1967 | F1-441 | <u>140</u> | 10 August 1967 |
| F1-405R1 | -- | N/A | F1-441R1 | -- | N/A |
| F1-405R2 | -- | N/A | F1-441R2 | -- | N/A |
| F1-406 | -- | 31 March 1967 | F1-441R3 | -- | N/A |
| F1-407 | <u>109</u> | 31 March 1967 | F1-443 | <u>129</u> | 14 October 1966 |
| F1-407R1 | -- | N/A | F1-444 | <u>139</u> | 10 August 1967 |
| F1-408 | <u>104</u> | 7 April 1966 | F1-444R1 | -- | N/A |
| F1-408R1 | -- | 7 April 1966 | F1-444R2 | -- | N/A |
| F1-409 | <u>105</u> | 7 April 1966 | F1-445 | <u>122</u> | 8 August 1966 |
| F1-410 | <u>128</u> | 31 March 1967 | F1-445R1 | -- | N/A |
| F1-410R1 | -- | N/A | F1-447 | <u>138</u> | N/A |
| F1-415 | <u>107</u> | 8 August 1966 | F1-447R1 | -- | N/A |
| F1-416 | <u>120</u> | 31 March 1967 | F1-447R2 | -- | N/A |
| F1-416R1 | -- | N/A | F1-448 | <u>149</u> | 10 August 1967 |
| F1-417 | -- | N/A | F1-448R1 | -- | N/A |
| F1-418 | -- | 31 March 1967 | F1-448R2 | -- | N/A |
| F1-418R1 | -- | N/A | F1-449 | <u>127</u> | 31 March 1967 |
| F1-419 | -- | 31 March 1967 | F1-449R1 | -- | N/A |
| F1-419R1 | -- | N/A | F1-452 | <u>126</u> | 31 March 1967 |
| F1-420 | -- | 31 March 1967 | F1-452R1 | -- | N/A |
| F1-420R1 | -- | N/A | F1-453 | <u>123</u> | N/A |
| F1-421 | -- | N/A | F1-454 | <u>118</u> | 31 March 1967 |
| F1-421R1 | -- | N/A | F1-454R1 | -- | N/A |
| F1-421R2 | -- | N/A | F1-454R2 | -- | N/A |
| F1-422 | <u>113, 114</u> | 8 August 1966 | F1-456 | <u>124</u> | 8 August 1966 |
| F1-422R1 | -- | N/A | F1-456R1 | -- | N/A |
| F1-423 | <u>119</u> | N/A | F1-457 | <u>136</u> | N/A |
| F1-423R1 | -- | N/A | F1-459 | <u>130</u> | 31 March 1967 |
| F1-424 | <u>110</u> | 8 August 1966 | F1-464 | -- | 14 October 1966 |
| F1-424R1 | -- | N/A | F1-467 | -- | N/A |
| F1-426 | <u>117</u> | 8 August 1966 | F1-467R1 | -- | N/A |
| F1-426R1 | -- | N/A | F1-468 | <u>128</u> | 31 March 1967 |
| F1-427 | <u>111</u> | 31 March 1967 | F1-470 | <u>140</u> | 10 August 1967 |
| F1-427R1 | -- | N/A | F1-470R1 | -- | N/A |
| F1-427R2 | -- | N/A | F1-470R2 | -- | N/A |
| F1-428 | <u>87</u> | N/A | F1-471 | -- | N/A |
| F1-428R1 | -- | N/A | F1-475 | -- | N/A |
| F1-430 | <u>112</u> | 8 August 1966 | F1-475R1 | -- | N/A |
| F1-431 | <u>137</u> | 31 March 1967 | F1-475R2 | -- | N/A |
| F1-431R1 | -- | N/A | F1-476 | <u>135</u> | 31 March 1967 |
| F1-431R2 | -- | N/A | F1-476R1 | -- | N/A |
| F1-432 | <u>125</u> | 31 March 1967 | F1-478 | <u>137</u> | N/A |
| F1-432R1 | -- | N/A | F1-478R1 | -- | N/A |
| F1-432R2 | -- | N/A | F1-478R2 | -- | N/A |
| F1-434 | <u>121</u> | 31 March 1967 | F1-480 | <u>132</u> | 31 March 1967 |
| F1-434R1 | -- | N/A | | | |

Figure 4. Configuration Changes--Manual Effectivity (Sheet 3 of 4)

| Approved ECP No. | MD No. | Incorporated in Manual Dated | Approved ECP No. | MD No. | Incorporated in Manual Dated |
|---------------------|----------------------|---------------------------------|---------------------|----------------------|---------------------------------|
| F1-480R1 | -- | N/A | F1-535 | -- | N/A |
| F1-482 | <u>133, 134, 142</u> | 31 March 1967 | F1-543 | <u>165</u> | 11 March 1968 |
| F1-482R1 | <u>142</u> | 10 August 1967 | F1-543R1 | -- | N/A |
| F1-495 | <u>144</u> | 10 August 1967 | F1-545 | <u>154</u> | 11 March 1968 |
| F1-495R1 | -- | N/A | F1-547 | <u>169</u> | N/A |
| F1-498 | <u>145</u> | 10 August 1967 | F1-548 | <u>160</u> | 13 February 1968 |
| F1-498R1 | -- | N/A | F1-548R1 | -- | N/A |
| F1-498R2 | -- | N/A | F1-552 | <u>170</u> | 14 July 1968 |
| F1-499 | <u>137</u> | 10 August 1967 | F1-552R1 | -- | N/A |
| F1-499R1 | -- | N/A | F1-552R2 | -- | N/A |
| F1-500 | <u>150, 151</u> | 10 August 1967 | F1-579 | -- | 11 March 1968 |
| F1-500R1 | -- | N/A | F1-580 | -- | N/A |
| F1-502 | <u>148</u> | N/A | F1-581 | <u>167, 168</u> | 14 July 1968 |
| F1-504 | <u>141</u> | 31 March 1967 | F1-581R1 | -- | N/A |
| F1-504R1 | <u>141</u> | 10 August 1967 | F1-581R2 | -- | N/A |
| F1-505 | <u>161</u> | N/A | F1-581R3 | -- | N/A |
| F1-505R1 | -- | N/A | F1-581R4 | -- | N/A |
| F1-505R2 | -- | N/A | F1-586 | -- | N/A |
| F1-506 | <u>159</u> | 13 February 1968 | F1-587 | -- | N/A |
| F1-507 | -- | N/A | F1-590 | <u>176</u> | 18 August 1969 |
| F1-509 | <u>143</u> | N/A | F1-590R1 | -- | N/A |
| F1-510 | <u>152</u> | 10 August 1967 | F1-590R2 | -- | N/A |
| F1-510R1 | -- | N/A | F1-590R3 | -- | N/A |
| F1-511 | <u>146</u> | 10 August 1967 | F1-590R4 | -- | N/A |
| F1-511R1 | -- | N/A | F1-591 | <u>172</u> | N/A |
| F1-512 | <u>177</u> | 10 August 1967 | F1-592 | <u>173</u> | 18 August 1969 |
| F1-512R1 | -- | N/A | F1-592R1 | -- | N/A |
| F1-515 | <u>147</u> | 14 July 1968 | F1-594 | -- | N/A |
| F1-515R1 | -- | N/A | F1-594R1 | -- | N/A |
| F1-521 | <u>154</u> | 13 February 1968 | F1-596 | <u>174</u> | N/A |
| F1-521R1 | -- | N/A | F1-596R1 | -- | N/A |
| F1-521R2 | <u>154</u> | 11 March 1968 | F1-597 | <u>175</u> | N/A |
| F1-521R3 | -- | N/A | F1-601 | -- | N/A |
| F1-521R4 | <u>183</u> | N/A | F1-602 | <u>178</u> | N/A |
| F1-522 | -- | N/A | F1-604 | <u>180</u> | 4 November 1970 |
| F1-523 | -- | 13 February 1968 | F1-607 | <u>181</u> | 4 November 1970 |
| F1-524 | -- | 13 February 1968 | F1-607R1 | -- | N/A |
| F1-525 | <u>157, 158</u> | 13 February 1968 | F1-607R2 | -- | N/A |
| F1-525R1 | -- | N/A | F1-607R3 | -- | N/A |
| F1-526 | <u>156</u> | 14 July 1968 | F1-612 | <u>184, 185</u> | 4 November 1970 |
| F1-526R1 | -- | N/A | F1-612R1 | -- | N/A |
| F1-530 | <u>162, 163</u> | 13 February 1968 | F1-612R2 | -- | N/A |
| F1-530R1 | -- | N/A | F1-613 | <u>186, 187</u> | 4 November 1970 |
| F1-530R2 | -- | N/A | F1-617 | -- | N/A |
| F1-530R3 | -- | N/A | F1-618 | <u>188, 189, 190</u> | N/A |
| | | | F1-618R1 | -- | N/A |

Figure 4. Configuration Changes--Manual Effectivity (Sheet 4 of 4)

SECTION I
ENGINE DESCRIPTION

SECTION I

DESCRIPTION AND OPERATION

1-1. **SCOPE.** This section contains a general description of the F-1 propulsion system and a detailed description of each subsystem and component. Engine operation from the preparation phase through and including the engine cutoff phase is defined. Also included, are external inputs necessary for engine operation, typical engine operating parameters, and a description of the flow the engine follows from the time it is accepted by the Customer through Apollo/Saturn V launch.

1-2. F-1 ROCKET ENGINE.

1-3. The F-1 propulsion system was developed to provide the power for the booster flight phase of the Saturn V vehicle. Five engines are clustered in the S-IC stage of the Saturn V to obtain the necessary 7,610,000 pounds thrust.

1-4. The engine features a two-piece thrust chamber that is tubular-walled and regeneratively cooled to the 10:1 expansion ratio plane, and double-walled and turbine gas cooled to the 16:1 expansion ratio plane; a thrust chamber mounted turbopump that has two centrifugal pumps spline-connected on a single shaft driven by a two-stage, direct-driven turbine; one-piece rigid propellant ducts that are used in pairs to direct the fuel and oxidizer to the thrust chamber; and a hypergolic fluid cartridge that is used for thrust chamber ignition.

1-5. The engine is within an envelope of approximately 12.5 feet in diameter and 19.2 feet long and weighs approximately 18,600 pounds dry. Refer to section II for specific dimensions and weight. Thrust vector changes are achieved by gimbaling the entire engine. The gimbal block is located on the thrust chamber dome, and actuator attach points are provided by two outriggers on the thrust chamber body.

1-6. Component locations on the engine in the horizontal position are basically referenced to No. 1 (left) (figure 1-1) or No. 2 (right) (figure 1-2) sides of the engine as viewed from the exit end of the thrust chamber with the turbopump at 12 o'clock (top) and the hypergol manifold assembly at 6 o'clock (bottom). Component locations on the engine in the vertical position are referenced to the principal component on the four sides of the engine (eg, gas generator side (No. 1), engine control valve side (No. 2),

turbopump side, and hypergol manifold side). A view of the forward end of the engine is shown in figure 1-3.

1-7. ENGINE PHYSICAL DESCRIPTION.

1-8. The F-1 engine is a single-start, fixed-thrust, liquid bipropellant engine, calibrated to develop a sea-level-rated thrust of 1,522,000 pounds with a specific impulse (I_{sp}) of 265.3 seconds. Engine propellants are liquid oxygen and propellant kerosene fuel at a mixture ratio of 2.27:1. The propellant kerosene fuel is used as the working fluid for the gimbal actuators and for the engine control system and is also used as the turbopump bearing lubricant. The F-1 engine is comprised of seven operational systems:

(1) A propellant feed system, which supplies pressurized propellants for combustion and hydraulic pressure for the engine control system.

(2) An ignition system, which initiates combustion in the gas generator and the thrust chamber.

(3) A gas generating system, which produces the energy to drive the turbopump and condition propellant tank pressurants.

(4) An engine control system, which regulates the start, operating level, and shutdown of the engine.

(5) A flight instrumentation system, which measures selected engine parameters for monitoring and evaluating the operational characteristics of the engine.

(6) An environmental conditioning system, which protects the engine from extreme temperature environment caused by plume radiation and backflow during flight.

(7) A purge and drain system, which inhibits contamination and facilitates the overboard disposition of expended fluids. Detailed information of the engine system and its components is in the following paragraphs. An engine fluid schematic (figure 1-4), engine leading particulars (figure 1-5), and an engine performance schematic (figure 1-5A) are included to support the text. Detailed information on engine operation is presented in paragraphs 1-121 through 1-133.

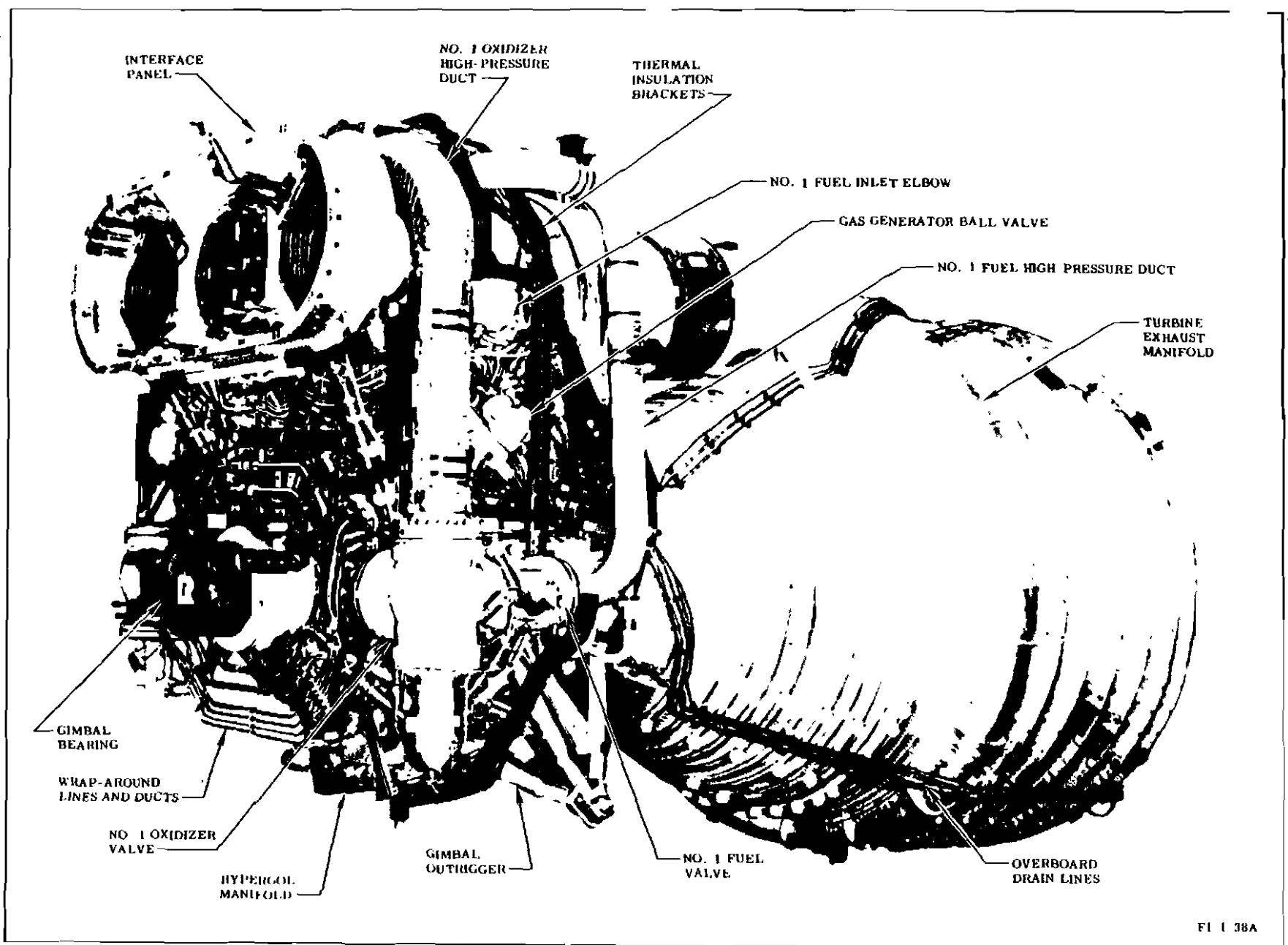
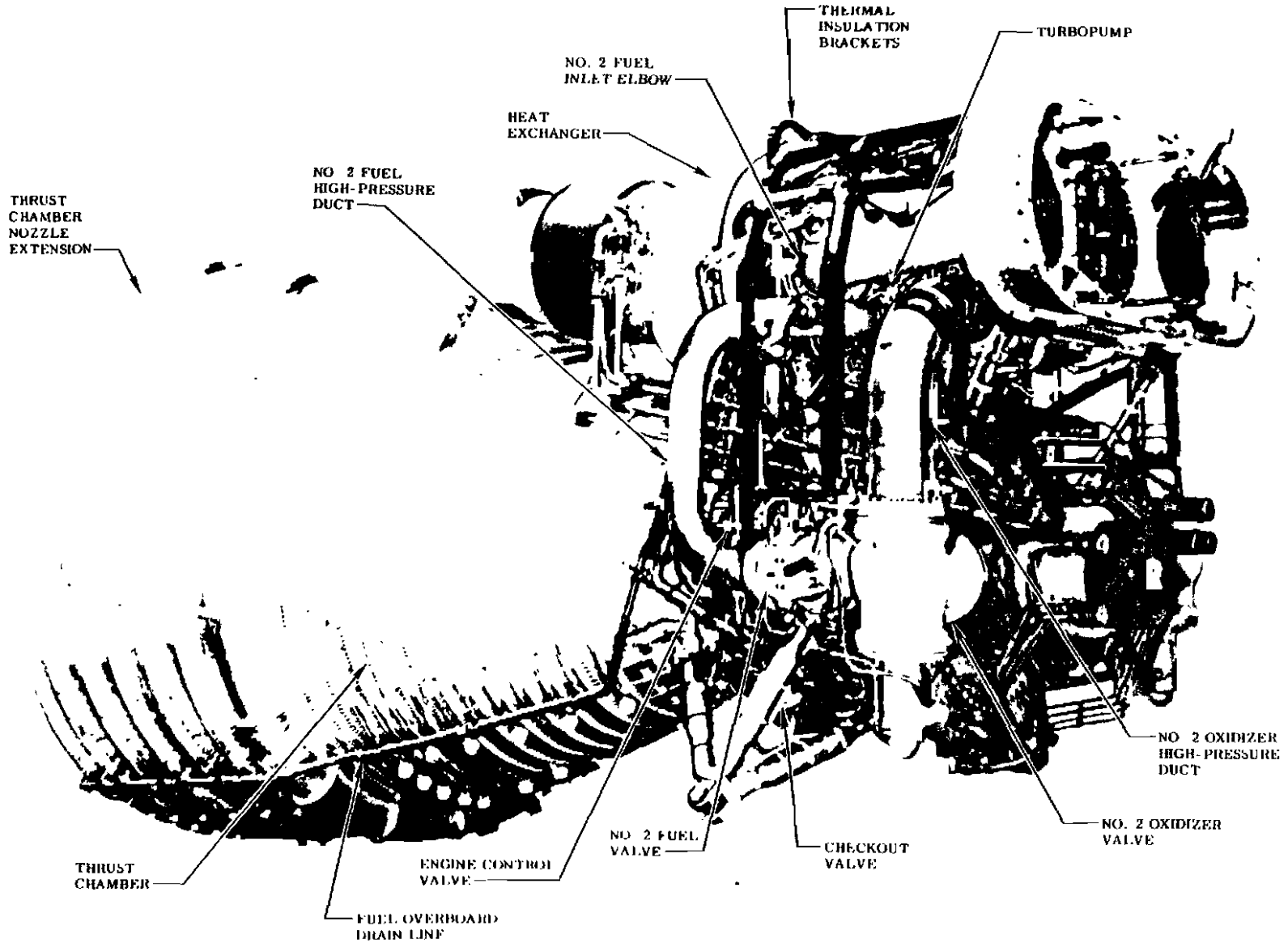

Figure 1-1. F-1 Rocket Engine, Number One Side



F1-1-39A

Figure 1-2. F-1 Rocket Engine, Number Two Side

Change No. 9 - 4 November 1970

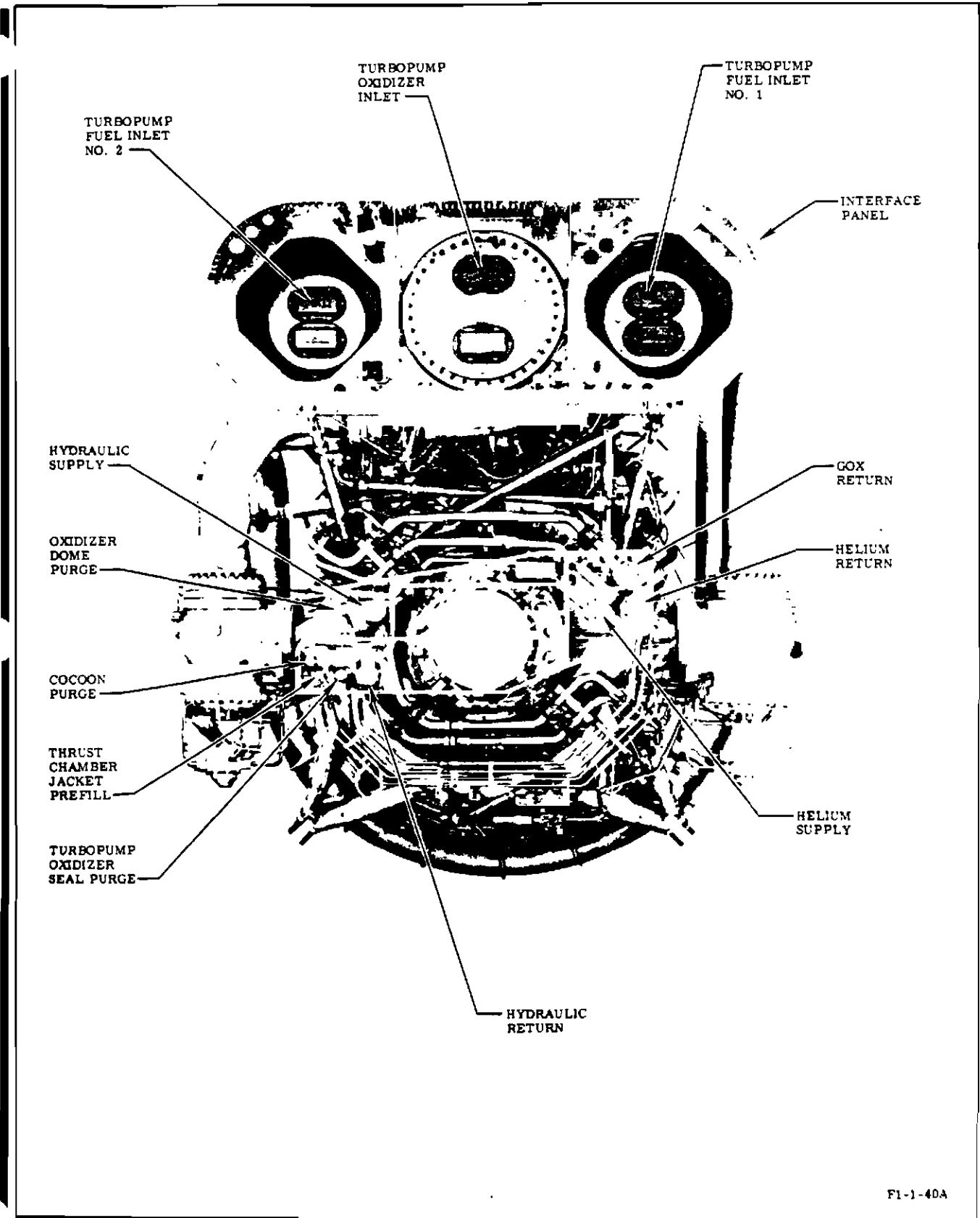

Figure 1-3. F-1 Rocket Engine, Forward End

| | | | |
|--|------------------------------|---|-----------------------------|
| Thrust level (sea level) | 1,522,000 lb | Gas generator mixture ratio | 0.416:1 |
| Specific impulse (sea level) | 265.3 sec | Gas generator combustor pressure | 980 psia |
| Total propellant flowrate | 5,737 lb/sec (40,670 gpm) | Gas generator temperature | 1,453° F |
| Fuel | 1,758 lb/sec (15,632 gpm) | Turbine speed | 5,492 rpm |
| Oxidizer | 3,981 lb/sec (25,038 gpm) | Time from turbopump initiation to rated speed | 5.2 sec |
| | | Time from cutoff to zero rpm | 3.5 sec |
| Mixture ratio | 2.27:1 | Turbine brake horsepower | 53,146 hp |
| Expansion ratio | 16:1 | Nozzle extension coolant gas temperature | 1,138° F |
| Thrust chamber pressure | 1,125 psia | Hydraulic recirculation flowrate | 11.6 ±1.1 gpm at 1,500 psig |
| Thrust chamber temperature | 5,970° F | Engine dry weight (average) | 18,619 lb |
| Thrust chamber exit pressure (16:1) | 9.6 psia | | |
| Fuel pump discharge pressure | 1,870 psia | | |
| Oxidizer pump discharge pressure | 1,602 psia | | |
| Gas generator flowrate (included in total) | 167 lb/sec | | |
| Fuel | 118 lb/sec | | |
| Oxidizer | 49 lb/sec | | |

Figure 1-5. Engine Leading Particulars (Engines Incorporating MD128 or MD174 Change)

Change No. 10 - 16 July 1971
1-6A

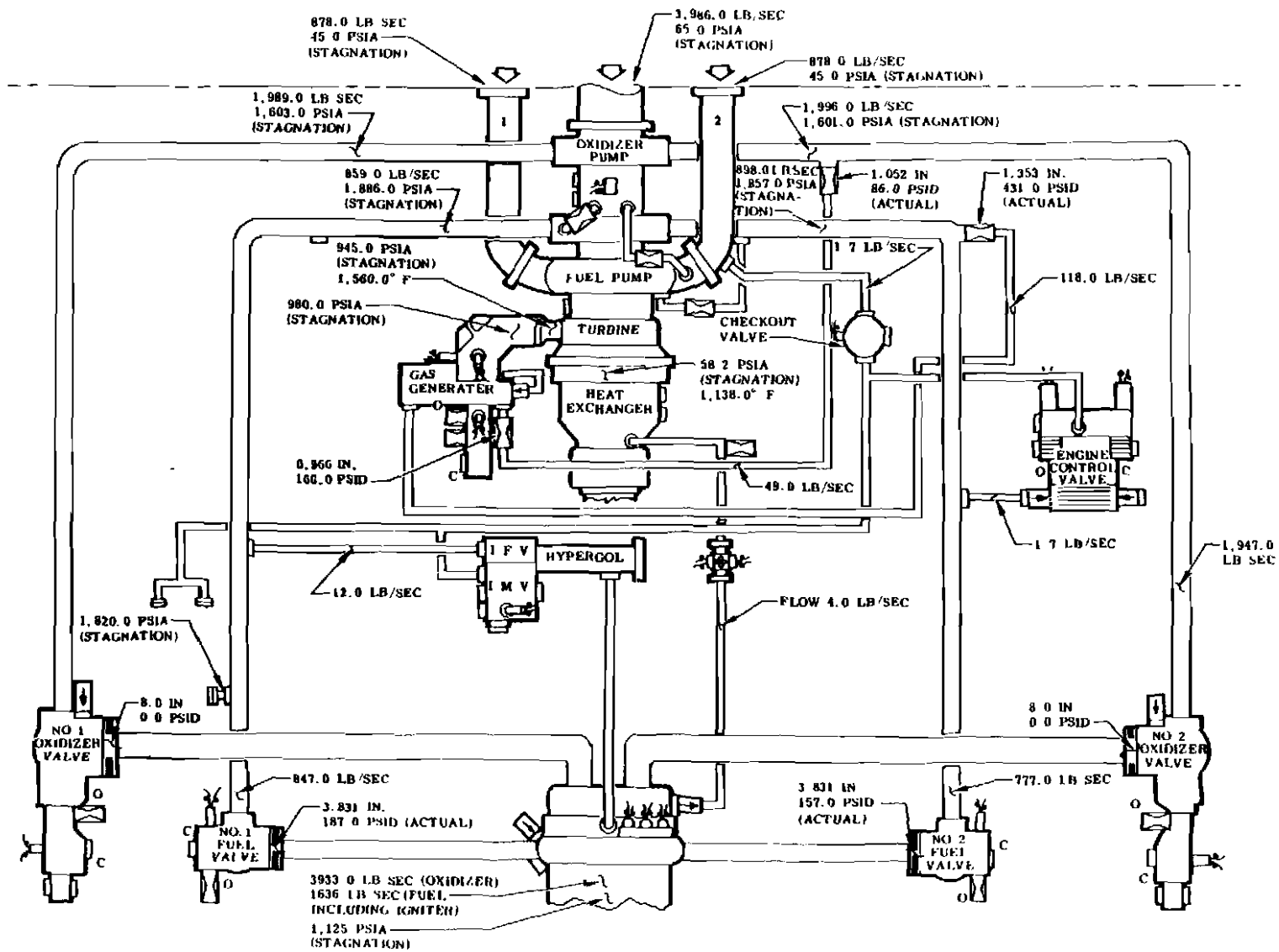

Figure 1-5A. Engine Performance Schematic (Engines Incorporating MD128 or MD174 Change)

FL 1 122

R-3896-1

Section 1

1-9. PROPELLANT FEED SYSTEM
DESCRIPTION.

1-10. The propellant feed system transfers oxidizer and fuel, under pressure, from the propellant tanks to the thrust chamber and gas generator. The system consists of the following major components: A thrust chamber, a turbopump, two oxidizer valves, two fuel valves, two high-pressure oxidizer ducts, two high-pressure fuel ducts, and two fuel inlet elbows.

1-11. THRUST CHAMBER ASSEMBLY
DESCRIPTION.

1-12. The thrust chamber assembly (figure 1-6) is the engine section within which the engine thrust is developed and by which this thrust is transmitted to the thrust structure of the booster stage or test stand. The thrust is developed through the process of burning propellants in the combustion chamber and accelerating, to supersonic velocity, the gaseous products of this combustion through an expansion nozzle. The thrust is transmitted through a gimbal bearing and two gimbal actuator outrigger assemblies.

1-13. The thrust chamber assembly consists of a two-piece thrust chamber, an injector, an oxidizer dome and manifold, and a gimbal assembly. The gimbal assembly attaches to the oxidizer dome by eight bolts. The oxidizer dome is bolted to the injector by 16 inner-dome support bolts, and both the oxidizer dome and injector are bolted to the thrust chamber body by 64 outer-dome attach bolts. The dome, injector, and thrust chamber body are indexed to each other by one diamond-shaped and one round, noninterchangeable index pin, spaced 180 degrees apart at the interface flanges below the two oxidizer dome inlets. The mating flanges of the dome and injector are sealed by a Teflon-filled Flexitallic gasket. The mating flanges of the injector and thrust chamber body are sealed at the outer diameter by a Viton-A O-ring and at the inner diameter by a hollow Inconel-X O-ring. The Inconel-X O-ring incorporates drilled holes in its outer diameter to permit injector manifold fuel pressure to enter the hollow section to increase its sealing capability. Thrust chamber leading particulars are presented in figure 1-7. Thrust chamber and nozzle extension are illustrated in figure 1-8.

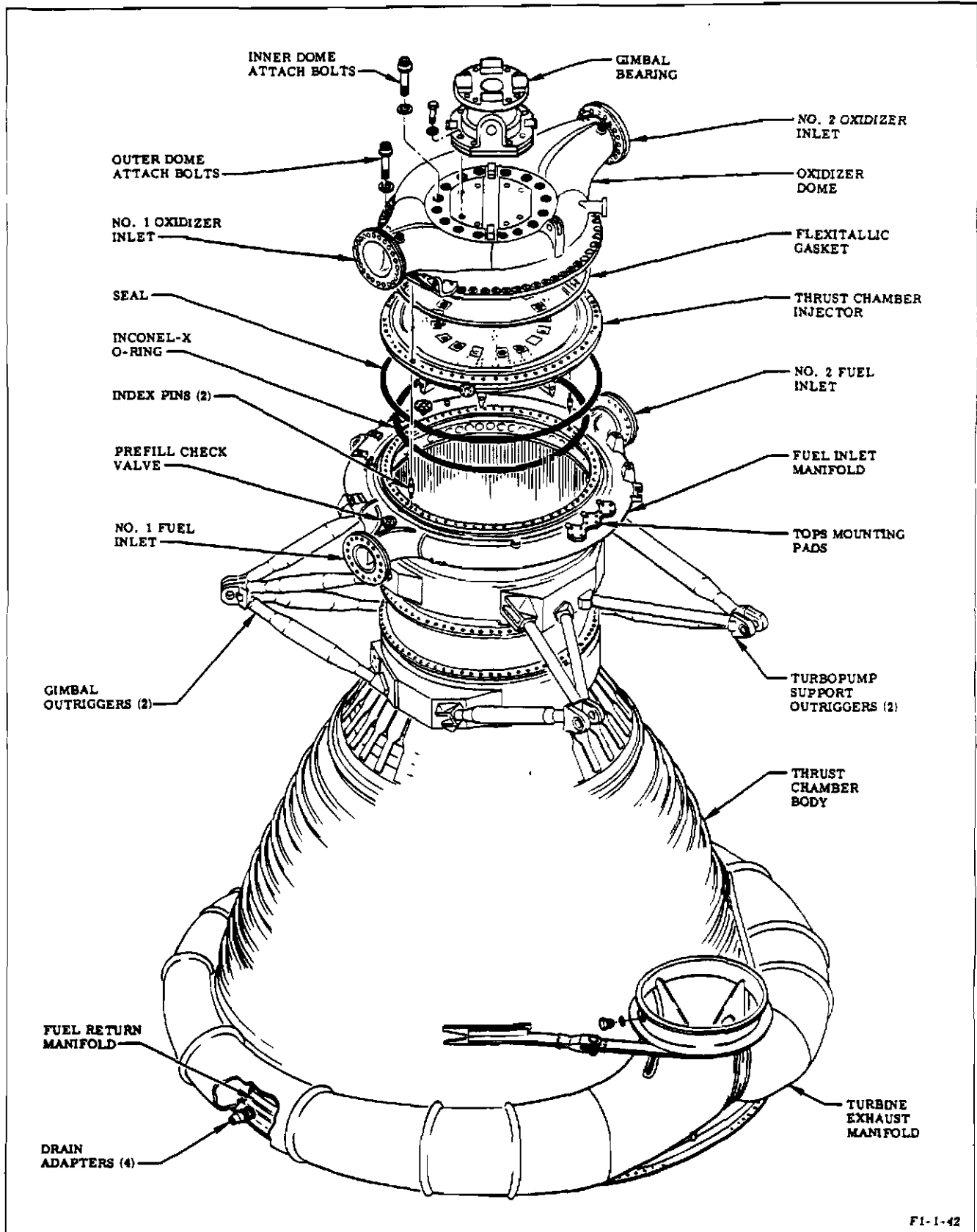

F1-1-42

Figure 1-6. Thrust Chamber Assembly

Change No. 7 - 18 August 1969

1-7

| | | | |
|--|--------------|-------------------------------------|-----------------|
| Thrust level (sea level) | 1,522,000 lb | Oxidizer dome pressure | 57 psia |
| Mixture ratio | 2.40:1 | drop | |
| | | Fuel jacket pressure drop | 244 psia |
| Propellant flowrates | | Valves pressure drops | |
| Oxidizer | 3,933 lb/sec | Oxidizer | 91 psia |
| Fuel | 1,636 lb/sec | Fuel | 210 psia |
| Injector end pressure | 1,125 psia | Expansion ratios | |
| Fuel injector manifold pressure | 1,222 psia | Thrust chamber | 10:1 |
| Exit pressure (16:1) | 9.6 psia | Thrust chamber and nozzle extension | 16:1 |
| Combustion area temperature | 5,970° F | | |
| Nozzle extension coolant gas temperature | 1,138° F | Fuel jacket prefill | |
| Fuel inlet manifold pressure | 1,466 psia | Solution | Ethylene glycol |
| | | Capacity | 103-105 gal. |
| Injector pressure drops | | | |
| Oxidizer | 309 psia | | |
| Fuel | 97 psia | | |

Figure 1-7. Thrust Chamber Leading Particulars (Engines Incorporating MD128 or MD174 Change)

1-14. THRUST CHAMBER BODY DESCRIPTION. The thrust chamber body contains a combustion chamber for the burning of the propellants, and a nozzle of the required 10:1 expansion ratio for expelling gases produced by the burned propellants at the supersonic velocity necessary to produce the desired thrust.

1-15. The thrust chamber body is a furnace-brazed, tubular-walled, regeneratively fuel-cooled, bell-shaped chamber incorporating two outrigger arms to support the turbopump and two outrigger arms to which the gimbal actuators attach. A fuel inlet manifold and a turbine exhaust manifold are welded to opposite ends of the chamber. One hundred seventy-eight primary tubes, hydraulically formed from 1-3/32 inch outside diameter Inconel-X tubing, make up the chamber body above the 3:1 expansion ratio plane (approximately 30 inches below the throat centerline plane). Three hundred fifty-six one-inch-outside-diameter secondary tubes of the same material form the chamber from the 3:1 to the 10:1 expansion ratio plane. A raised weld bead with the tube number and a directional flow arrow, identify fuel-up tube No. 1 and fuel-down tubes No. 60 and 120 on the chamber internal faces of the injector end ring

and fuel return manifold. External to the chamber the same tubes are similarly identified on reinforcing bands and straps below the thrust chamber throat.

1-16. Two secondary tubes are brazed to each primary tube at the 3:1 expansion ratio area plane. Every other primary tube is a fuel-down tube and is slotted on its outboard side at the fuel inlet manifold area into which fuel from the inlet manifold is directed. An orificed plug is brazed into the tube above the slot to permit 30 percent of the fuel to go directly to the fuel injector manifold. The remaining 70 percent of the fuel is used for regeneratively cooling the thrust chamber and is directed down the tube to the fuel return manifold at the end of the chamber. From the fuel return manifold, the fuel is directed by the adjacent fuel return tubes to the fuel injector manifold. The return manifold is welded to the bottom of the thrust chamber secondary tubes and incorporates four drain ports, located 90 degrees apart, to drain residual fluids. Forty lugs are welded to the inside wall of the return manifold for attaching the turbine exhaust leak-test fixture.

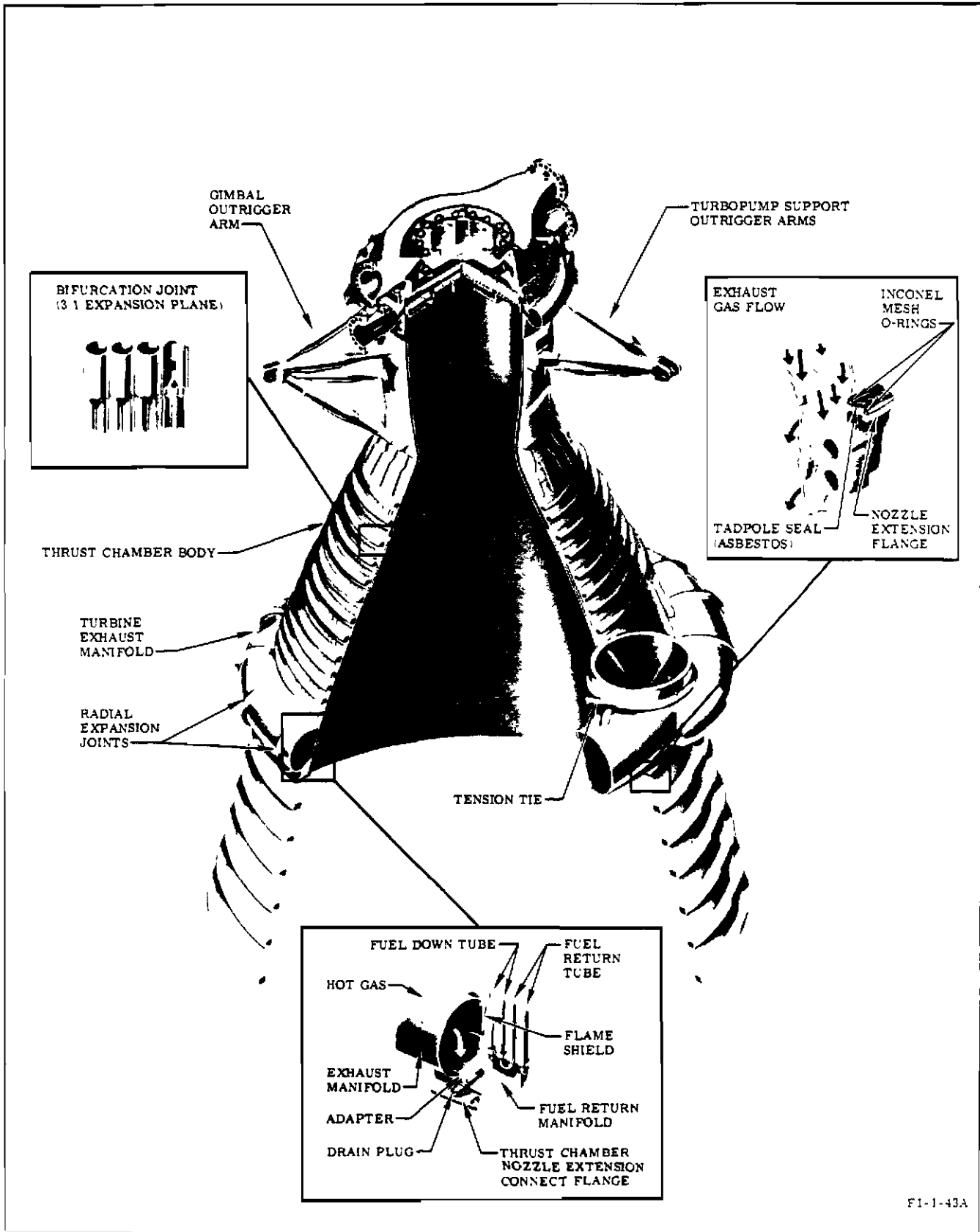

F1-1-43A

Figure 1-8. Thrust Chamber and Nozzle Extension

1-17. The fuel inlet manifold, welded to the upper end of the chamber body, incorporates two flanges, 180 degrees apart, for mounting the main fuel valves. A three-section flange for mounting the thrust OK pressure switches, and another for attaching the prefill check valve, are located on the inlet manifold. The fuel inlet manifold distributes fuel from the main fuel valves to the thrust chamber fuel-down tubes through angled, radial passages drilled through the inner wall of the manifold and aligned with slots in the primary fuel-down tubes.

1-18. The turbine exhaust manifold collects and evenly distributes the turbine exhaust gas to the area between the walls of the nozzle extension. The exhaust manifold is a CRES torus of decreasing (from inlet to exit) cross-sectional area incorporating 15 omega expansion joints to compensate for thermal growth. Splitter plates at the inlet and flow vanes at the exit area contribute to the uniform distribution of the exhaust gases into the nozzle extension. The exhaust manifold is welded to a flame shield that is welded to the outer wall of the thrust chamber.

1-19. THRUST CHAMBER INJECTOR DESCRIPTION. The thrust chamber injector distributes the propellants into the combustion chamber at the proper mixture ratio, pressure, and spray pattern to initiate and sustain stable combustion. It is a CRES, 31-ring, plate-type injector, divided into 13 compartments by 2 circular and 12 radial baffles, which dampen tangential and transverse combustion instability shock waves generated during combustion. The compartments are identified numerically, 1 through 13, and the baffles alphabetically, A through N. (See figure 1-9.) The 31-ring grooves consist of 16 fuel ring grooves alternating with 15 oxidizer ring grooves. The fuel ring grooves are supplied with fuel from the injector manifold by 32 radial passages, and the oxidizer ring grooves are supplied with oxidizer from the oxidizer dome by axially drilled holes. Fourteen copper rings, orifice-drilled to provide a doublet fuel-on-fuel impingement, and 2 circular, fuel-cooled copper baffles are brazed to the fuel ring grooves. Fifteen copper

rings, orificed-drilled to provide a doublet oxidizer-on-oxidizer impingement, are brazed to the oxidizer ring grooves. The twelve radial, fuel-cooled, copper baffles are supplied with fuel by the outer circular baffle to which they are brazed. Two igniter fuel housings in each of the 12 outer compartments and one igniter fuel housing in the center compartment, connected by individual fuel feed tubes to the igniter manifold, inject igniter fuel to the compartments. The center of compartment No. 13 is threaded for the attachment of the throat plug shaft.

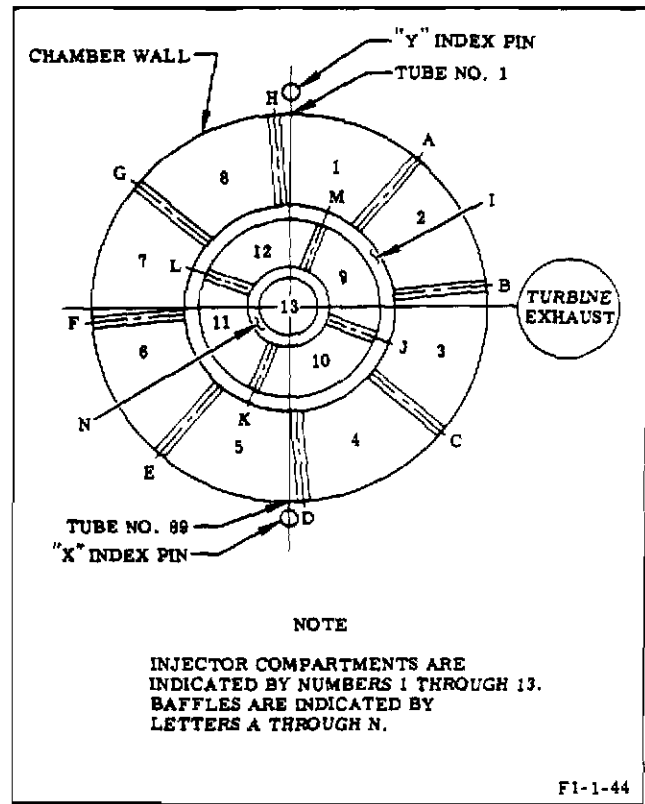

Figure 1-9. Thrust Chamber Injector
Compartments and Baffles

1-20. **THRUST CHAMBER OXIDIZER DOME AND MANIFOLD DESCRIPTION.** The thrust chamber oxidizer dome and manifold assembly (figure 1-10) distributes oxidizer to the thrust chamber injector and provides the attach point for the gimbal assembly. The assembly is a welded, CRES and nickel-base alloy unit consisting of a dome body and a torus manifold. The dome body contains the attaching flange and support posts for interfacing with the injector, and a slotted and drilled mounting flange for interfacing with the gimbal assembly. The manifold incorporates two inlets 180 degrees apart, for mounting the No. 1 and No. 2 oxidizer valves, and a flanged boss for the heat exchanger oxidizer supply line. To prevent vortexing of the oxidizer, the manifold is isolated into two compartments by two torus dams welded at 90 degrees from the inlets.

1-21. **GIMBAL BEARING ASSEMBLY DESCRIPTION.** The gimbal bearing assembly (figure 1-11) permits the engine assembly to be rotated about its x- and z-axes and thereby provides limited control of the engine thrust vector to enable the vehicle's guidance system to perform vehicle pitch, yaw, and roll commands. The gimbal bearing assembly is also the principal thrust interface between the engine and vehicle or test stand. The assembly is a spherical, low-friction, steel universal joint, incorporating ball- and socket-type bearing surfaces. A composition of Teflon-impregnated Fiberglass (Fabroid) is bonded to the bearing surfaces of the sockets. The main components of the gimbal assembly consist of a misalignment plate, a seat, a body, a block, and a shaft. A silicone-impregnated Fiberglass boot around the gimbal bearing protects the assembly from adverse environmental conditions.

1-22. The misalignment plate is the interface between the oxidizer dome and gimbal assembly and incorporates guides and threaded-type adjustment devices to laterally position the

assembly. Eight slotted holes in the plate flange, which coincide with eight threaded inserts in the dome flange, allow lateral adjustment of the plate along the x-axis. Eight oversized holes in the seat flange, coinciding with the slotted holes in the plate, allow lateral adjustment of the seat along the z-axis. The bottom guide recesses into a guide slot machined into the dome. The seat rests on the misalignment plate and has a guide slot into which the upper guide of the misalignment plate recesses. The seat contains the Fabroid-lined socket section within which the ball sections of the body move and incorporates two arms that support the shaft. The body is the engine interface to the vehicle or test stand structure. The body incorporates the ball section for the seat socket and the Fabroid-lined socket section for the ball section of the block. The block contains the ball section for the Fabroid-lined socket section of the body. The sides of the block are lined with Fabroid as are the surfaces of the hole into which the shaft fits. The shaft, through the support arms of the seat, transmits all bearing loads between the engine and vehicle. The shaft is prevented from rotating and moving axially by two plug and screw retainers. The Fabroid liners of the gimbal assembly are lubricated at assembly and require no further lubrication.

1-23. **THRUST CHAMBER NOZZLE EXTENSION DESCRIPTION.** The nozzle extension (figure 1-12) increases the thrust chamber expansion ratio to the ratio that provides an optimum average of engine performance over the powered phase of the booster stage trajectory. The nozzle extension is of welded construction, incorporating nickel-base-alloy inner and outer walls, separated by z-sections with CRES reinforcing channel bands welded to the outer wall circumference. Film cooling of the inner walls is achieved by injecting turbine exhaust gas, supplied to the cavity between the walls by the turbine exhaust manifold, into the thrust chamber exhaust stream through injector slots formed by 23 rows of overlapping shingles that form the inner wall. The thrust chamber nozzle extension is bolted to the thrust chamber exit-end ring after the engine is installed in the vehicle.

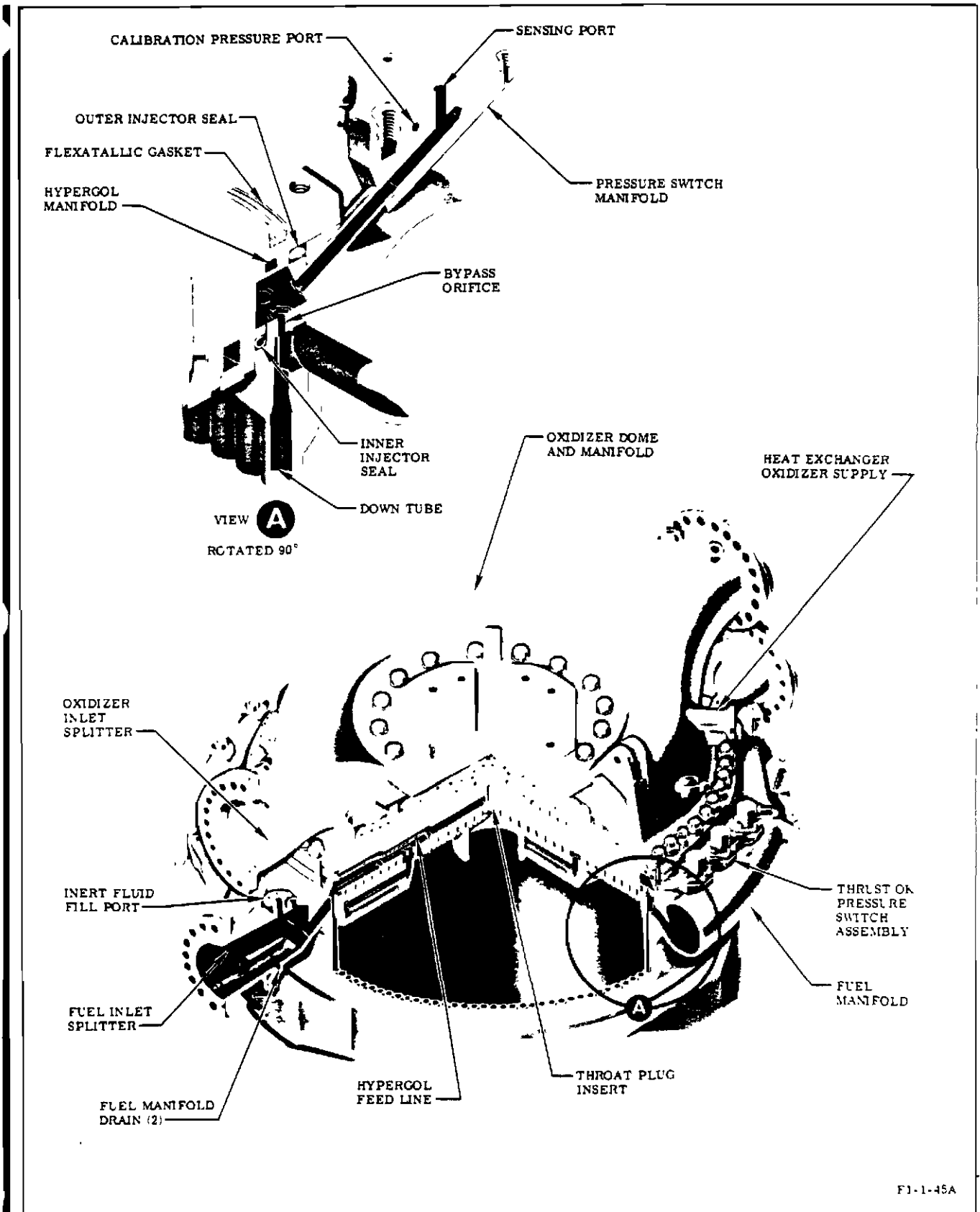

F1-1-45A

Figure 1-10. Thrust Chamber Oxidizer Dome

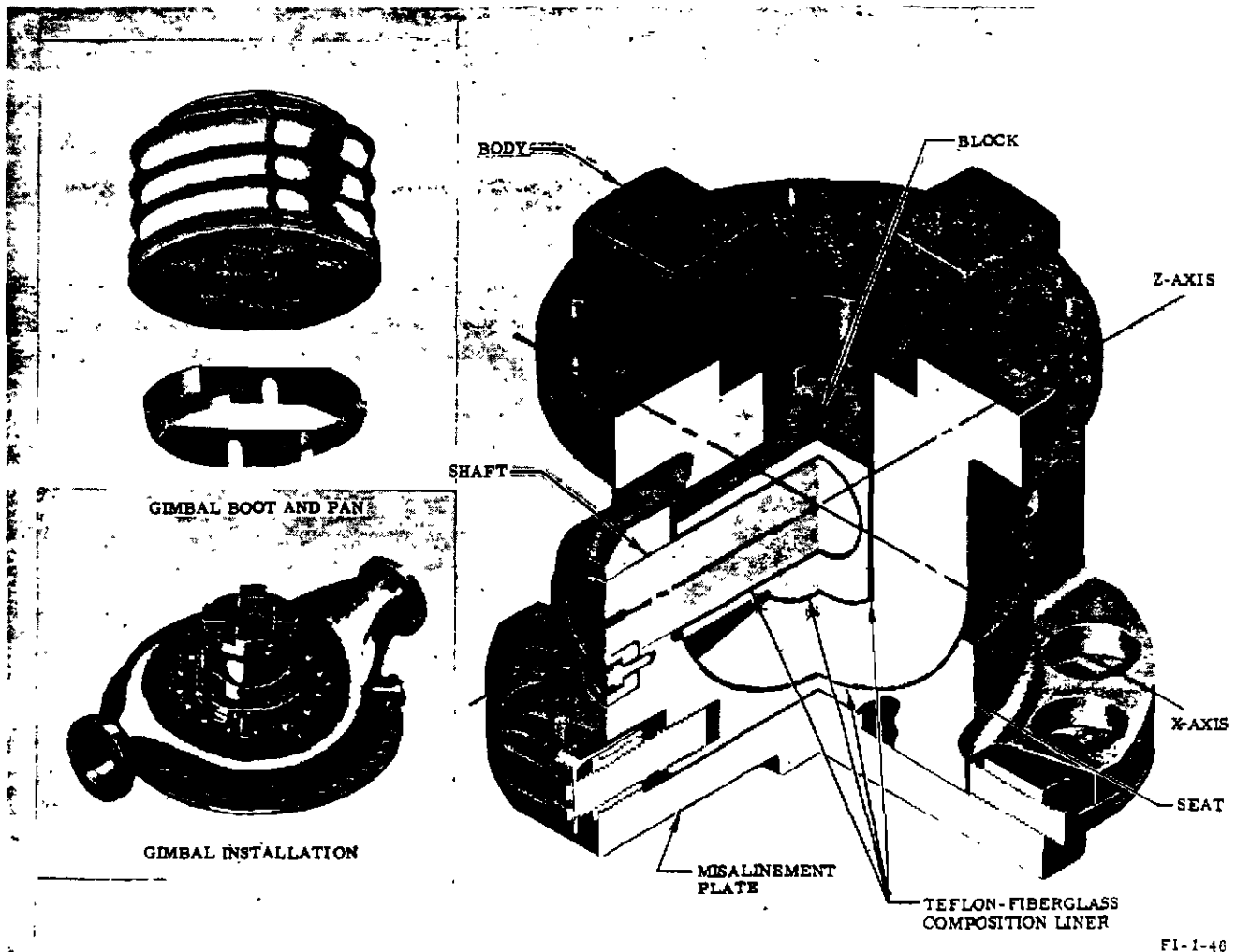

Figure 1-11. Gimbal Bearing

1-24. TURBOPUMP DESCRIPTION.

1-25. The turbopump assembly, designated the MK-10 turbopump, delivers propellants to the engine system at rated pressures and flowrates. The assembly is mounted parallel to the thrust chamber longitudinal centerline and is primarily supported by two three-legged outrigger assemblies welded to the chamber body and by the four high-pressure propellant ducts installed between the turbopump and the thrust chamber. The turbopump assembly (figures 1-13 and 1-14) is comprised of two centrifugal pumps, mounted back-to-back on a common shaft, directly driven by a two-stage, velocity compounded, impulse gas turbine. The main shaft and the rotating parts that attach directly

to the shaft are dynamically balanced as an assembly prior to final assembly of the turbopump assembly. Plugs in the fuel impeller and weights in the turbine wheels are installed, as required during the procedures, to achieve the required balance. Dual discharge ports on each of the pumps balance the radial loads on the assembly. The shaft is supported by two electrically heated, fuel-cooled ball bearing assemblies at the oxidizer pump area, and one fuel-cooled roller bearing assembly at the turbine area. (See figure 1-15 for a cutaway view of the turbopump.) Six carbon-nose and three carbon-segmented seals, augmented by plastic (Kel-F, Teflon) and synthetic rubber (Buna-N, Viton-A) seals, perform sealing functions to isolate the propellants, cooling fluid, and hot gases to their respective areas.

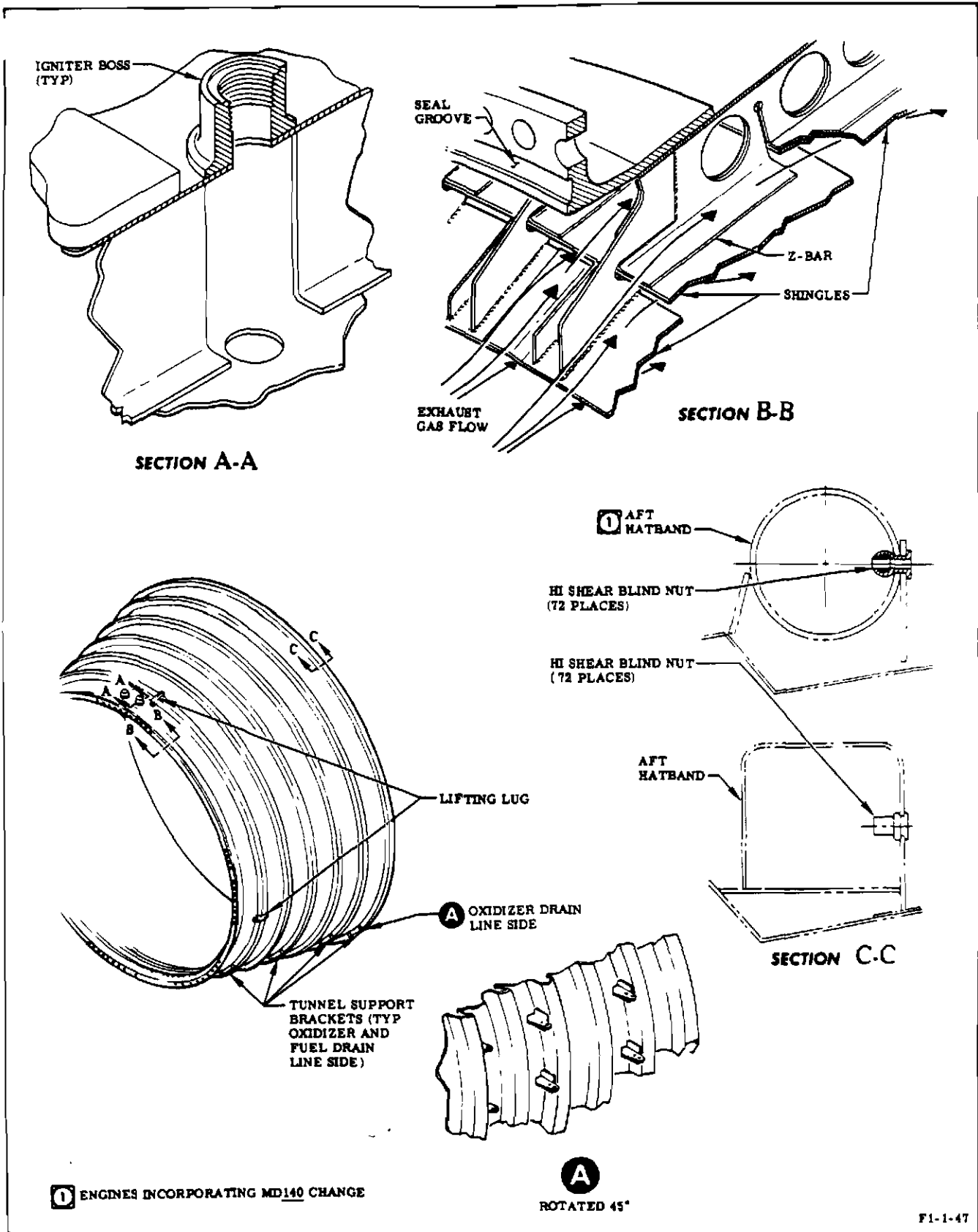
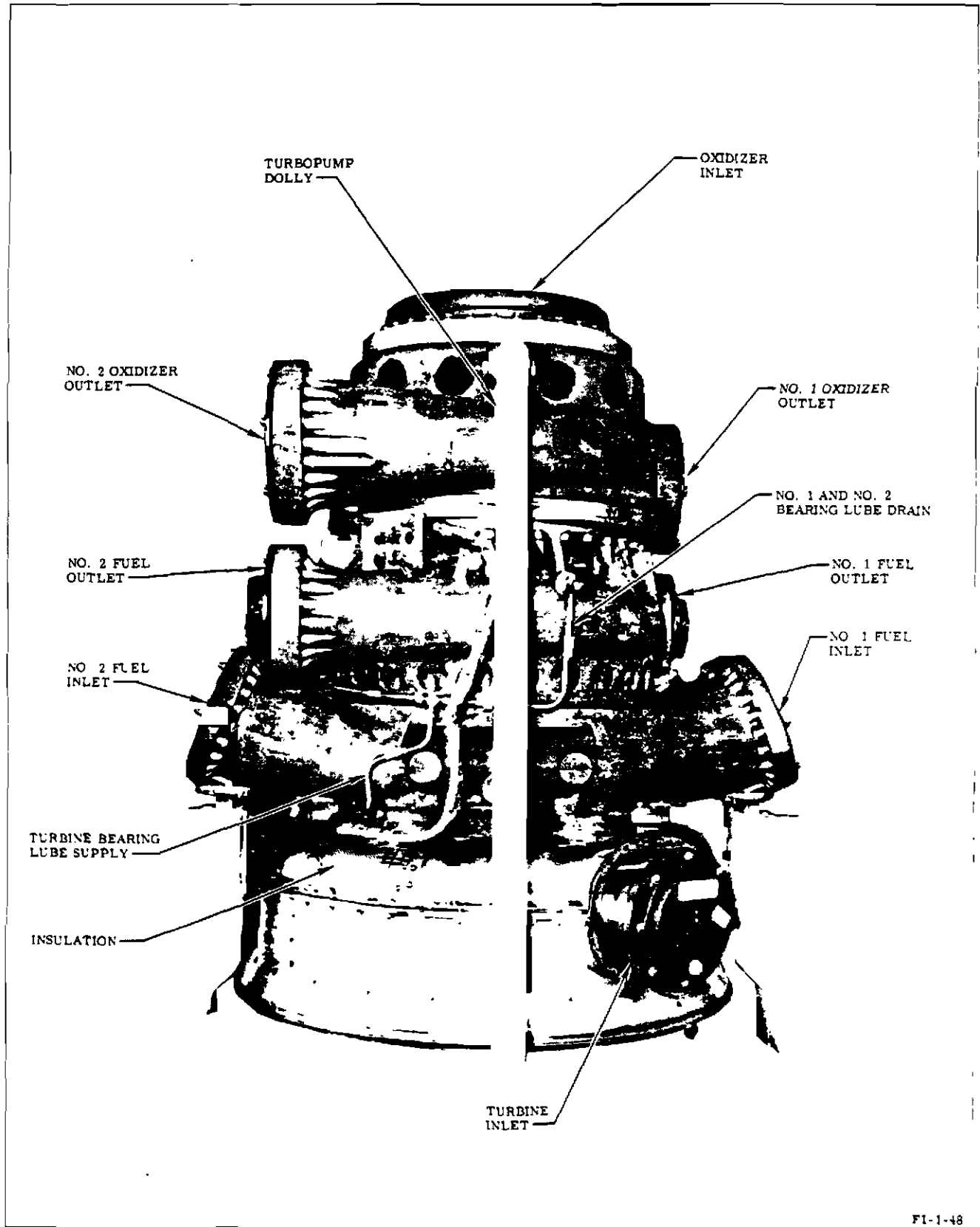

Figure 1-12. Thrust Chamber Nozzle Extension



F1-1-48

Figure 1-13. Turbopump (Inboard)

Change No. 7 - 18 August 1969

1-13

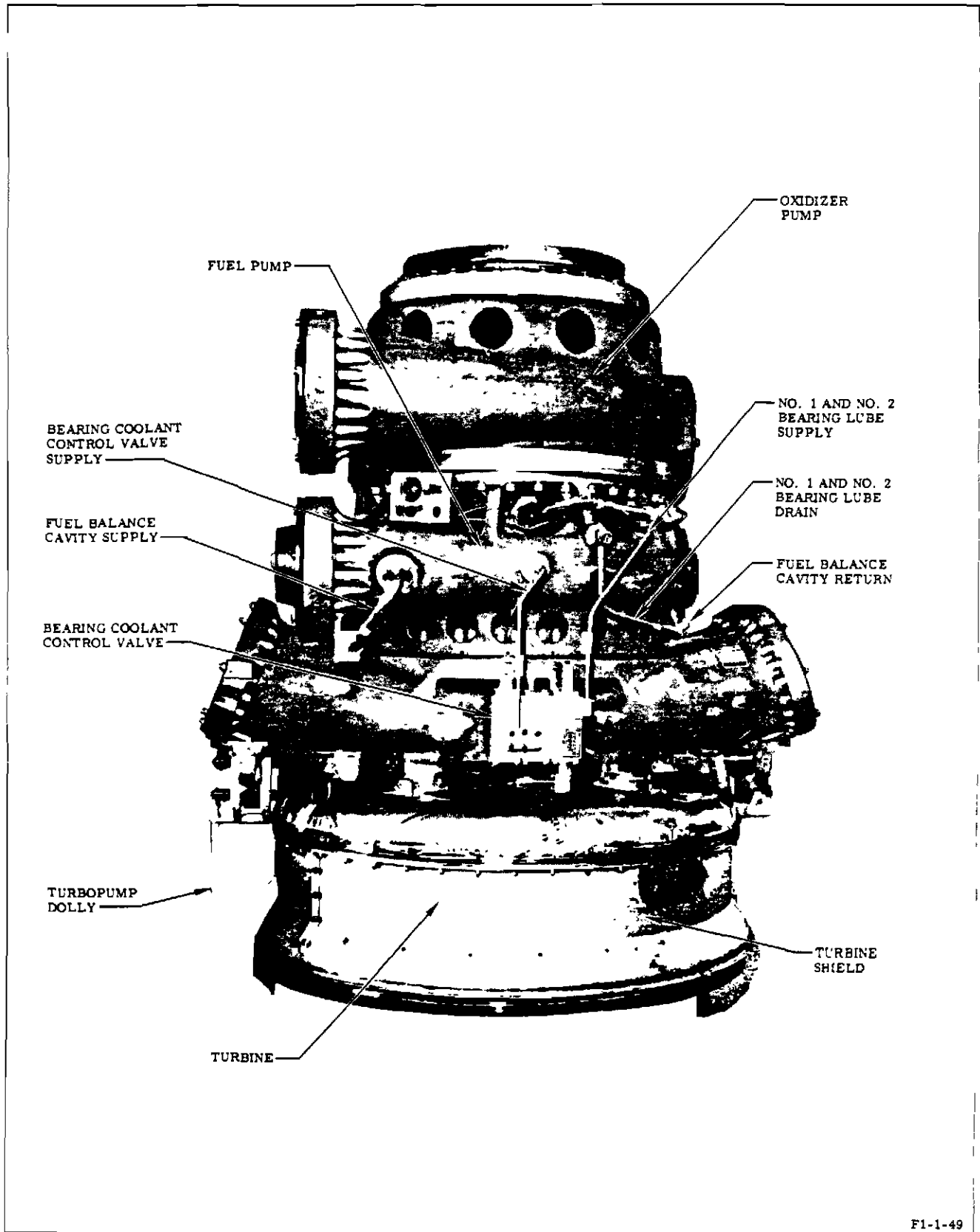

F1-1-49

Figure 1-14. Turbopump (Outboard)

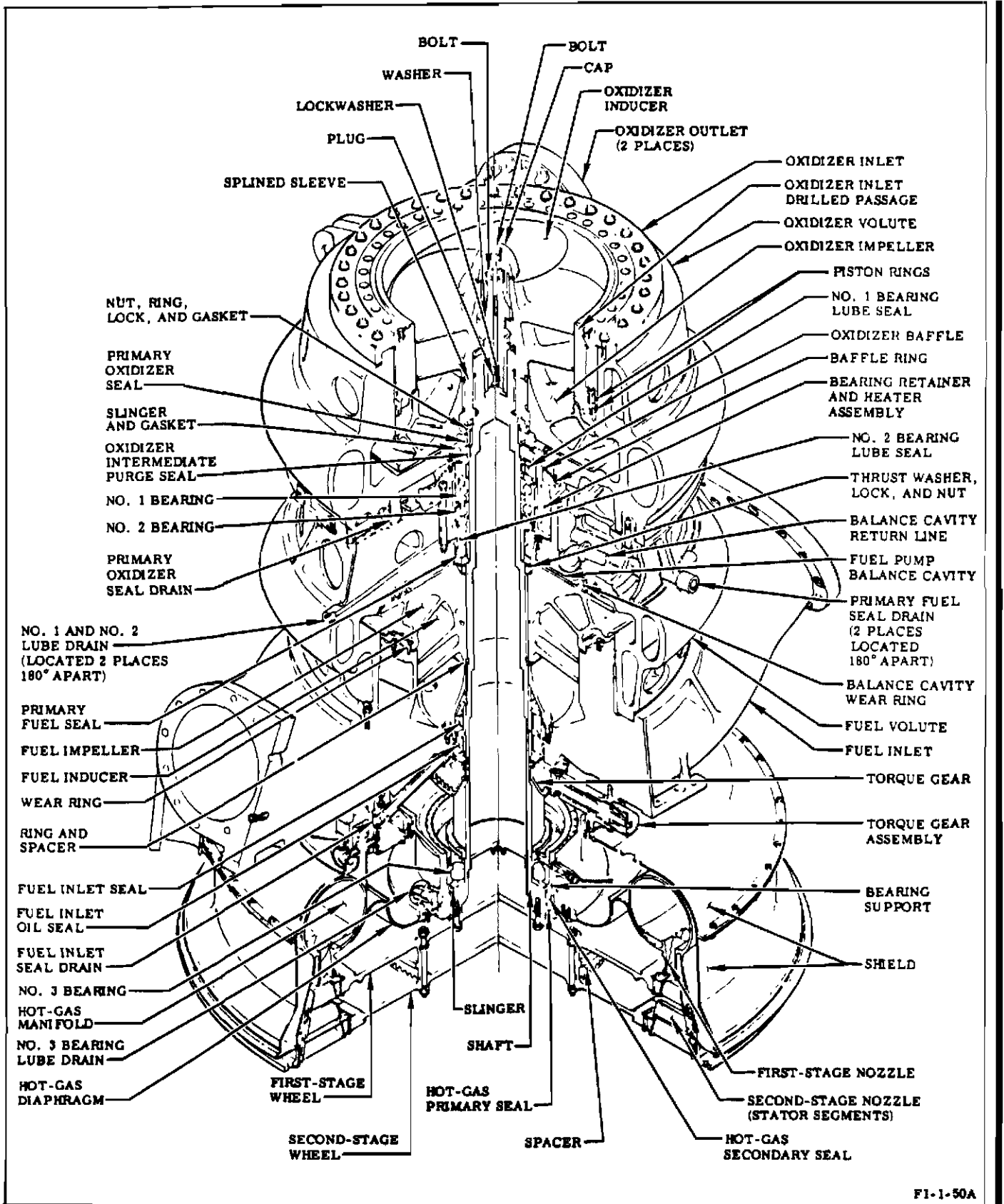

F1-1-50A

Figure 1-15. Turbopump Cutaway

Change No. 8 - 19 February 1970

1-15

1-26. The turbopump contains a balancing system to control the axial thrust loads imposed upon the shaft and ball bearing assemblies by the forces primarily generated by the differential pressure across the oxidizer impeller. The balancing system utilizes the area between the back of the fuel impeller and fuel volute as a balance cavity, to which fuel pressure from the discharge side of the fuel pump is directed and regulated, to partially counterbalance the axial thrust developed by the oxidizer impeller. Manual rotation of the turbopump shaft for the purpose of facilitating turbopump preservation and detecting excessive breakaway and running torque, is provided by a ring and pinion gear combination. The ring gear is splined to the turbopump shaft, and the pinion gear is mounted to the torque gear housing in a spring-loaded, disengaged position. When manual rotation of the pump shaft is required, the pinion gear is pushed in to engage with the ring gear and a rotating force applied. The sleeve of the ring gear contains two holes, spaced 180 degrees apart, which are used in conjunction with a magnetic transducer for monitoring shaft speed during engine operation.

1-27. The turbopump bearings are cooled by pressurized fuel supplied through a bearing coolant control valve to spray nozzles at the bearings. The fuel is routed in parallel from the coolant control valve to the No. 1 and No. 2 bearings and to the No. 3 bearing and is then drained overboard through the fuel overboard drain system. On engines incorporating MD145 change, the parallel routing from the bearing coolant control valve has been replaced by a series system. This change directs the drainage from the No. 1 and No. 2 bearings to splash-lubricate the No. 3 bearing and then overboard through the overboard drain system. Two cal-rod heaters, cast into the retainer block of the No. 1 and No. 2 bearings, prevent condensation and ice from forming on the bearings during engine standby.

1-28. The principal sections of the turbopump consist of an oxidizer pump section, a fuel pump section, and a turbine section. The three sections are structurally connected to each other by pins, which permit relative radial movement to compensate for the effects of thermal differences between the oxidizer, fuel, and turbine sections. A bearing coolant control valve mounted on the fuel pump section supplies

coolant fuel to the bearings contained within the oxidizer pump and turbine sections. (See figure 1-16 for turbopump leading particulars.)

| | |
|--|------------------------------|
| Weight (average) | 3,150 lb |
| Length | 5 ft |
| Diameter | 4 ft |
| Shaft speed | 5,492 rpm |
| Oxidizer pump inlet pressure | 65 psia |
| Oxidizer pump discharge pressure | 1,602 psia |
| Oxidizer pump flowrate | 3,986 lb/sec (25,063 gpm) |
| Fuel pump inlet pressure | 45 psia |
| Fuel pump discharge pressure | 1,870 psia |
| Fuel pump flowrate | 1,756 lb/sec (15,520 gpm) |
| Turbine inlet temperature | 1,453° F |
| Turbine inlet pressure | 945 psia total |
| Turbine exit pressure | 58 psia |
| Turbine brake horsepower | 53,146 bhp |
| Bearing coolant flowrate (parallel system) | 5.5 gpm |
| Bearing coolant flowrate (series system) | 3.5 gpm |
| Shaft breakaway and running torque | 20 ft/lb max. |

Figure 1-16. Turbopump Leading Particulars (Engines Incorporating MD128 or MD174 Change)

1-29. TURBOPUMP OXIDIZER PUMP DESCRIPTION. The principal parts of the oxidizer pump (figures 1-17 and 1-18) are an inducer, an impeller, a volute, two bearings, and the necessary seals to contain the oxidizer and coolant fuel within their respective areas of the oxidizer pump section. The inducer is splined to the shaft and increases the oxidizer inlet pressure to prevent cavitation and to direct the oxidizer into the inlet of the impeller. The impeller is installed on the shaft through an internally/externally splined coupler and imparts velocity to the fluid. The volute houses and supports the component parts of the oxidizer pump and converts the kinetic energy of fluid velocity to potential energy of fluid pressure. The oxidizer volute incorporates a ring that is pinned within a recess of the volute by 36

radially inserted pins. The fuel volute attaches to this ring by 36 bolts that are axially installed into threaded holes of the ring. Two discharge ports supply oxidizer to respective inlets of the oxidizer dome and manifold assembly. The bearings at the oxidizer pump section (figure 1-18), identified as No. 1 and No. 2 bearings, are a matched set of ball bearings that support the shaft at its forward end and absorb shaft axial loads.

1-30. Four major seals are contained in the oxidizer pump section. No. 1 seal (primary oxidizer seal) is a carbon-nose-to-mate-ring seal that seals the oxidizer propellant area from the bearing coolant fuel area. Leakage past this seal is directed overboard through the oxidizer overboard drain line. No. 2 seal (intermediate oxidizer seal) is a carbon-segmented seal with the spring-loaded carbon segments riding against the pump shaft and is a backup seal to isolate the oxidizer from the fuel coolant. A nitrogen gas purge is applied between the two segment layers and flows axially in both directions between the faces of the carbon segments and the shaft. Because carbon seals are primarily dynamic seals, the purge acts as a positive pressure barrier to isolate the oxidizer and bearing coolant from each other under static conditions. The purge flow to the oxidizer side of the seal is directed overboard through the same line that drains the primary oxidizer seal cavity.

1-31. No. 3 seal (No. 1 bearing lube seal) is a carbon-nose-to-mate-ring seal, which is the forward seal to confine the bearing coolant fluid within the bearing retainer and heater assembly. Leakage past No. 3 seal, along with the purge gas flowing from the coolant side of the intermediate oxidizer seal, is directed overboard by the nitrogen purge overboard drain line. No. 4 seal (No. 2 bearing lube seal) is a carbon-nose-to-mate-ring seal, which is the rear seal to confine the bearing coolant fluid within the bearing retainer and heater assembly. Leakage past No. 4 seal is directed to the fuel drain manifold by the primary fuel seal drain lines. Additional seals of the oxidizer pump section include two KEL-F coated, CRES, split piston rings, a Teflon-coated Naflex seal, and KEL-F wear-ring seal. The split piston rings recess into grooves of the oxidizer inlet and seal the interface of the oxidizer inlet skirt and volute wall. Any leakage past both seals is directed back to

the inlet side of the pump through radial passages drilled in the oxidizer inlet assembly. The Naflex seal is installed between the attach flanges of the oxidizer inlet and the oxidizer volute. The KEL-F wear ring is a labyrinth seal attached to the oxidizer inlet. The wear ring effectively seals the high-pressure side of the pump from the low-pressure side by placing a series of orifices and expansion areas between the two sides. Synthetic rubber O-rings are also used in the carbon seal assemblies and in the bearing retainer and heater assembly.

1-32. TURBOPUMP FUEL PUMP DESCRIPTION.

The principal parts of the fuel pump section (figures 1-17 and 1-18) are an inlet assembly, an inducer, an impeller, a volute, and the necessary seals to contain the fuel within the fuel section of the pump. The fuel inlet assembly is a dual inlet manifold that directs fuel to the inducer. The inlet assembly is bolted to the fuel volute on the top side and to the torque gear housing on the bottom. Six clevis fittings on the turbine section are bolted to the fuel inlet assembly to provide the primary structural interface between the fuel pump section and the turbine section. The inducer is splined to the shaft and increases the fuel inlet pressure to prevent cavitation and to direct the fuel into the eye of the impeller. The impeller is splined to the shaft and imparts velocity to the fluid. The volute converts the kinetic energy of fluid velocity to potential energy of fluid pressure. Thirty-six bolts connect the fuel volute to a pinned ring of the oxidizer volute to provide the primary structural interface between the fuel pump section and the oxidizer pump section. The fuel volute incorporates two discharge ports to supply fuel to the respective inlets of the thrust chamber fuel inlet manifold.

1-33. Three major seals are contained in the fuel pump section: No. 5, No. 6, and No. 7 seals. No. 5 seal (primary fuel seal) is a carbon-nose-to-mate-ring seal, which seals the shaft area of the balance cavity. Any leakage past this seal, along with any leakage past the No. 4 seal, is directed to the fuel drain manifold by the primary fuel seal drain lines. No. 6 seal (fuel inlet seal) is a carbon-nose-to-mate-ring seal and seals against leakage from the fuel inlet. Any leakage past this seal is directed to the fuel drain manifold by the fuel inlet seal drain lines.

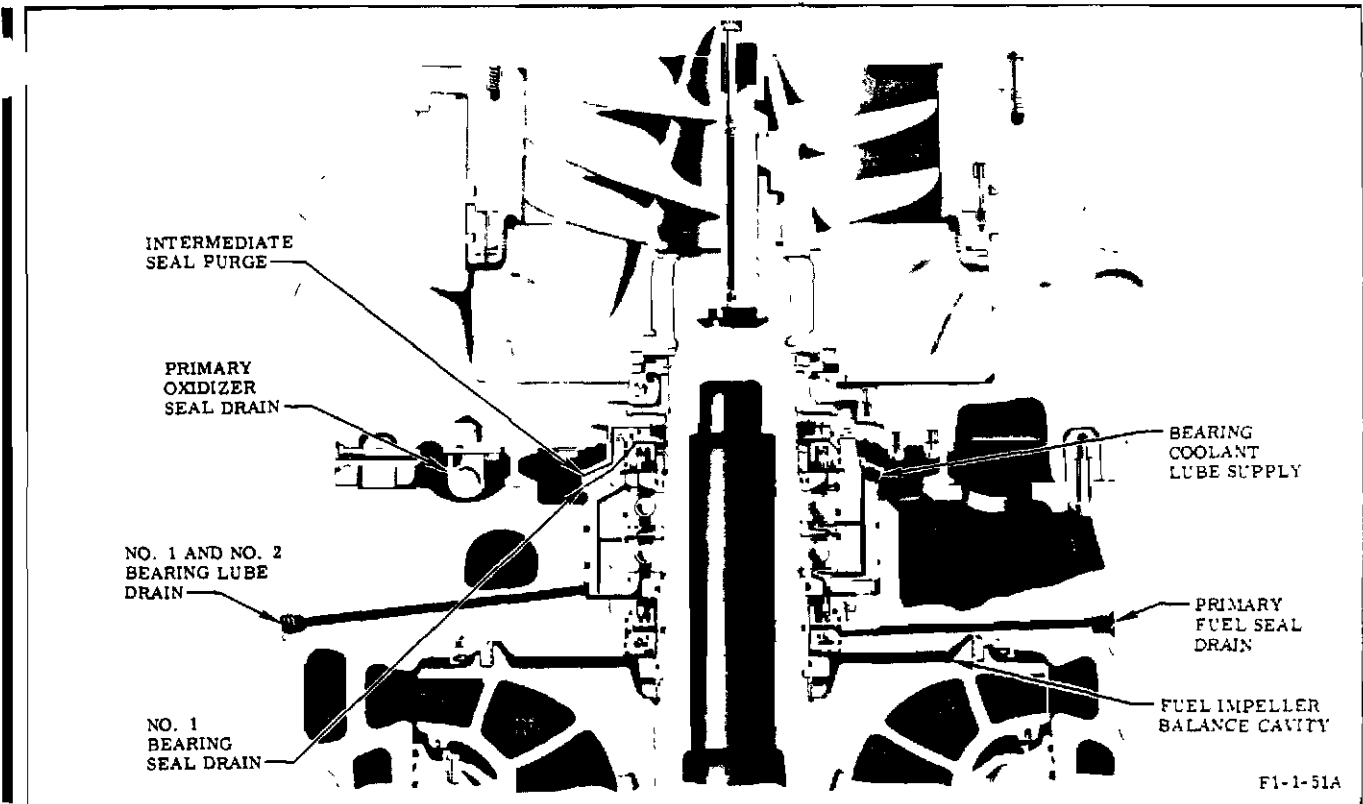

Figure 1-17. Oxidizer Pump and Fuel Pump

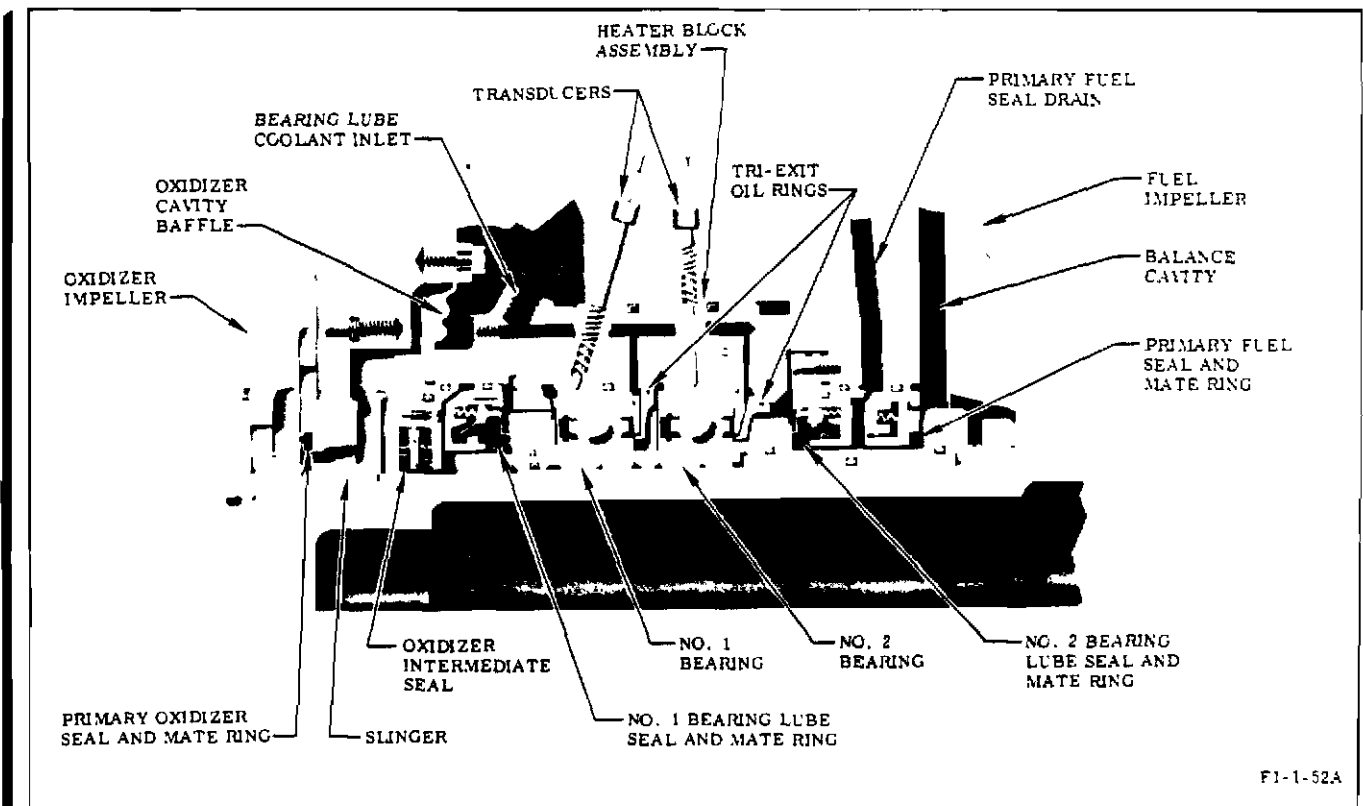

Figure 1-18. Oxidizer Pump and Fuel Pump Bearings

1-34. No. 7 seal (fuel lube seal) is a carbon-nose-to-mate-ring seal and prevents leakage of coolant fuel from the bearing support area. Any leakage past No. 7 seal would be directed to the fuel drain manifold, along with any leakage past the No. 6 seal, by the fuel inlet seal drain lines. Additional seals of the fuel pump section include three synthetic rubber O-rings and two lead-plated brass wear rings. Two of the synthetic O-rings seal the interface of the fuel inlet skirt and wall of the volute. The other O-ring seals the interface of the torque gear housing and fuel inlet. One of the wear rings, which is a labyrinth-type seal bolted to the fuel inlet assembly, effectively seals the high-pressure side of the pump from the low-pressure side by placing a series of orifices and expansion areas between the two sides. The other wear ring, which is bolted to the volute and extends into a groove in the backside of the impeller, is a labyrinth-type seal and, in conjunction with the primary fuel seal, establishes the outer and inner diameters of the fuel balance cavity.

1-35. **TURBOPUMP TURBINE DESCRIPTION.** The principal parts of the turbine section are the turbine inlet manifold, two turbine wheels, one bearing, and the necessary seals to contain the hot gas within the turbine section. (See figure 1-19.) The turbine inlet manifold houses the component parts of the turbine section and incorporates six spools to provide the structural interface between the turbine section and the fuel pump section. Each spool has an individually matched clevis fitting, which bolts to the fuel pump inlet, and a clevis pin, which are identified with the manifold serial number and a dash number corresponding to the spool position to which they are matched.

1-36. The turbine manifold incorporates an inlet flange to which the gas generator combustor is attached and an outlet flange for the attachment of the heat exchanger. A nozzle assembly welded to the inlet manifold directs the gas generator gases onto the blades of the first-stage turbine wheel, and 10 nozzle segments bolted to the inlet manifold direct gases from the first-stage turbine onto the blades of the second-stage turbine wheel.

1-37. Each turbine wheel consists of a disc incorporating a series of fir tree slots in its outer periphery into which blades are inserted and riveted in place. The first-stage wheel is bolted to and interfaces with the main shaft

through curvic coupling that absorbs the high shear loads experienced during engine start. The second-stage wheel is bolted to the first-stage wheel through a dual curvic coupler spacer. The bearing in the turbine section is identified as the No. 3 bearing and is a roller bearing that supports the main shaft at the turbine end and absorbs radial loads imposed on the shaft. The bearing is supported by the turbine bearing support assembly, which is bolted to the torque gear housing and the turbine inlet manifold assembly.

1-38. Two major seals are contained in the turbine section: No. 8 and No. 9 seals. No. 8 seal (hot-gas secondary seal) and No. 9 seal (hot-gas primary seal) are both carbon segmented seals with the spring-loaded segments riding against the pump shaft. The seals isolate the turbine section hot gases from the No. 3 bearing. Other seals in the turbine section consist of two pressure-actuated seals and a honeycomb seal. One of the pressure-actuated seals, which is installed at the interface of the hot-gas secondary seal housing and the bearing support assembly, seals against leakage of coolant fluid into the turbine inlet manifold. The other pressure-actuated seal, which is installed at the interface of the bearing support assembly and the turbine inlet manifold assembly, seals against leakage of hot gas from the turbine inlet manifold. The honeycomb seal is an Inconel honeycomb circular strip positioned on the inner wall of the turbine inlet manifold at the area of the first-stage turbine wheel. The seal in conjunction with two machine serrations on the turbine wheel blades is a labyrinth-type seal that effectively prevents the bypassing of gas around the periphery of the wheel.

1-39. **BEARING COOLANT CONTROL VALVE DESCRIPTION.** The bearing coolant control valve (figure 1-20) controls the coolant fuel flow to the turbopump bearings and provides a means of supplying preservative compound to the bearings. It is a normally closed, spring-loaded, pressure-actuated poppet valve, embodying redundancy to assure positive delivery of coolant fluid. The valve assembly consists of two coolant and one preservative-oil poppet valves, three 40-micron filters, a restrictor to meter the coolant fuel, and a housing that incorporates a quick-disconnect for attaching the preservative-oil supply line. The redundant fuel coolant poppets offset when fuel pump discharge pressure reaches a nominal 225 psig and directs the

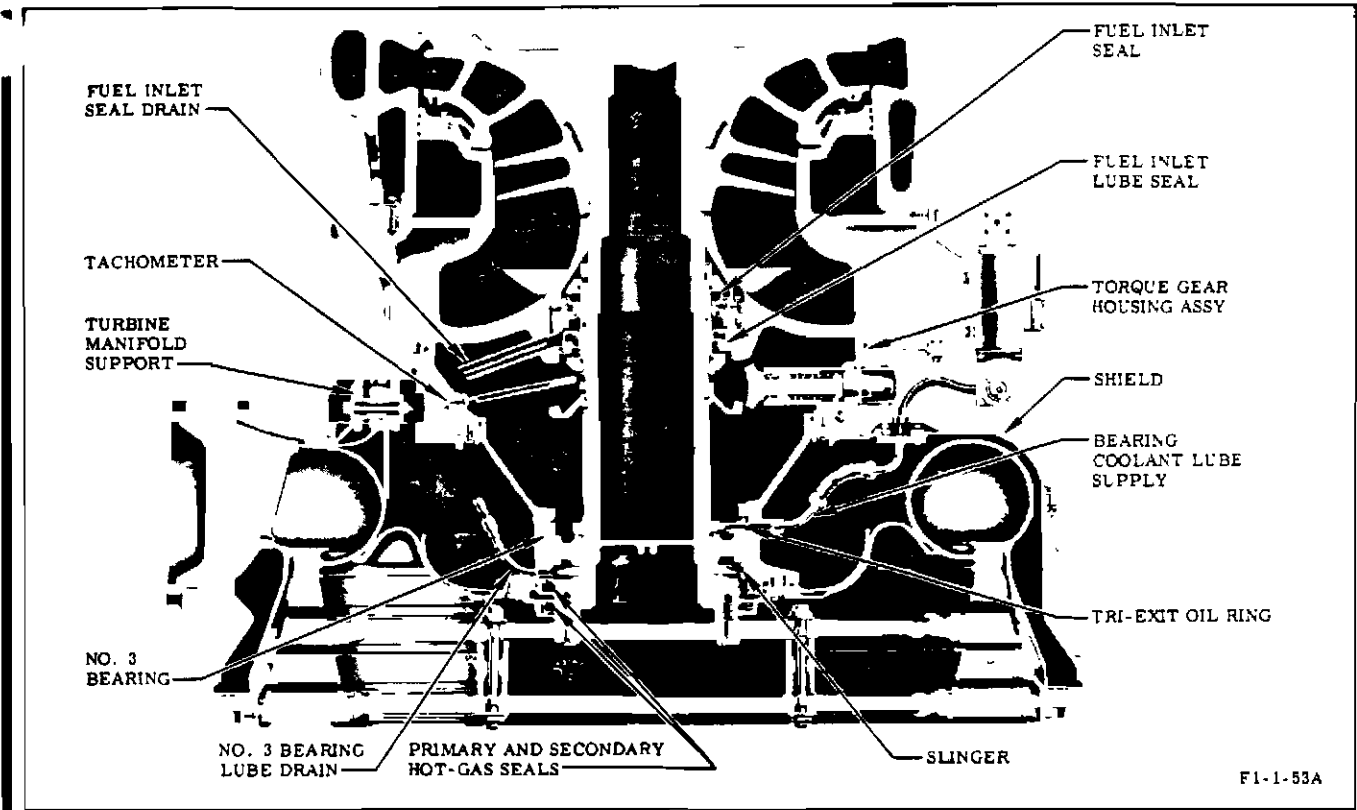

Figure 1-19. Fuel Pump and Turbine

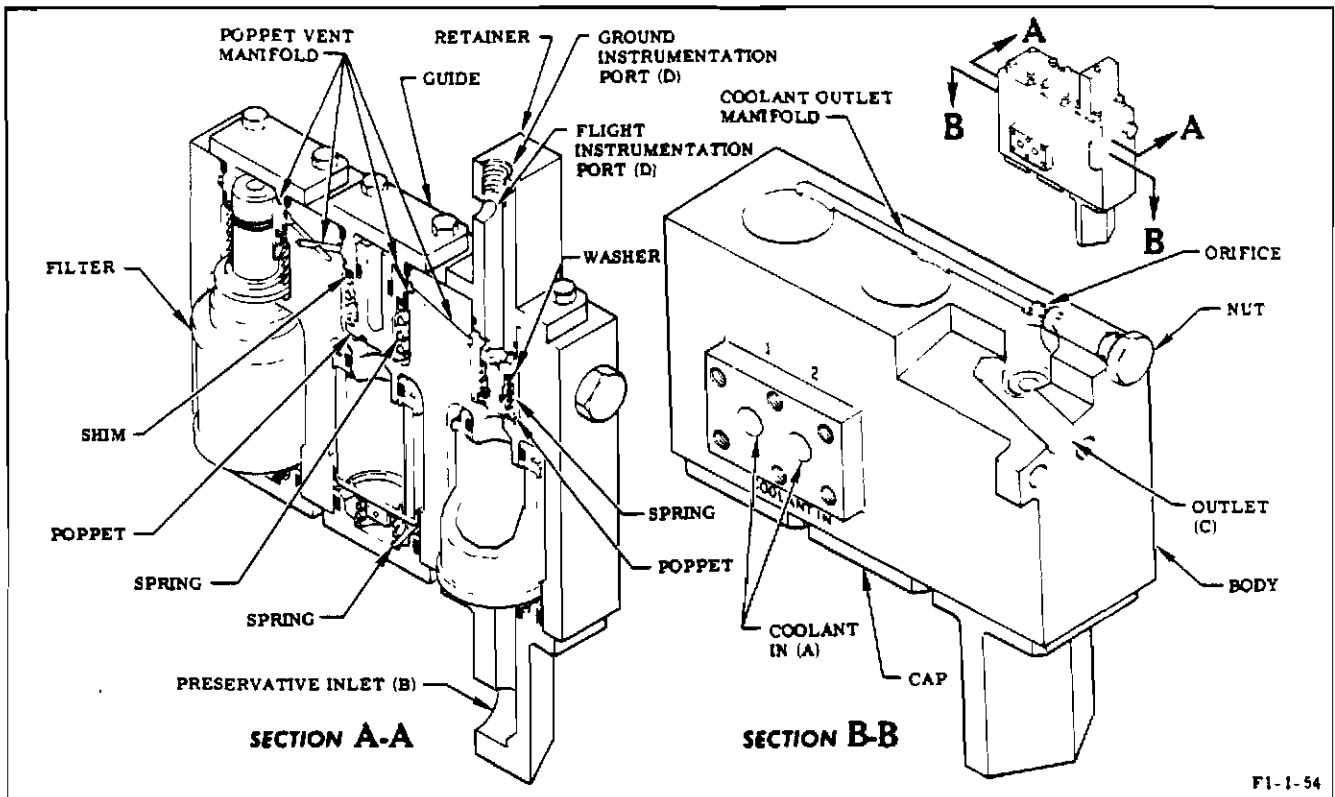

Figure 1-20. Bearing Coolant Control Valve

coolant through the restrictor to the turbopump bearings. The restrictor is sized during engine acceptance testing to provide a bearing pressure of 200-540 psig. The preservative-oil poppet offseats during preservation procedures at 9-20 psig and directs the preservative oil to the turbopump bearings. On engines incorporating MD145 change, the port for the turbine bearing jet ring is capped and the orifice is changed to accommodate the series lube system.

1-40. TURBOPUMP FUEL INLET ELBOW

DESCRIPTION. The turbopump fuel inlet elbows (No. 1 and No. 2) are single-inlet, dual-outlet elbows incorporating internal flow vanes. Fuel flows radially into the fuel pump inlet assembly from the two inlet elbows mounted 180 degrees apart. Lifting studs are provided on the elbows for ease of handling. Seal monitoring ports are provided on the downstream outlet flanges. One attach point for support of the engine interface panel is located on each elbow, and attach points are located on the duct side of the elbow for fastening a flexible (rubber) thermal insulation boot around the blow to the engine interface panel. The No. 2 elbow has a flanged attach point for the checkout valve engine return hose.

1-41. OXIDIZER VALVE DESCRIPTION.

1-42. The engine has two identical oxidizer valves (figure 1-21) that direct the flow of liquid oxygen to the thrust chamber and the flow of hydraulic control opening fluid to the gas generator control valve. The oxidizer valves are hydraulically actuated, spring-loaded closed, pressure-balanced, fail-to-the-run position, poppet-type valves having quick response and low delta-P operating characteristics. An integral part of each oxidizer valve, and mechanically opened by this valve, is a normally closed sequence valve which, in the open position, directs hydraulic control fluid to the opening port of the gas generator control valve.

1-43. The oxidizer valve is designed so that when it is in the open position, at rated engine oxidizer pressure and flowrate, it will not close if hydraulic control fluid opening pressure is lost. The oxidizer valve consists of a housing that contains the oxidizer inlet and outlet ports and the seat for the poppet seal; a poppet with a machined Teflon seal secured by a seal

retainer; a cover that attaches to the valve housing and contains the two poppet-closing springs and also serves as a mount for the cylinder and a guide for the piston rod; a cylinder, within which the actuating piston operates, that contains the open and closed actuator ports and supports the position indicator drive shaft; a cylinder head that contains the inlet and outlet ports of the sequence valve and also provides a mount for the sequence valve gate; and a tapered piston rod that connects the actuator to the poppet, mechanically opens the sequence valve, and actuates the position indicator.

1-44. The sequence valve is a spring-loaded gate valve that seats against, and is hinged to, the oxidizer valve cylinder head. The sequence valve is offseated by the piston rod to direct opening hydraulic control fluid to the gas generator control valve when the oxidizer valve reaches 16.4 percent of its open position. The position indicator consists of a rotary-motion variable resistor and open and closed position switches. The position indicator is mounted on the oxidizer valve cylinder and is coupled to the indicator drive shaft, which is mechanically linked to the piston rod. The position switch provides relay logic in the engine electrical control circuit, and the variable resistor provides instrumentation for recording valve poppet movement.

1-45. Each oxidizer valve incorporates an oxidizer dome purge check valve to admit gaseous nitrogen downstream of the valve poppet to purge the thrust chamber oxidizer dome. The check valve is a gate-type valve, spring loaded to the closed position, and allows flow in one direction when the differential pressure across the valve exceeds 5.0 psi. Five types of seals are used in the oxidizer valve: machined Teflon seals, Mylar lip seals, Teflon-coated steel Naflex seals, and Buna-N O-rings. Oxidizer valve leading particulars are listed in figure 1-22.

1-46. FUEL VALVE DESCRIPTION.

1-47. The engine has two identical fuel valves (figure 1-23) to direct fuel to the thrust chamber. The valves are hydraulically operated, spring-loaded-closed, pressure-balanced, fail-to-the-run-position, poppet-type valves having quick

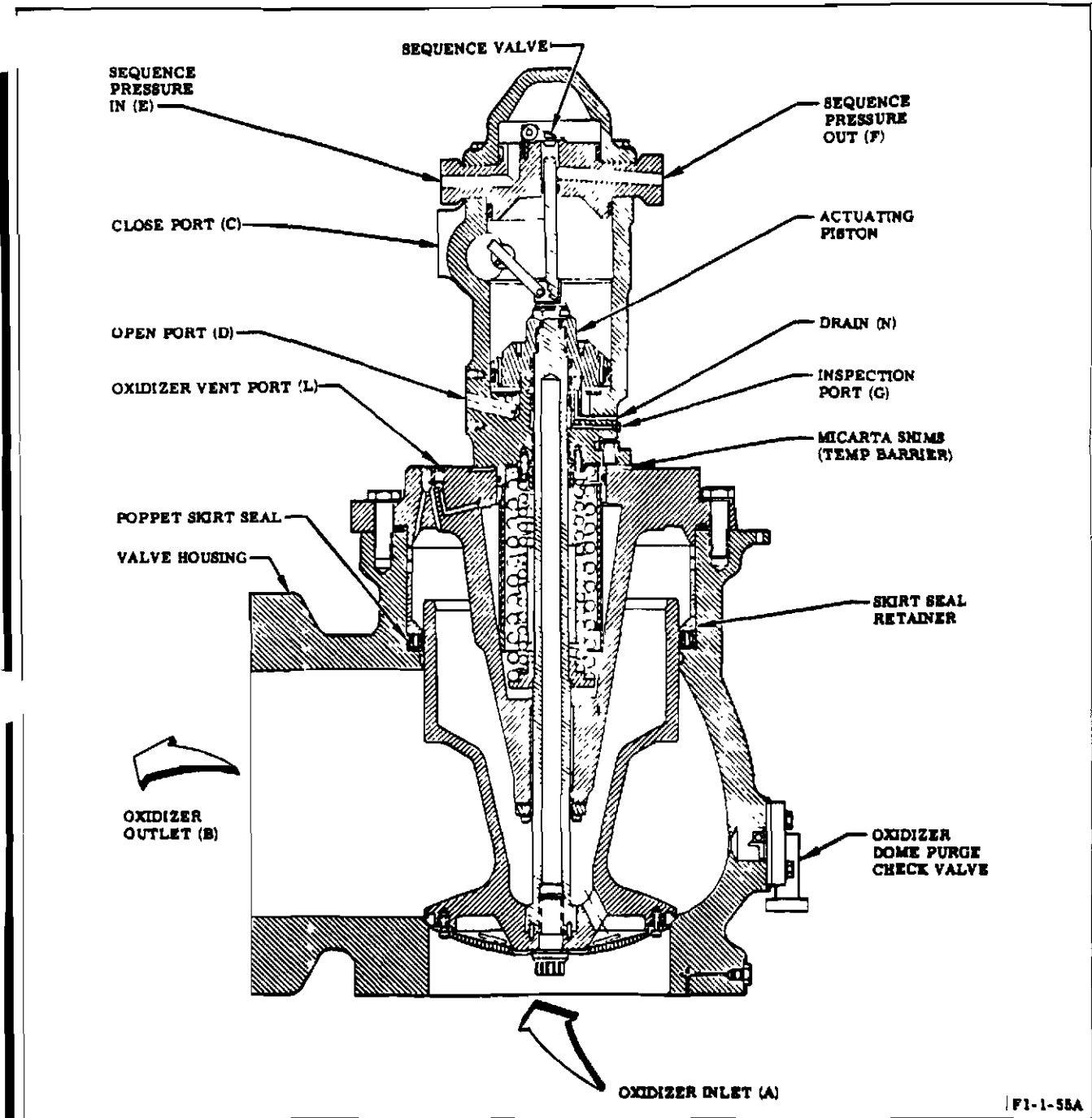

Figure 1-21. Oxidizer Valve

response and low delta-P operating characteristics. The fuel valve is designed so that when it is in the open position, at rated engine fuel pressure and flowrate, it will not close if hydraulic control fluid opening pressure is lost.

1-48. The fuel valve consists of a housing containing fuel inlet and outlet ports, closing and opening ports, a drain port, a purge port, a

poppet seal seat and retainer, a spring-loaded poppet with a machined Teflon seal secured by a seal retainer, an actuator guide internally drilled to provide the open port passage, and a piston that connects to the poppet. The nose seal retainer incorporates 12 radially drilled passages to direct fuel into the balance cavity

during the last portion of valve closing travel. This feature assists the valve in closing by maintaining a positive fluid pressure within the balance cavity. A position indicator attaches to the valve housing and recesses into the piston shaft. The indicator consists of a linear-motion variable resistor and open and closed position switches. The position switches provide relay logic in the engine electrical control circuit, and the variable resistor provides instrumentation for recording valve poppet movement. Three types of seals are used in the fuel valve: machined Teflon seals, Viton-A O-rings, and Buna-N O-rings. Fuel valve leading particulars are listed in figure 1-22.

| | Oxidizer Valve | Fuel Valve |
|-----------------------------|----------------|----------------------|
| Weight | 168.0 lb | 90.0 lb |
| Length | 30.0 in. | 16.0 in. |
| Width | 17.25 in. | 11.0 in. |
| Opening pressure | 200 psig max. | 110 psig max. |
| Closing pressure | 75 psig max. | 0 psig (spring only) |
| Opening time (switch times) | 320 msec | 635 msec |
| Closing time (switch times) | 325 msec | 930 msec |
| Inlet diameter | 8.0 in. | 6.0 in. |
| Outlet diameter | 8.0 in. | 6.0 in. |
| Poppet travel | 2.34 in. | 2.0 in. |
| Poppet seal | Teflon | Teflon |

Figure 1-22. Oxidizer Valve and Fuel Valve Leading Particulars

1-49. OXIDIZER HIGH-PRESSURE DUCT DESCRIPTION.

1-50. The oxidizer high-pressure ducts contain and distribute the oxidizer separately to each of the oxidizer valves and also provide support for the forward end of the turbopump. The ducts are constructed of drawn aluminum tubing, bent in a continuous section. This design provides flexibility to compensate for expansion, contraction, and vibration. Each duct requires a custom spacer at each end. These spacers are machined for a particular engine and are not interchangeable. On engines incorporating MD137 change, the custom spacers

are replaced with selective spacers machined to various dash number sizes. A tap-off flange for the gas generator oxidizer duct is provided on the No. 2 oxidizer high-pressure duct.

1-51. FUEL HIGH-PRESSURE DUCT DESCRIPTION.

1-52. The fuel high-pressure ducts contain and distribute the fuel separately to each of the fuel valves and support the forward end of the turbopump. The construction and design of the fuel ducts provide flexibility to compensate for expansion, contraction, and vibration. Each duct requires a custom spacer at each end. On engines incorporating MD137 change, the custom spacers are replaced by selective spacers with various dash number sizes. Tap-offs for the bearing coolant control valve, gimbal filter manifold, igniter fuel valve, and fuel high-pressure duct drain quick-disconnect are provided on the No. 1 fuel high-pressure duct. Tap-offs for the gas generator fuel duct, engine control valve, No. 2 fuel bleed and fuel high-pressure duct drain quick-disconnect are provided on the No. 2 fuel high-pressure duct.

1-53. ENGINE INTERFACE PANEL DESCRIPTION.

1-54. The engine interface panel (figure 1-24) is mounted above the turbopump oxidizer and fuel inlets. The panel contains the customer connect locations for electrical connectors between the engine and the vehicle. The panel also provides an attach point for thermal insulation attach brackets.

1-55. IGNITION SYSTEM DESCRIPTION.

1-56. The engine ignition system supplies heat energy to initiate combustion in the gas generator combustor, thrust chamber nozzle extension, and the thrust chamber. Five igniters are required for each engine start: two pyrotechnic igniters for the gas generator, two pyrotechnic igniters for the thrust chamber nozzle extension, and a hypergol igniter for the thrust chamber. The pyrotechnic igniters are electrically fired by 500 vac. The pyrotechnic igniters initiate combustion of the fuel and oxidizer in the gas generator and reignite the fuel-rich gas generator exhaust gas in the nozzle

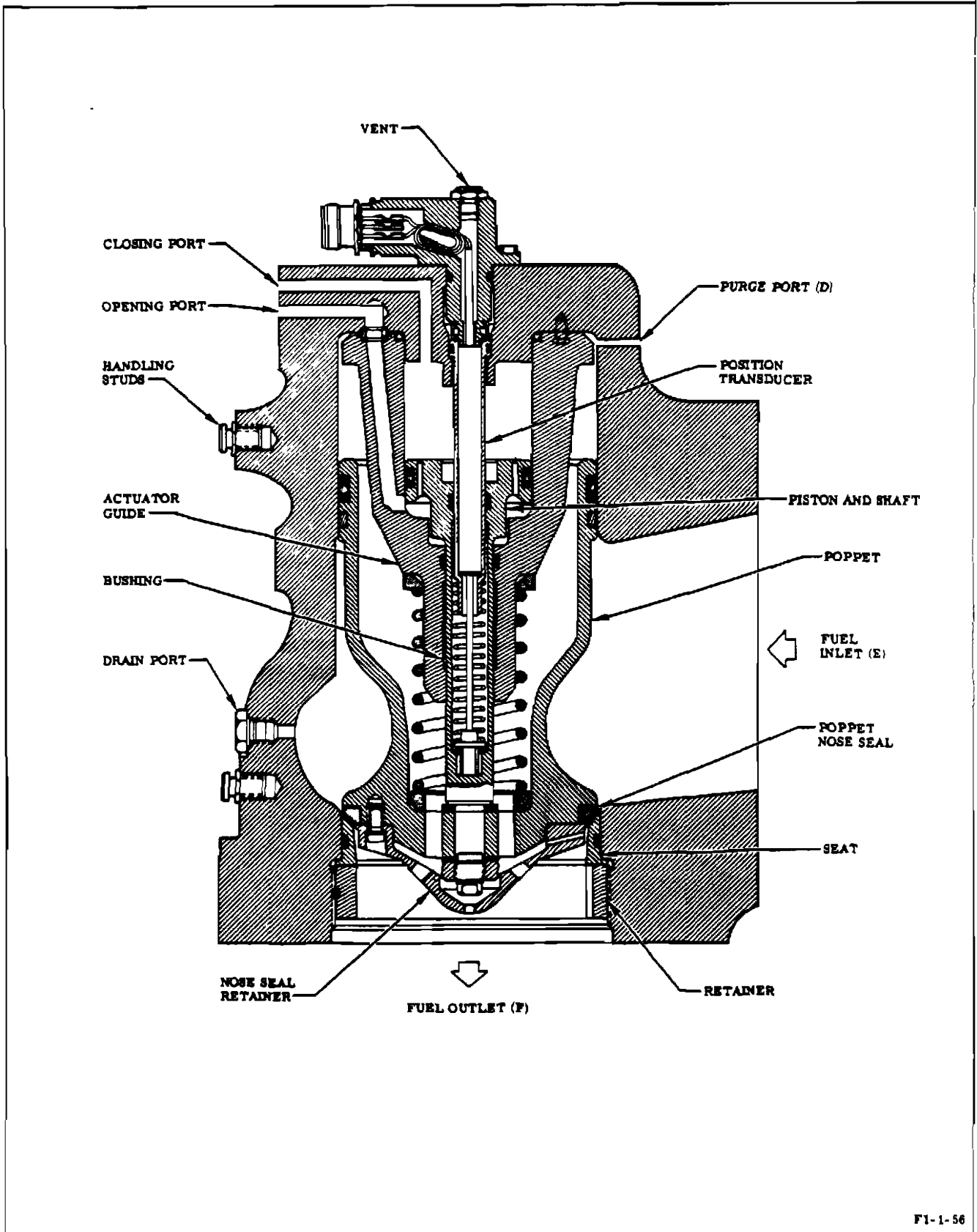

F1-1-56

Figure 1-23. Fuel Valve

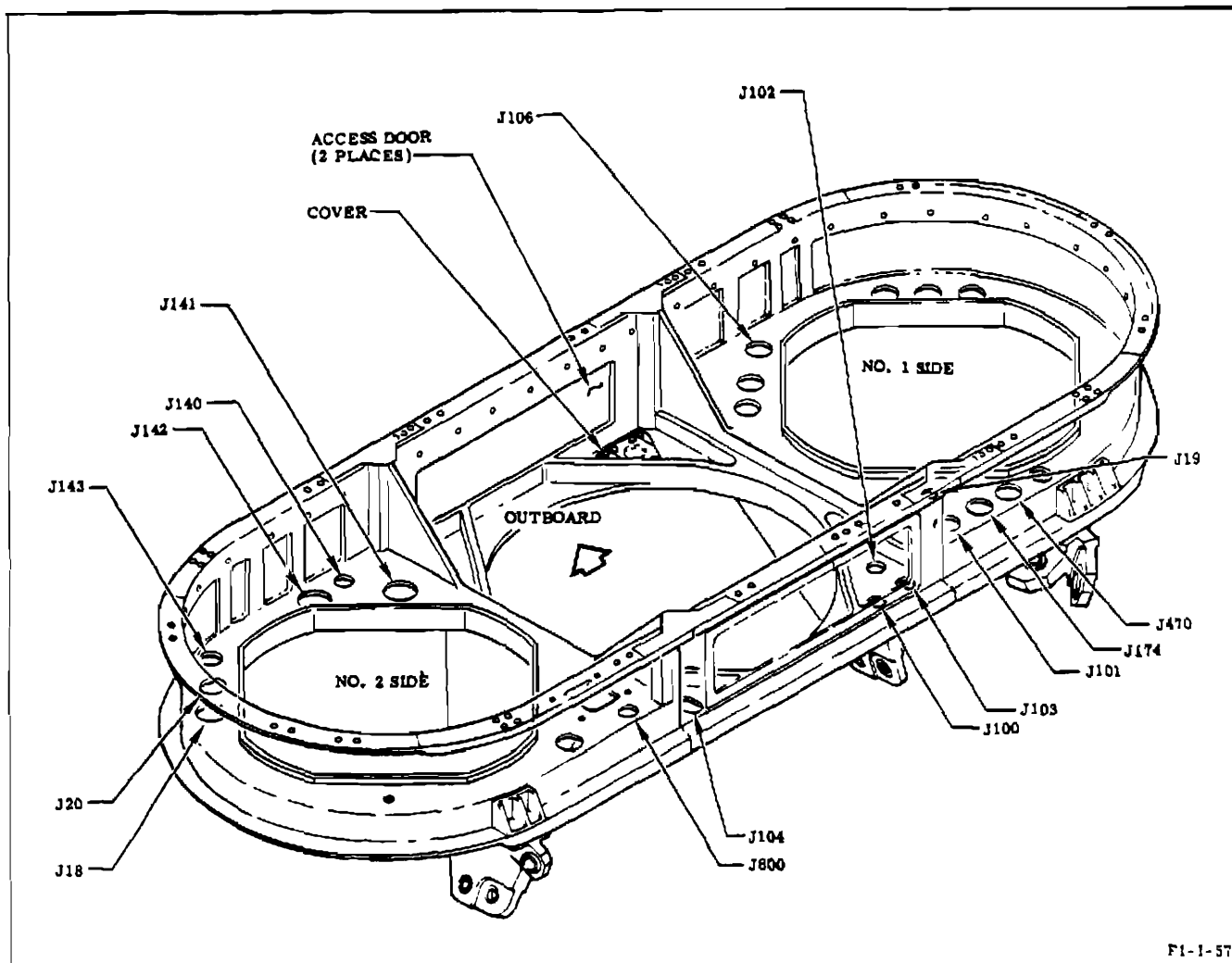

Figure 1-24. Engine Interface Panel

extension. The hypergol igniter initiates combustion in the thrust chamber when fuel pressure from the No. 1 fuel high-pressure duct ruptures the hypergol igniter diaphragms and forces pyrophoric fluid into the thrust chamber through the igniter fuel orifices in the injector.

1-57. HYPERGOL IGNITER DESCRIPTION.

1-58. The hypergol igniter (figure 1-25) contains the pyrophoric fluid that produces initial combustion in the thrust chamber. The igniter is installed in the hypergol manifold by a threaded cap secured by a lockpin. The igniter consists of a cartridge, a plug, a cap, and related seals. The cartridge contains 403 ± 10 grams of pyrophoric fluid consisting of 85 percent

triethylborane and 15 percent triethylaluminum. Two burst diaphragms are welded to the cartridge, one at each end, to contain the pyrophoric fluid within the cartridge. The burst diaphragm at the cap end of the igniter is identified as the downstream diaphragm and has a burst pressure of 350 (+25, -75) psig. The upstream diaphragm has a burst pressure of 500 (+25, -75) psig. The hypergol igniter is approximately 18 inches in length and 2-3/8 inches in diameter.

1-59. PYROTECHNIC IGNITER DESCRIPTION.

1-60. The pyrotechnic high-voltage igniters (figure 1-26) initiate combustion in the gas generator and reignite the fuel-rich turbine exhaust

four receptacle pins. When an electrical stimulus of 500 vac is impressed on the igniter circuit (BD), the diode is triggered allowing a nominal 4.5 amperes of current to flow and ignite the squib. The flame and hot particles from the squib ignite the main pyrotechnic charge. The burning of the main charge severs the link wire imbedded in the charge within 200-800 milliseconds and continues burning for 6.5 to 9.5 seconds. Severing of the igniter link wire provides a positive signal to the engine electrical control system that the igniter has functioned satisfactorily. When 250 vac or less is impressed on the squib circuit, the diode prevents current flow and the igniter will not fire.

1-61. GAS GENERATING SYSTEM DESCRIPTION.

1-62. The gas generating system provides the internal power required to operate the engine. Utilizing tank-head energy from the vehicle, the gas generating system develops sufficient power to start the engine and changes to its rated power level of operation by using a portion of its own output (bootstrapping). The internal power is generated by tapping propellants from the high-pressure ducts and directing them to the gas generator where hot gas is produced to power the turbopump. After impacting the two-stage turbine, the gas is further utilized by a heat exchanger where additional heat is extracted to condition the gases used for vehicle tank pressurization. The now relatively cool gas generator exhaust gas is directed into the lower section of the thrust chamber to provide film cooling of the double-wall portion of the nozzle. Orifices in the propellant ducts to the gas generator control the power level of the system to provide a constant mass flowrate to the thrust chamber, thereby insuring a constant thrust output. Gas generator leading particulars are listed in figure 1-27.

1-63. GAS GENERATOR DESCRIPTION.

1-64. The gas generator (figure 1-28) is within a basic envelope 18 by 24 by 28 inches and weighs approximately 220 pounds. The gas

generator consists of a dual ball valve, an injector fuel inlet housing tee, an integral oxidizer dome and injector, and a combustor. Six types of seals are used in the gas generator: silver-plated stainless-steel Naflex and K-seals and copper crush washers for hot-gas applications, Teflon-coated steel K-seals for cryogenic applications, and Buna-N O-rings for fuel applications.

| | |
|---|------------|
| Combustor temperature | 1,453° F |
| Injector end pressure | 980 psia |
| Oxidizer flowrate | 49 lb/sec |
| Fuel flowrate | 118 lb/sec |
| Mixture ratio | 0.416:1.0 |
| Combustor pressure | 33.5 psia |
| drop | |
| Injector pressure drop (oxidizer) | 250 psia |
| Injector pressure drop (fuel) | 145 psia |
| Gas generator ball valve pressure drop (oxidizer) | 55 psia |
| Gas generator ball valve pressure drop (fuel) | 200 psia |
| Orifice pressure drop (oxidizer) | 261 psia |
| Orifice pressure drop (fuel) | 375 psia |
| Line pressure drop (oxidizer) | 76 psia |
| Line pressure drop (fuel) | 43 psia |
| Gas generator ball valve open time (switch to switch) | 170 msec |
| Gas generator ball valve closed (switch to switch) | 90 msec |

Figure 1-27. Gas Generator Leading Particulars (Engines Incorporating MD128 or MD174 Change)

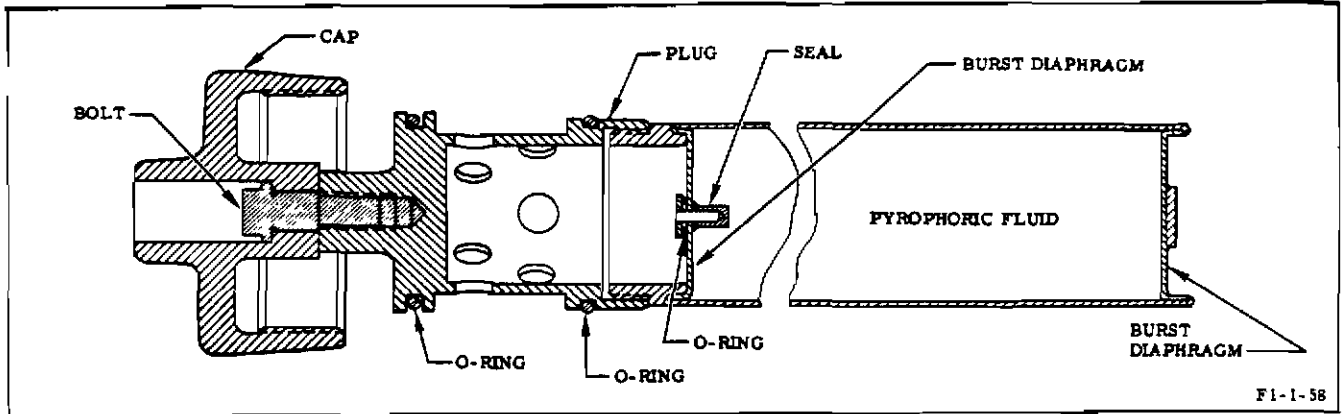

Figure 1-25. Hypergol Igniter

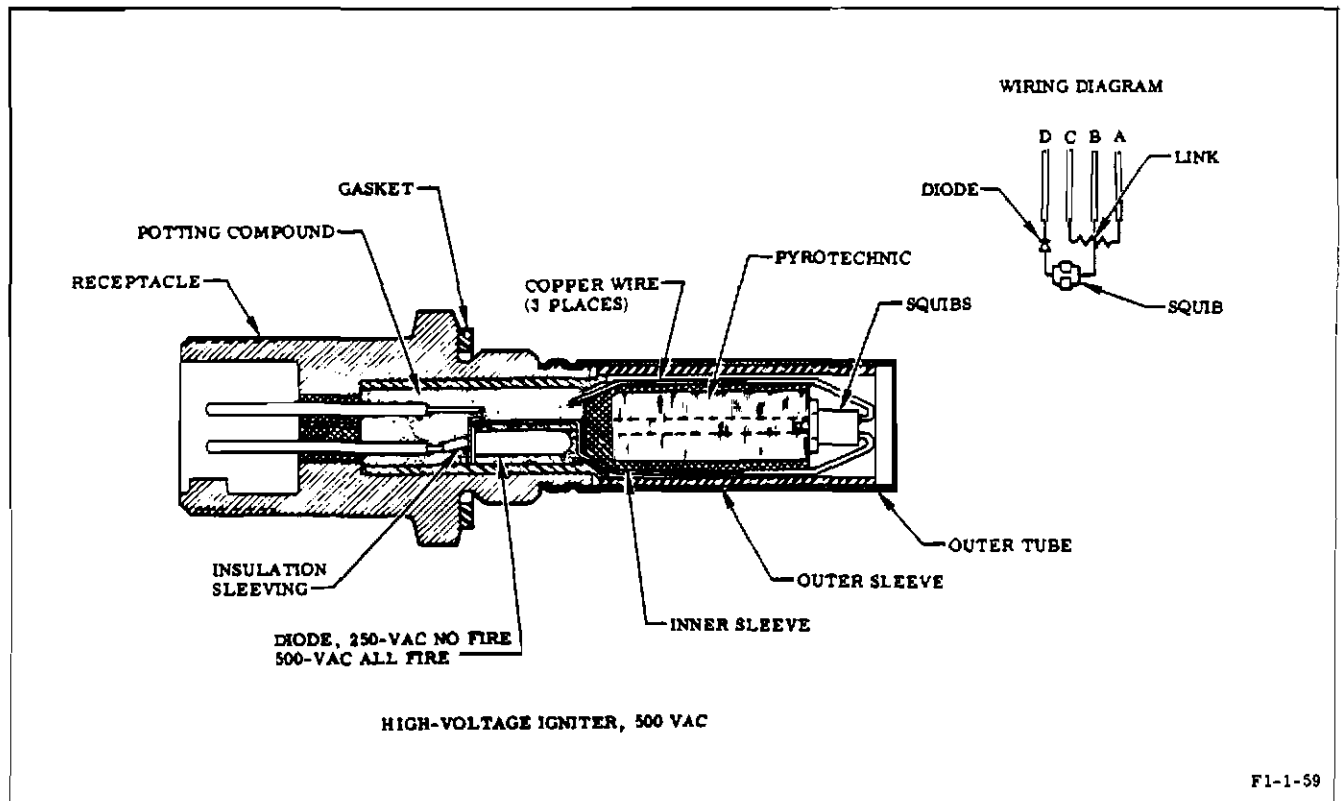

Figure 1-26. Pyrotechnic Igniter

gas in the nozzle extension. Two igniters are installed in igniter bosses of the gas generator combustor inlet flange, and two igniters are installed in bosses in the nozzle extension near the 11:1 expansion ratio area. The igniter external structure consists of a metal tube crimped and soldered at one end into a receptacle with

four electrical contact pins. The opposite end of the tube is sealed with a disc of silver alloy foil. Internally, the igniter has two plastic sleeves, a dual-element squib assembly, a main pyrotechnic charge, a diode, and the wire required to connect the two igniter circuits to the

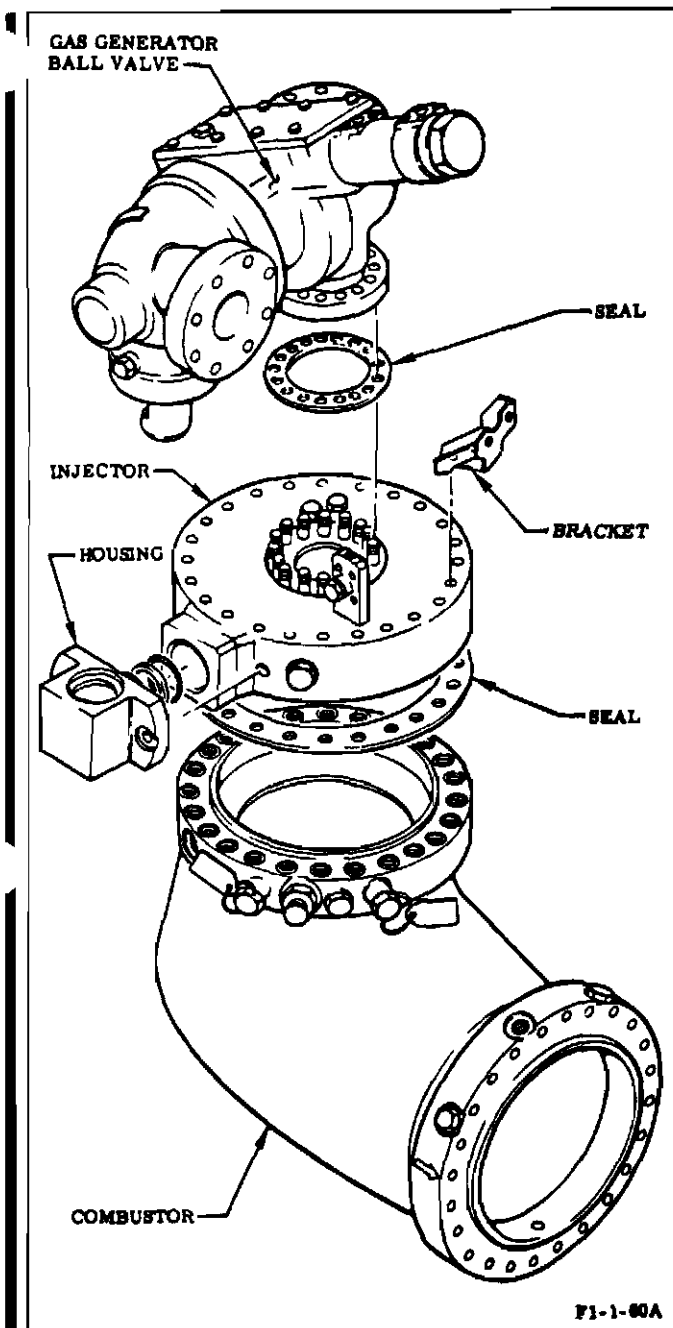

Figure 1-28. Gas Generator

1-65. GAS GENERATOR BALL VALVE DESCRIPTION. The gas generator ball valve (figure 1-29) is a hydraulically operated valve incorporating two hollow balls connected to a single actuator for directing propellants into the gas generator injector. The balls are shells on shafts, each shell having an inlet and outlet flow passage. The inlet and outlet flow passages are located diametrically opposite each other in the oxidizer ball and 150 degrees apart in the fuel ball. A tube is welded between the inlet and outlet passages in the fuel ball to reduce flow resistance. Both balls seat against bellows-type seals. The fuel bellows seal incorporates a deflection elbow for the fuel outlet that is contoured to reduce pressure drop in the gas generator fuel system. Both ball shafts rotate on roller bearings, and each ball also rotates against the actuator housing on roller bearings and races.

1-66. The gas generator ball valve contains a linear-motion position switch and an integral electrical connector, mounted in the valve cover. The housing cover contains tapped holes for installation of Stage Contractor thermocouples. The cover is used to seal the switch compartment. The ball valve oxidizer outlet attaches directly to the gas generator injector oxidizer inlet. The gas generator fuel inlet housing tee connects the ball valve outlet to the injector fuel inlet. The gas generator ball valve opening is directed by sequence valves on the oxidizer valves. Hydraulic fluid recirculates through a warmant passage in the fuel ball housing, preventing the fuel in the fuel ball housing from freezing, and through a passage in the piston between the opening port and the closing port, preventing air entrapment and hydraulic fluid freezing. Four types of seals are used in the gas generator ball valve: machined KEL-F seals, KEL-F lip seals, Buna-N O-rings, and a Teflon-coated steel Naflex seal.

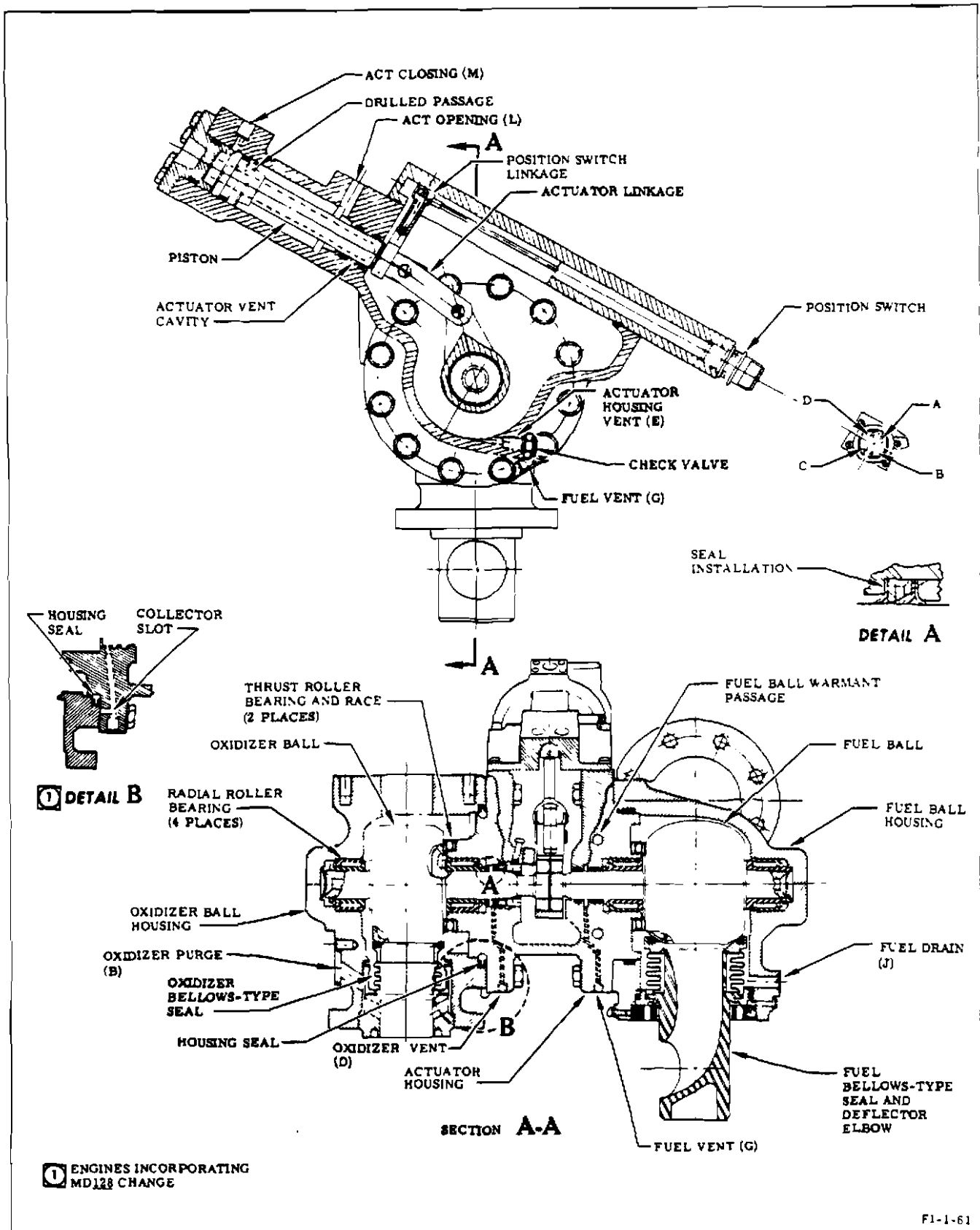

Figure 1-29. Gas Generator Ball Valve

Change No. 8 - 19 February 1970

1-67. **GAS GENERATOR INJECTOR DESCRIPTION.** The gas generator injector (figure 1-30) is a flat-faced, multi-orificed-type injector incorporating a dome, a plate, a ring manifold, five oxidizer rings, five fuel rings, and a fuel disk. The injector is mounted on the combustor, and the gas generator ball valve and the gas generator fuel inlet housing tee are mounted on the injector. The injector directs fuel and oxidizer into the gas generator combustor. Fuel enters the injector through the gas generator fuel inlet housing tee from the gas generator ball valve. The fuel is directed through radial passages in the plate and injected into the combustor through orifices in the five fuel rings and the fuel disk. Oxidizer enters the injector through the oxidizer inlet manifold from the gas generator ball valve. The oxidizer is directed from the oxidizer manifold through internal passages in the plate and is injected into the combustor through the orifices in the five oxidizer rings. The injector uses a double-orificed pattern in which the fuel and oxidizer rings are drilled in a pattern and angle so that the stream from one oxidizer orifice will impinge upon the stream from another oxidizer orifice, and the stream from a fuel orifice will impinge upon the stream from another fuel orifice. Orifices in the outer fuel ring also provide a cooling film of fuel for the combustor choke ring wall.

1-68. **GAS GENERATOR COMBUSTOR DESCRIPTION.** The gas generator combustor (figure 1-30) is a welded single-walled manifold connecting the gas generator injector and the turbine inlet. The combustor contains a chamber for burning propellants and for exhausting the gases from the burning propellants into the turbopump turbine manifold. The combustor is thermally insulated by a sheet metal shell that bolts around the combustor body. The inlet flange is the attach point for the injector and dome assembly and incorporates a 45-degree lip section that deflects the flame pattern to the bottom section of the combustor. Also incorporated in the inlet flange are the two bosses (45 degrees apart) for pyrotechnic igniter installation and two ports (150 degrees

apart) to monitor gas pressure at this point. A port to measure or vent seal leakage past the seal between the injector and combustor is also located on the combustor inlet flange. The combustor outlet flange, which is the attach point for the turbine manifold, incorporates two ports (90 degrees apart) to monitor gas pressure and one port to vent or measure seal leakage past the seal at this interface. Combustor wall temperatures are held to safe operating limits by the combination of film coolant provided by the outer fuel ring of the injector, and the fuel-rich mixture ratio with which the gas generator operates.

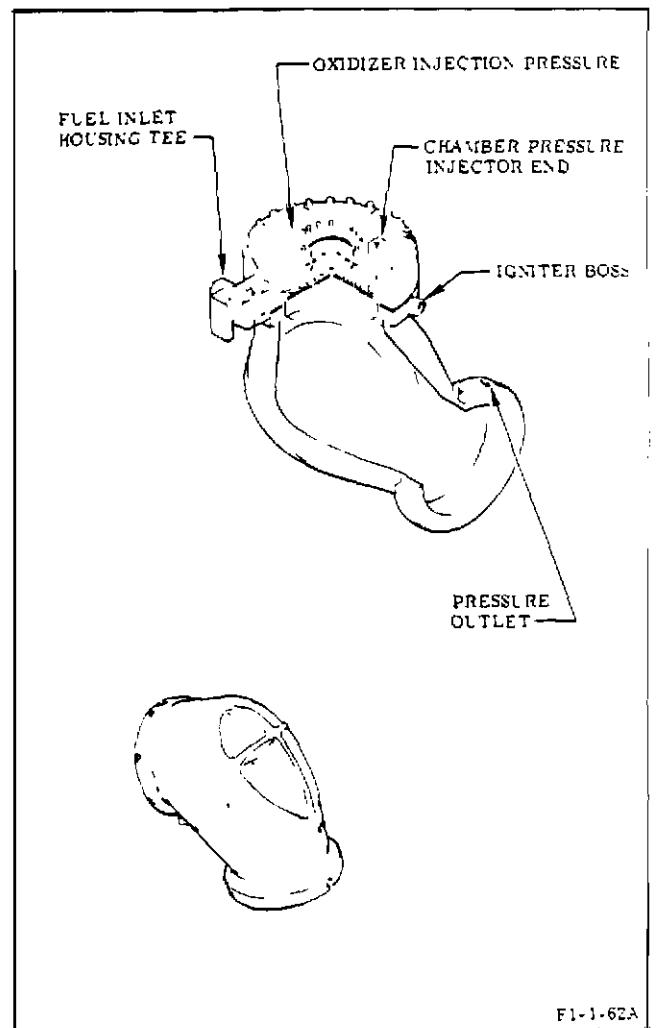

Figure 1-30. Gas Generator Injector and Combustor

1-69. **GAS GENERATOR OXIDIZER DUCT DESCRIPTION.** The gas generator oxidizer duct contains and distributes the oxidizer from the No. 2 turbopump oxidizer outlet duct to the gas generator ball valve oxidizer inlet. The gas generator oxidizer duct is a two-piece, 1-1/2 inch ID duct incorporating three bellows-connected gimbal joints to allow flexing to accommodate installation tolerances and thermal expansion or contraction of the duct. The gas generator oxidizer duct incorporates two orifices for oxidizer flowrate calibration. One orifice is installed at the interface of the gas generator oxidizer duct and the No. 2 turbopump oxidizer outlet duct, and the other orifice is installed at the interface of the two gas generator oxidizer duct sections. Both orifices are sized at engine acceptance test. A fluid scoop, which extends into the fluid stream of the No. 2 turbopump oxidizer outlet duct, is installed at the interface of the gas generator oxidizer duct and the No. 2 turbopump oxidizer outlet duct.

1-70. **GAS GENERATOR FUEL DUCT DESCRIPTION.** The gas generator fuel duct contains and distributes the fuel from the No. 2 turbopump fuel outlet duct to the gas generator ball valve fuel inlet. The gas generator fuel duct is a one-piece, 2-1/4 inch ID duct incorporating three bellows-connected gimbal joints to allow flexing to accommodate installation tolerances, thermal expansion, and contraction of the duct. The gas generator fuel duct incorporates an orifice for fuel flowrate calibration. The orifice is installed at the interface of the gas generator fuel duct and the No. 2 turbopump fuel outlet duct. The orifice is sized during the engine acceptance test. A flow deflector is installed at the interface of the gas generator fuel duct and the gas generator ball valve fuel inlet.

1-71. **HEAT EXCHANGER DESCRIPTION.**

1-72. The heat exchanger (figure 1-31) is within a basic envelope 43 inches in diameter and 58 inches in length, with the diameter varying from 40 inches at the turbine outlet to 24 inches at the turbine exhaust manifold. Hot gases from the turbine are directed to the heat exchanger where

a portion of the heat is transferred to the oxidizer and helium coils. In the heat transfer, oxidizer in the coils is converted to GOX for vehicle oxidizer tank pressurization, and the chilled helium in the coils is expanded for vehicle fuel tank pressurization. The upper section of the heat exchanger encloses the helium coils and mounting flanges for the helium and oxidizer supply and return lines. Each mounting flange is provided with ports to measure seal leakage. The supply ports incorporate orifices to control the flow of oxidizer or helium through the coils. The lower section of the heat exchanger encloses the oxidizer coils and contains a bellows assembly to compensate for thermal expansion during engine operation. Tubular structural members, clamped to the coils and welded to brackets incorporated in the heat exchanger body, secure and restrain the oxidizer coils. Heat exchanger connections at the turbine outlet manifold and the thrust chamber exhaust manifold are sealed by pressure-actuated Naflex seals.

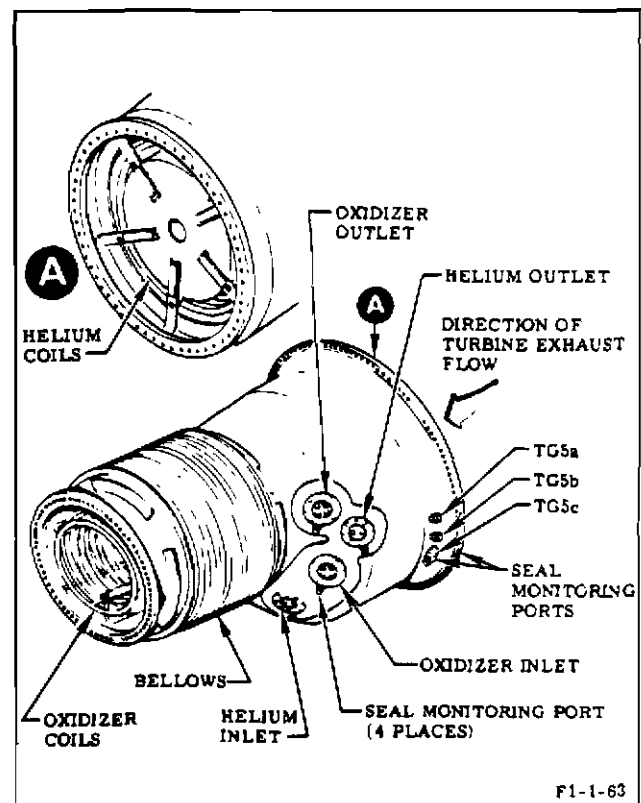

Figure 1-31. Heat Exchanger

1-73. ENGINE CONTROL SYSTEM DESCRIPTION.

1-74. The engine control system regulates the total engine operation. To provide this regulation, the engine control system directs, governs, and sequences the activity of engine propellant valves during the start, transition, mainstage, and cutoff phases of engine operation. Major components of the engine control system are the engine control valve, redundant shutdown valve, checkout valve, and hypergol manifold assembly. Orifices in the engine control system control propellant valves timing.

1-75. ENGINE CONTROL VALVE DESCRIPTION.

1-76. The engine control valve (figure 1-32) directs hydraulic fluid to open and close the propellant valves and the gas generator ball valve. The valve is electrically controlled and hydraulically actuated, with an internal hydraulic lockup that maintains actuation when the start signal is removed. The valve includes an override piston to deactuate the valve in case of stop solenoid failure. The assembly consists of a control section and a filter manifold section.

1-77. The control section consists of two solenoid-operated pilot (start and stop) valves, two slaved poppet valves, a matched selector spool and sleeve, a stop actuator, an override piston, and a valve body. The solenoid-operated pilot valves are identical except the start solenoid electrical connector has two pins and the stop solenoid has three pins to prevent improper connection. To ensure that the engine cannot be started with the stop solenoid disconnected, the negative lead of the start solenoid is wired in series with the negative lead of the stop solenoid. Each solenoid valve consists of a coil, a double-acting poppet (the armature), and two poppet seats (upstream and downstream). The

coil is energized by 24-30 vdc. The poppet is spring loaded against the downstream seat. Each solenoid valve is protected by a 10-micron filter at its inlet passage. A passage in the control valve body directs fluid to a passage that directs fluid to the poppet cavity. Two passages permit fluid flow from the cavity to the slaved pilot valve cylinder when the poppet is deenergized. The downstream seat forms the base of the valve assembly and contains a passage that is closed by the deenergized poppet and opened when the poppet is energized.

1-78. Two slaved pilot valves, each slaved to its respective solenoid pilot valve, direct fluid to shuttle the selector spool. Each slaved pilot valve consists of a poppet, two identical poppet seats, a piston, a cylinder, and a spring. The poppet is a pressure-actuated disc that free-floats between the two poppet seats. Both faces of the poppet are finished to provide a metal-to-metal seal with the poppet seats. The poppet seats, separated by a spacer, are installed face-to-face on both sides of the poppet. At start, momentary off-seating of the poppet from the normal position allows hydraulic pressure to shuttle the selector spool to open. The cylinder houses the piston and spring and is ported to admit hydraulic pressure to the spring cavity when the solenoid pilot valve is deenergized. When the start solenoid is energized, the piston is momentarily actuated through the force transmitted to the piston shaft by the poppet.

1-79. The selector valve is a matched spool and sleeve. The spool, floating inside the sleeve, is a hollow, closed-end cylinder with three ports and two sealing lands. The spool is actuated from its normal spring-loaded position (closed) by fluid pressure by the momentary actuation of the slaved pilot valve at start. Once actuated, the spool is hydraulically locked by fluid pressure from the open port. The sleeve

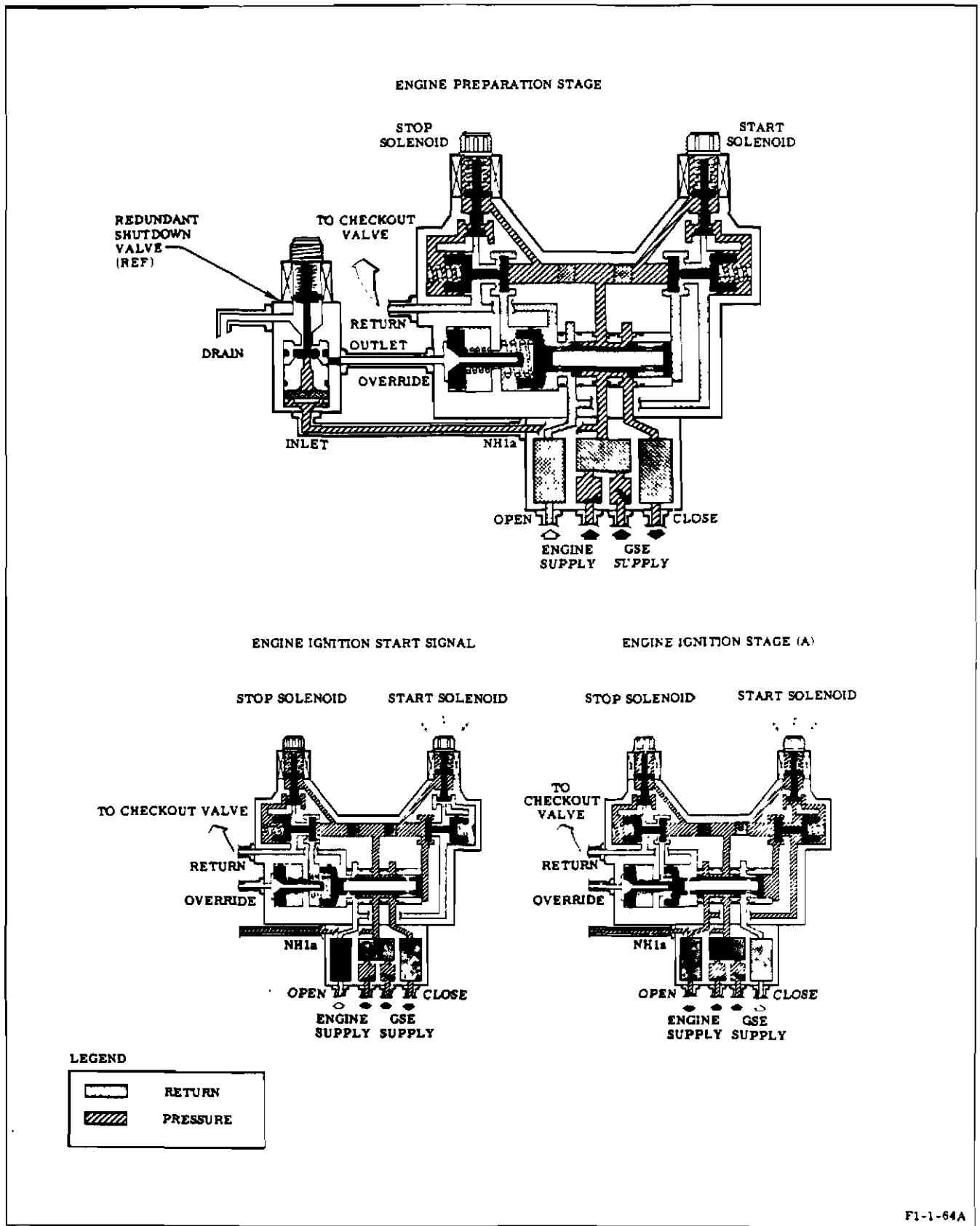
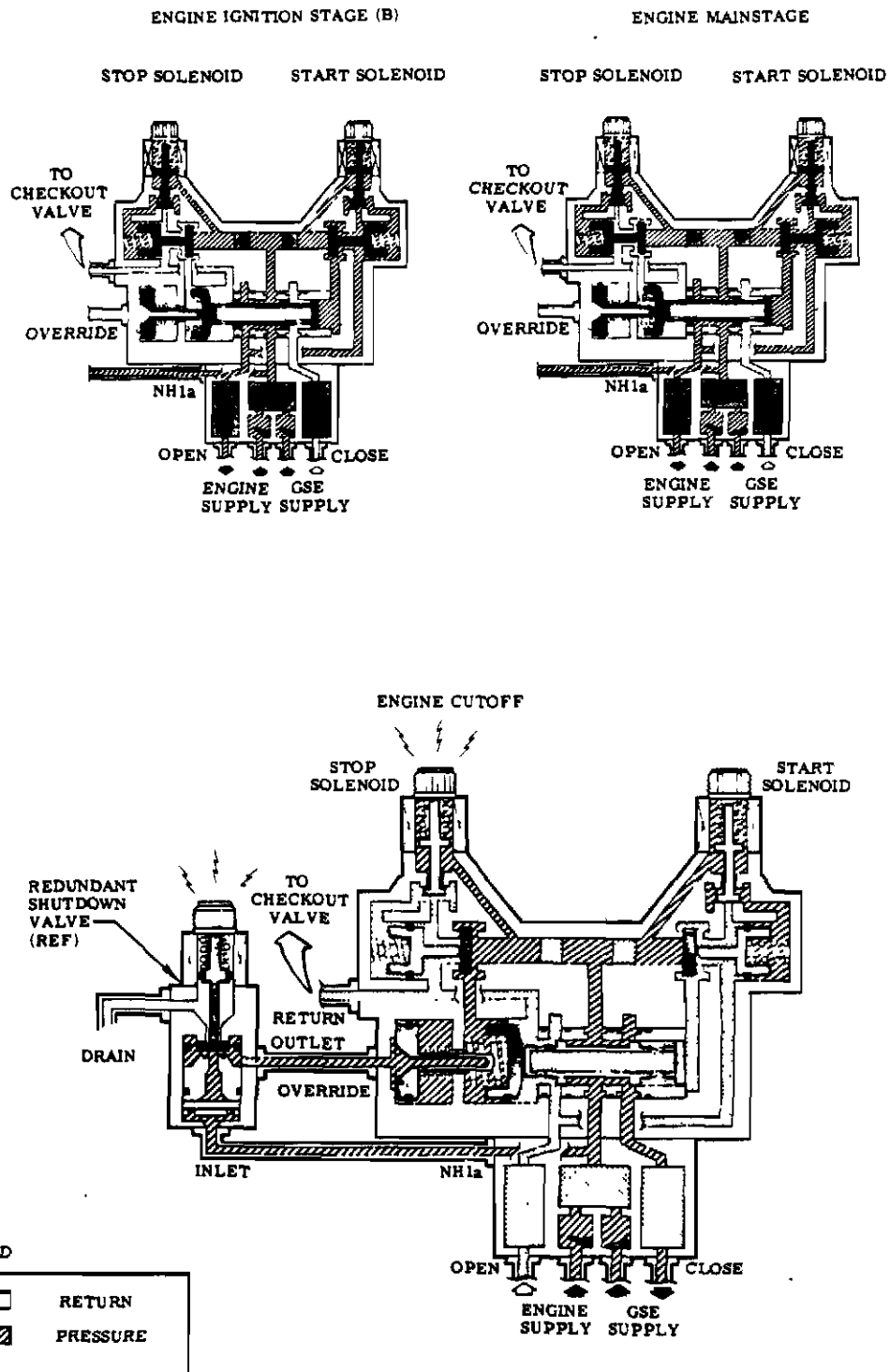

Figure 1-32. Engine Control Valve and Redundant Shutdown Valve Schematic (Sheet 1 of 2)



F1-1-66A

Figure 1-32. Engine Control Valve and Redundant Shutdown Valve Schematic (Sheet 2 of 2)

has three ports that align with three annular passages in the selector valve cavity. Four O-rings with Teflon backup rings prevent leakage between the annular passages. A threaded retaining cap holds the selector valve in its cavity and provides a mechanical stop for the spool.

1-80. The stop actuator is a spring-loaded, hydraulically actuated piston that positions the selector spool to the closed position. The actuator is normally controlled by the stop slaved pilot valve but can be directly actuated by the override piston in case of stop valve failure. Four holes admit control fluid into the spring cavity from an annular passage supplied from the stop slaved pilot valve. The override piston is hydraulically actuated and mechanically coupled to the stop actuator. The piston is used to position the selector spool in case of stop valve failure. An external pressure source is required to actuate the piston, which mechanically positions the selector spool to the closed position. The piston is held deactuated against a stop by a coil spring. The stop retains the override piston in its cavity and incorporates the override pressure inlet port. The control valve body houses the operational units and bolts to the filter manifold assembly. The interface of valve body and filter assembly is sealed by a seal plate.

1-81. The filter manifold is the supply filtration and distribution point for all control system fluid. The filter manifold consists of two swing-gate check valves, three filters, and a manifold body. The check valves are flange mounted back-to-back in a common supply cavity. One check valve covers the GSE SUPPLY fluid inlet port, and the other check valve covers the ENG SUPPLY fluid inlet port. Three 25-micron wire-mesh filters are installed in the manifold assembly. One filter is in the supply system and one each in the opening and closing passages. The manifold body houses the filters and is bolted to the control valve body. Two threaded ports in the ENGINE/GSE filter supply cavity provide pressure for instrumentation and for the emergency override system. Passages connect the closed, open, and supply filter cavities to corresponding ports of the control section. Three types of

seals are used in the engine control valve: Viton-A O-rings for plug and bleeder seals, a Viton-A Gask-O-Seal at the manifold-to-solenoid-valves joint, and Buna-N O-rings for all other applications.

1-82. REDUNDANT SHUTDOWN VALVE DESCRIPTION.

1-83. The redundant shutdown valve (figure 1-33) is a solenoid-operated, normally closed, three-way valve incorporating two 10-micron filters (one disk shaped, the other cylindrical), fixed inlet and vent seats, and a floating poppet that is spring loaded to the closed position against the inlet seat. The function of the valve is to direct hydraulic pressure to the engine control valve override pressure port as a redundant means of effecting engine shutdown in case of failure of the engine control valve stop solenoid, and to provide a drain for the override pressure port during engine checkout and operation. Continuous application of 24-30 vdc is required to keep the valve energized. The energizing signal input is applied simultaneously to the redundant shutdown valve solenoid and the engine control valve stop solenoid at engine cutoff. The redundant shutdown valve body provides an internal threaded DRAIN port and flanged IN and OUT ports. The solenoid electrical connector is a four-pin connector with only three of the pins used. Pin A is used for the positive energizing signal input, pin B for the negative return signal, and pin C for monitoring the signal received at the solenoid. Pins A and D are bussed internally within the connector. The seals used in the redundant shutdown valve are Buna-N O-rings.

1-84. CHECKOUT VALVE DESCRIPTION.

1-85. The checkout valve (figure 1-34) is within a basic envelope 8 by 9 by 14 inches and is located just below the engine control valve on the No. 2 side of the engine thrust chamber jacket. The checkout valve is a motor-driven selector valve that directs engine control return fluid back to the GSE or engine supply source. The checkout valve consists of a ball, a three-port housing, and an actuator. The actuator is a 24-30 vdc reversible motor that incorporates reduction gearing, position switches, and limit switches. The actuator controls the

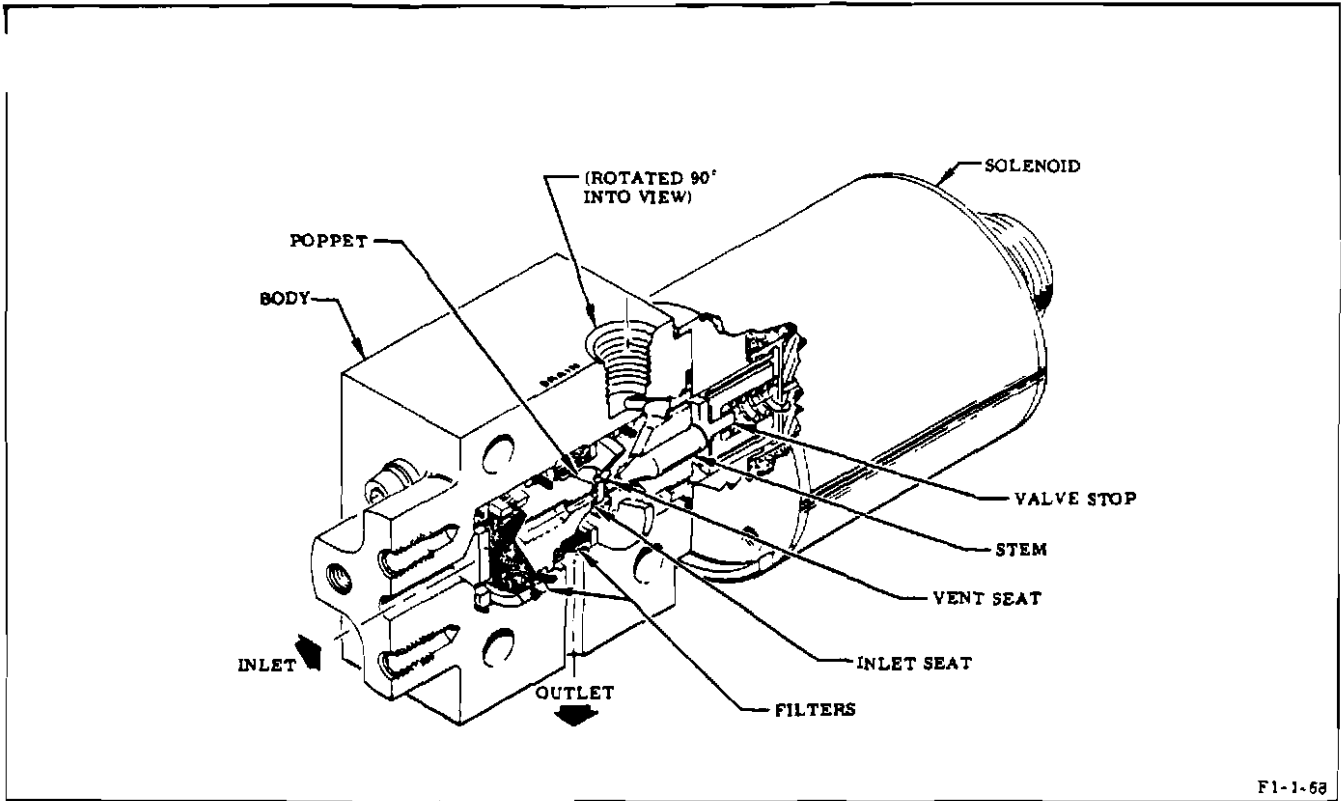

Figure 1-33. Redundant Shutdown Valve

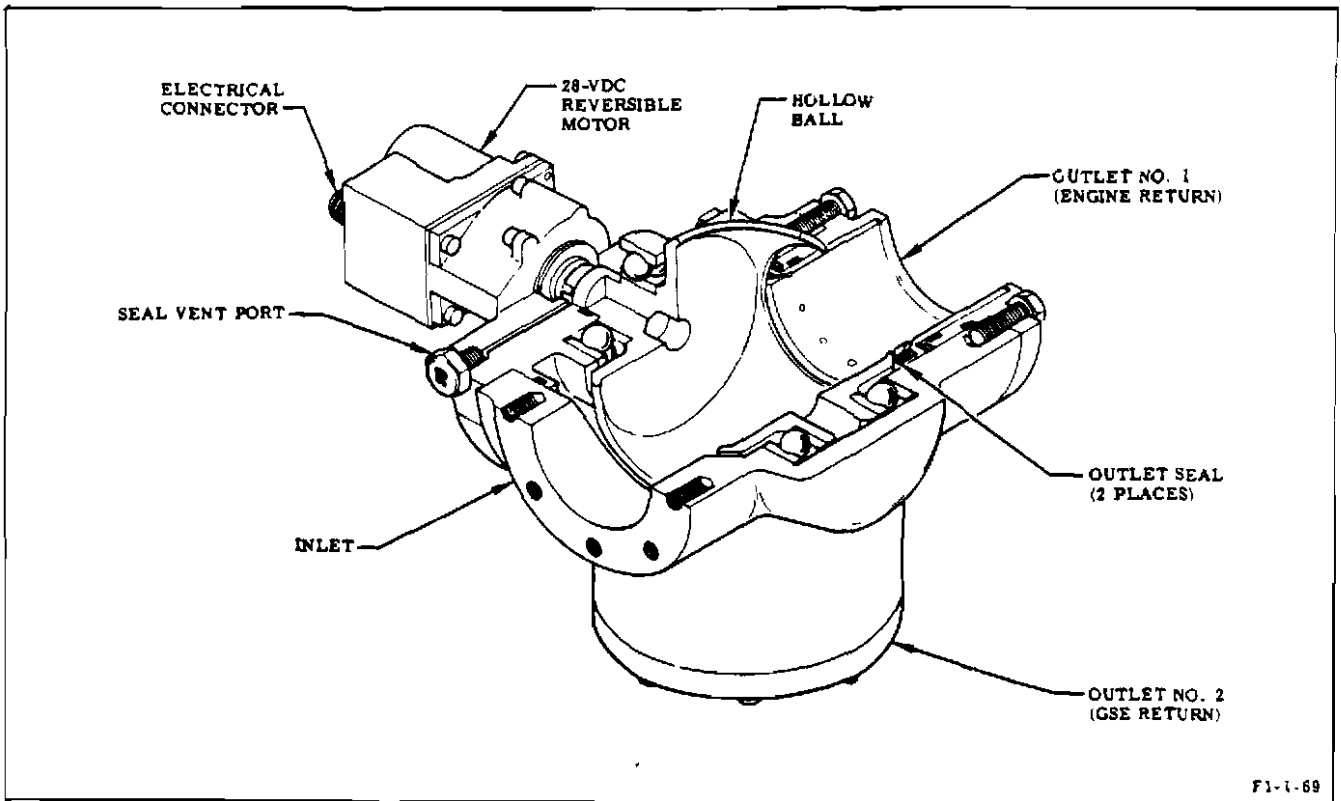

Figure 1-34. Checkout Valve

position of the ball to direct control fluid from the inlet port to one of the outlet ports. During engine checkout or servicing, the checkout valve ball is positioned so that fuel entering the inlet port is directed through the ball and out the GSE return outlet No. 2 port. For engine static firing or flight, the ball is positioned so that fuel entering the inlet port is directed through the ball and out the engine return outlet No. 1 port. Three types of seals are used in the checkout valve: Viton-A O-rings for dynamic applications, Buna-N O-rings for static applications, and machined Teflon seals for the ball seals.

1-86. HYPERGOL MANIFOLD ASSEMBLY DESCRIPTION.

1-87. The hypergol manifold assembly (figure 1-35) sequences engine operation from ignition stage into mainstage. The assembly is attached to a bracket located on the thrust chamber fuel manifold and consists of a hypergol cartridge container, an ignition monitor valve, an igniter fuel valve, and a hypergol installed switch. Only the hypergol cartridge container and hypergol installed switch are replaceable components of the assembly. The hypergol container is a cylindrical manifold into which the hypergol cartridge is installed. The hypergol installed switch is a cam-actuated switch that indicates the installed position of the hypergol cartridge. Hypergol manifold assembly leading particulars are listed in figure 1-36.

1-88. IGNITION MONITOR VALVE DESCRIPTION. The ignition monitor valve (figure 1-37) directs the opening of the fuel valves and permits the fuel valves to open only after satisfactory ignition has been achieved in the thrust chamber. The ignition monitor valve is a spring-loaded, pressure-actuated, fail-to-the-run, three-way valve mounted on the hypergol manifold and actuated by ignition combustion pressure. A dual-faced, spring-loaded poppet directs valve opening pressure to the fuel valves when ignition combustion pressure, acting on a laminated Mylar diaphragm, shuttles the poppet to the valve's open position. Once shuttled, the valve will remain in the open position until engine shutdown due to the differential pressure across the upstream and downstream faces of the poppets. Teflon Viton-A "slipper" seals and Buna-N O-rings

are used in dynamic and static seal applications. An internal orifice between the inlet and outlet ports permits fluid recirculation to bleed air from the control fluid. A mechanical lockup, actuated through a cam-rod that is positioned to cam the follower when an unruptured hypergol cartridge is installed, prevents ignition monitor valve actuation until the hypergol cartridge has ruptured. The atmospheric reference port is vented to the fuel overboard drain system.

1-89. IGNITER FUEL VALVE DESCRIPTION. The igniter fuel valve (figure 1-35) is an integral part of the hypergol manifold assembly. The igniter fuel valve is opened by fuel pressure applied to the FUEL INLET port of the hypergol manifold from the No. 1 fuel outlet duct. When the igniter fuel valve is opened, an internal passage in the manifold directs the fuel from the igniter fuel valve to the hypergol container where the fuel first ruptures the hypergol cartridge diaphragms and then follows the hypergolic fluid into the thrust chamber for ignition. A Teflon O-ring in the nose of the poppet seats against a seat machined into the hypergol manifold body. The desired spring loading is obtained by shimming the spring.

1-90. FLIGHT INSTRUMENTATION SYSTEM DESCRIPTION.

1-91. The flight instrumentation system monitors engine performance during checkout, test, and vehicle flight operations. The system consists of pressure transducers, temperature transducers, position indicators, a flow measuring device, power distribution junction boxes, and associated electrical harnesses. The basic flight instrumentation system is composed of a primary and an auxiliary system. The primary instrumentation system includes parameters critical to all engine static firings and subsequent vehicle launches, the auxiliary system is used during research, development, and acceptance test portions of the engine static-test program and initial vehicle flights.

1-92. Eight types of seals are used in the flight instrumentation system installation: asbestos rubber sheet gaskets for electrical connector application; Viton-A O-rings and Gask-O-Seals for fuel applications; copper crush washers, copper-plated nickel-base Naflex seals, and gold-plated steel K-seals for hot-gas applications; and Teflon-coated steel Naflex and K-seals for cryogenic applications. Refer to section II for detailed joint and seal data.

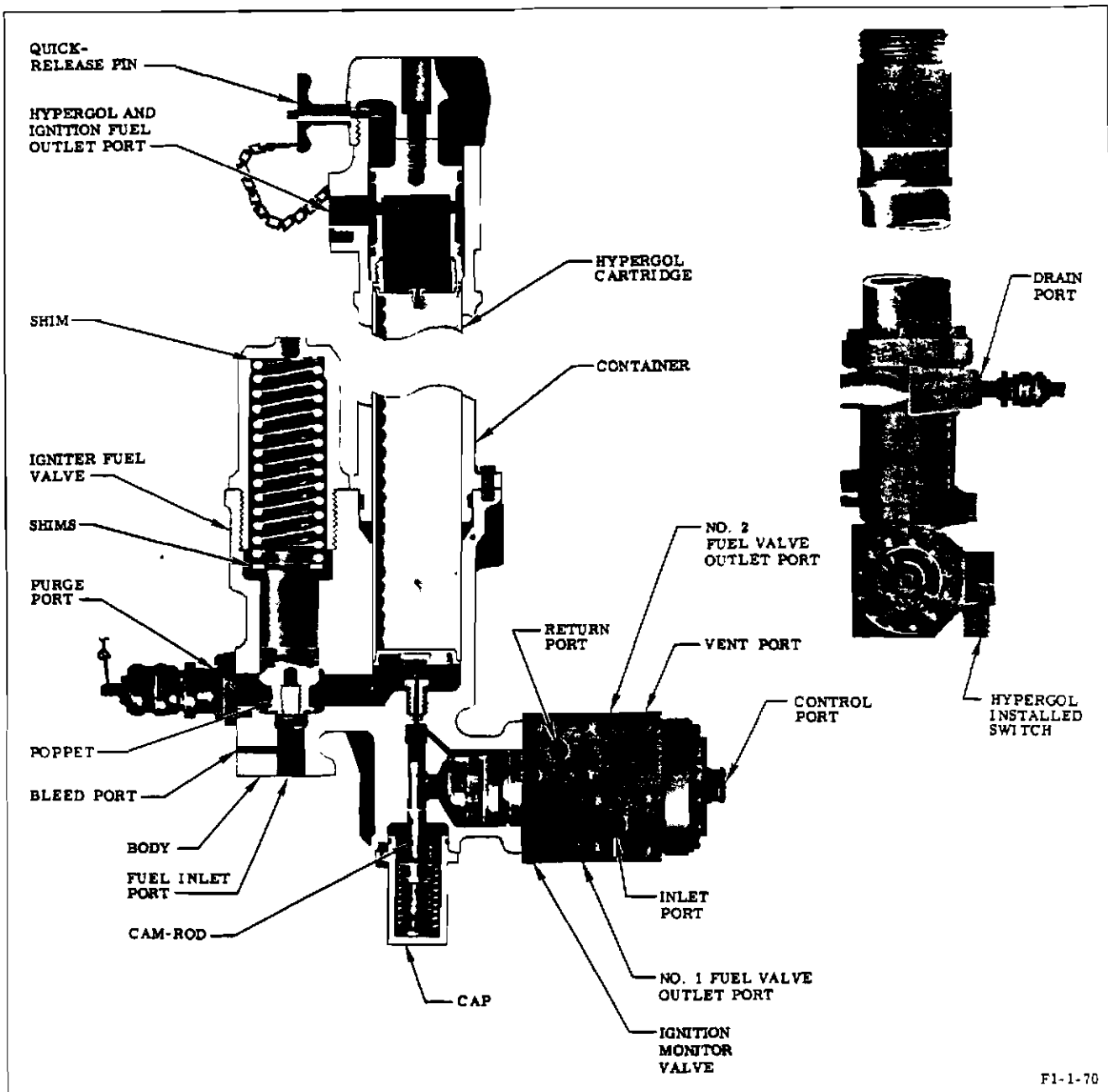

Figure 1-35. Hypergol Manifold

1-93. On engines incorporating MD96 change, transducers, harnesses, and related hardware that make up the auxiliary instrumentation system are removed, with the exception of the heat exchanger oxidizer inlet flowrate measurement transducer. The heat exchanger

oxidizer flowmeter and associated electrical harness are retained to maintain heat exchanger calibration capability. The flight instrumentation system parameters, including both the primary and auxiliary systems, are listed in figure 1-38.

IGNITER FUEL VALVE

Cracking pressure 375 \pm 30 psig
 Shimming effect Each shim changes the cracking pressure 4 psig.

IGNITION MONITOR VALVE

Actuating pressure 20 \pm 4 psig
 Recirculation flow 0.22 to 0.41 gpm

Figure 1-36. Hypergol Manifold Leading Particulars

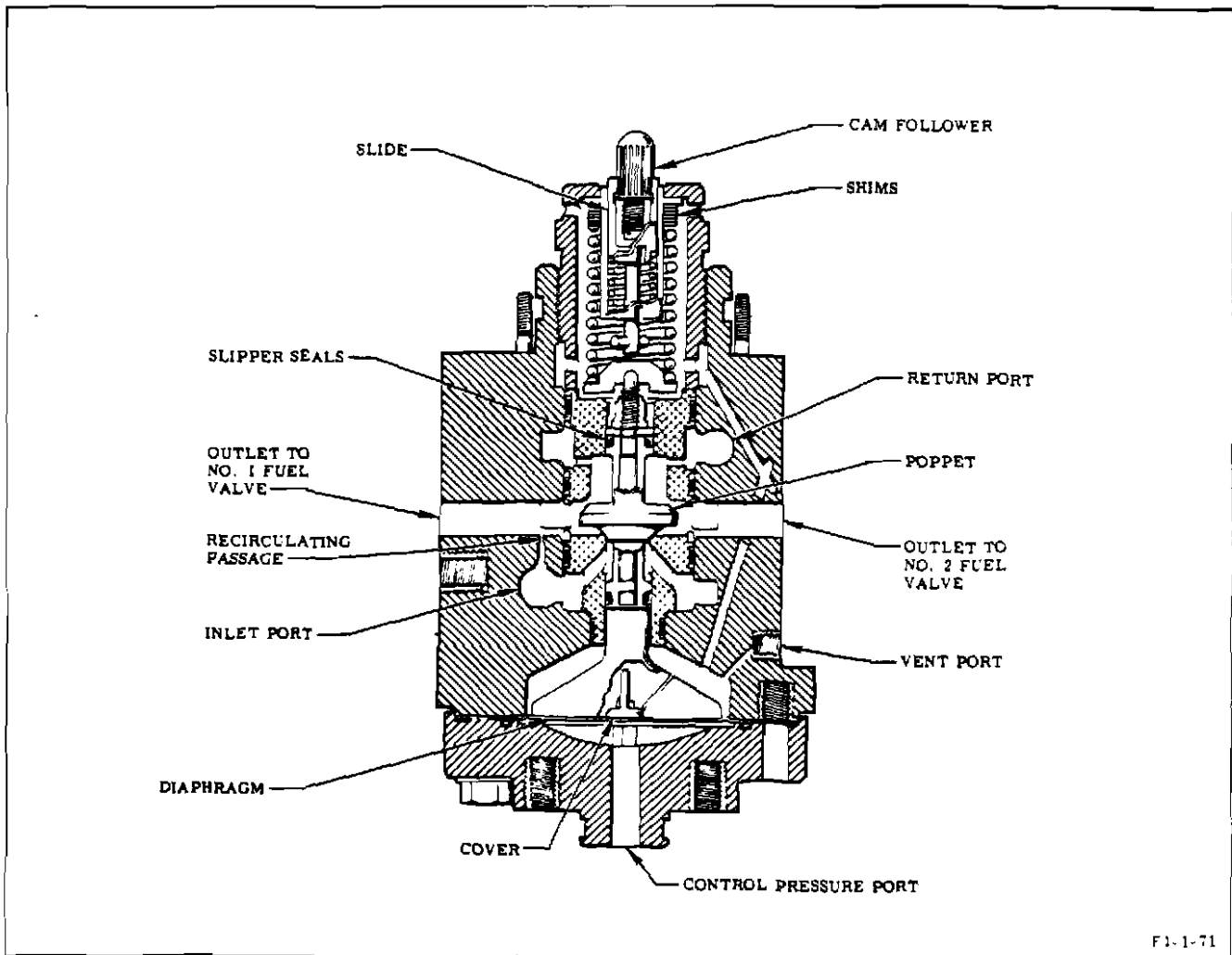

F1-1-71

Figure 1-37. Ignition Monitor Valve

| Tap No. | Parameter | Range | Accuracy (Percent) |
|--|---|------------------|--------------------|
| PRIMARY INSTRUMENTATION | | | |
| KF6a-1 | Fuel pump inlet No. 1 pressure | 0-200 psia | 2.0 |
| TG5c | Turbine outlet pressure | 0-100 psia | 2.0 |
| PF2a-2 | Fuel pump discharge No. 2 pressure | 0-2,500 psia | 2.0 |
| CG1e | Combustion chamber pressure | 0-1,500 psia | 0.5 |
| GG1d | Gas generator chamber pressure | 0-1,500 psia | 1.0 |
| PO2a-2 | Oxidizer pump discharge No. 2 pressure | 0-2,000 psia | 2.0 |
| NH5c | Common hydraulic return pressure | 0-500 psia | 2.0 |
| LB1a | Oxidizer pump bearing jet pressure | 0-1,000 psia | 2.0 |
| LS1 | Oxidizer pump bearing No. 1 temperature | 0° to 400° F | 2.0 |
| TG4a(a) | Turbine inlet manifold temperature | 0° to 2,000° F | 2.0 |
| CGT1 | Engine environmental temperature | 0° to 1,500° F | 2.0 |
| F44 | Heat exchanger oxidizer inlet flow | 20-100 gpm | 2.0 |
| AUXILIARY INSTRUMENTATION^(b) | | | |
| PO7a | Oxidizer pump seal cavity pressure | 0-50 psia | 2.0 |
| HH2a | Heat exchanger helium inlet pressure | 0-500 psia | 2.0 |
| HH3a | Heat exchanger helium outlet pressure | 0-500 psia | 2.0 |
| PO2a-1 | Oxidizer pump discharge No. 1 pressure | 0-2,000 psia | 2.0 |
| HO1b | Heat exchanger oxidizer inlet pressure | 0-2,000 psia | 2.0 |
| HO4a | Heat exchanger GOX outlet pressure | 0-2,000 psia | 2.0 |
| PF2a-1 | Fuel pump discharge No. 1 pressure | 0-2,500 psia | 2.0 |
| NH3a | Engine control opening pressure | 0-2,500 psia | 2.0 |
| NH2a | Engine control closing pressure | 0-2,500 psia | 2.0 |
| HO1a | Heat exchanger oxidizer inlet temperature | -300° to -250° F | 2.0 |
| HO4b | Heat exchanger GOX outlet temperature | -300° to +600° F | 2.0 |
| F16 | Heat exchanger oxidizer inlet flow ^(c) | 0-100 gpm | 2.0 |

(a) Engines not incorporating MD176 change

(b) Engines not incorporating MD96 change

(c) On engines incorporating MD96 change, this measurement is retained and relocated to primary system as tap number F44.

Figure 1-38. Flight Instrumentation System Parameters

1-94. PRIMARY AND AUXILIARY JUNCTION BOX DESCRIPTION.

1-95. There are two electrical junction boxes in the flight instrumentation system: the primary junction box located in the primary system and the auxiliary junction box located in the auxiliary system. On engine incorporating MD96 change, the auxiliary junction box is deleted. The junction boxes serve as junction points for signal circuitry of respective

transducers either to and from the telemetry and instrumentation system during vehicle flight or to and from the control center during engine static test. The primary junction box (figure 1-39) has provisions for eight electrical connections; the auxiliary junction box (figure 1-40) has provisions for five electrical connections. Both junction boxes are hermetically sealed to prevent possible entry of contaminants and moisture.

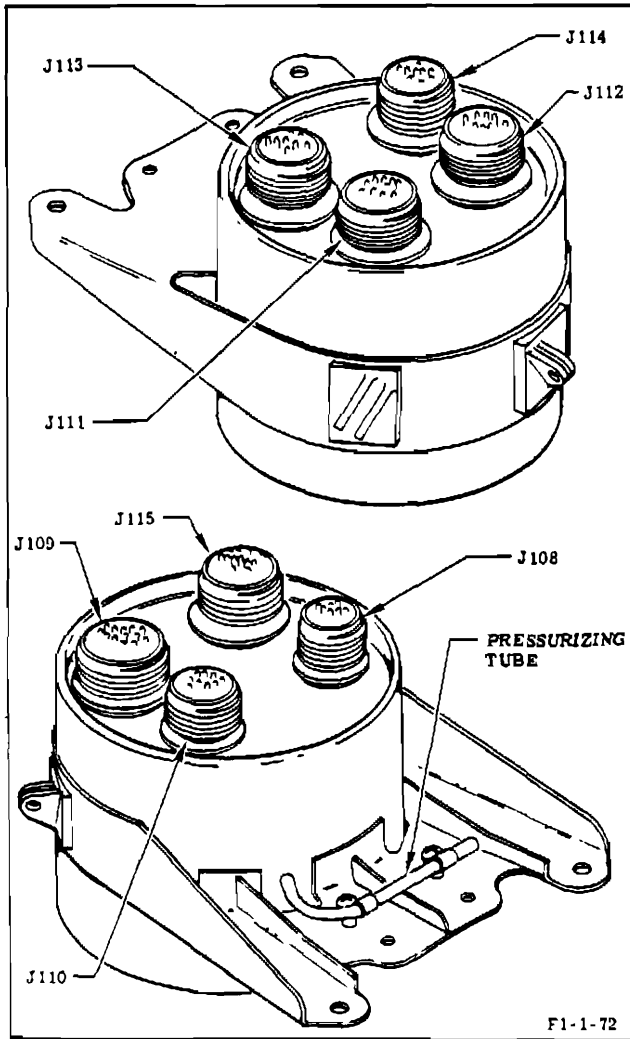

Figure 1-39. Primary Junction Box

1-96. PRESSURE TRANSDUCER DESCRIPTION.

1-97. The flight instrumentation transducer (figure 1-41) is a dc input, dc output, absolute pressure transducer consisting of a mechanical-force summing element coupled to an electrical bridge. The output of the electrical bridge is directly proportional to the pressure applied to the mechanical-force summing network. All four of the bridge elements in the transducer are active. For each bridge element that increases impedance with increasing pressure, a second bridge element decreases impedance

with increasing pressure. These elements are connected into the bridge in such a way as to obtain maximum sensitivity from the bridge. The transducer also contains the necessary circuit elements to isolate the output from the input, to provide a regulated bridge excitation voltage, to provide all necessary bridge amplification, to provide bridge output demodulation if required, and to provide all required output filtration so that the transducer can be excited with a nominal 28-vdc input and provide a 5-vdc output at full pressure range. The transducer features the capability of simulating the output at 20 and 80 percent of its operating range. These simulation steps are activated by applying 28 vdc to pins E and F for the 20- and 80-percent points, respectively. The application of this voltage activates a switching circuit

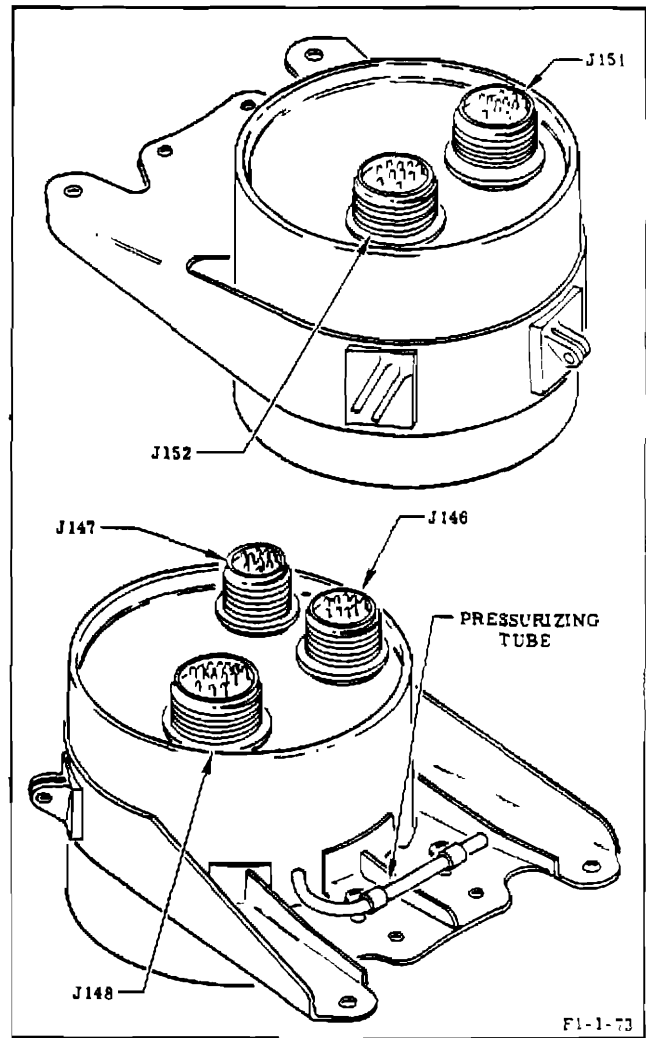

Figure 1-40. Auxiliary Junction Box

Change No. 7 - 18 August 1969

1-39

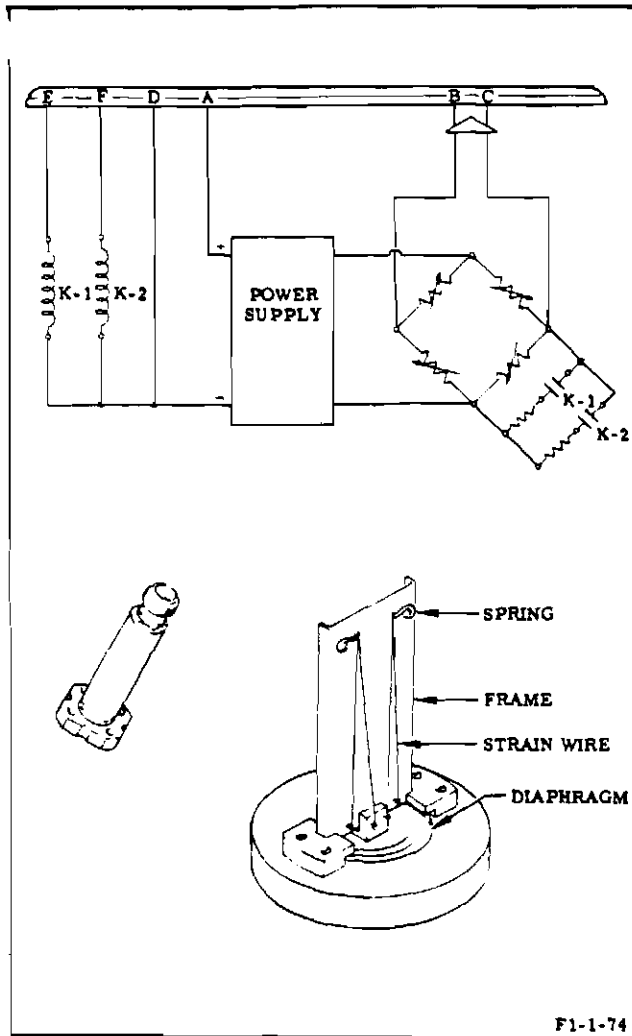

Figure 1-41. Pressure Transducer

that substitutes a resistor in the bridge network, thereby simulating the bridge output for 20 or 80 percent of the pressure range of the instrument. The transducer uses a six-pin connector with the following pin functions:

- a. Pin A, positive excitation (+28 vdc)
- b. Pin B, positive output (+5 vdc at full range pressure)
- c. Pin C, output return
- d. Pin D, excitation return

e. Pin E, 20-percent calibration (+28 vdc)

f. Pin F, 80-percent calibration (+28 vdc)

1-98. TEMPERATURE TRANSDUCER DESCRIPTION.

1-99. The flight instrumentation temperature transducers (figure 1-42) are of the platinum resistance type. All of the resistance bulbs have a three-wire termination that allows a bridge completion with a transmission line in opposite legs of the bridge, thereby making zero and sensitivity changes negligible with respect to variations in line length and resistance. Each transducer is supplied with its own resistance-versus-temperature calibration over a specified range. While all of the transducers operate on the same principle and the electrical connections are identical, the physical configurations of the various transducers differ with the installation and measurement requirements. Engines incorporating MD159 change have an improved cocoon temperature transducer with glass-insulated and resistance-welded lead wires enclosed in a platinum tube and a sensing element protected by a shield.

1-100. OXIDIZER FLOWMETER DESCRIPTION.

1-101. The oxidizer flowmeter (figure 1-43) is a turbine-type, volumetric, liquid-flow transducer mounted between the heat exchanger check valve and the oxidizer inlet line to measure the flow of oxidizer entering the heat exchanger coil. The flowmeter consists of a rotor assembly that senses the oxidizer flow, flow straighteners that direct the flow of oxidizer across the rotor, and two pickup coils. The pickup coils are enclosed, moistureproof units with electrical receptacles. Each coil is electrostatically shielded and potted and contains an auxiliary isolated coil for checkout purposes. The flow of oxidizer through the flowmeter sets the rotor in motion. The angular speed of the rotor is a function of the volumetric flowrate of the oxidizer and is detected by the magnetic pickup that the flux

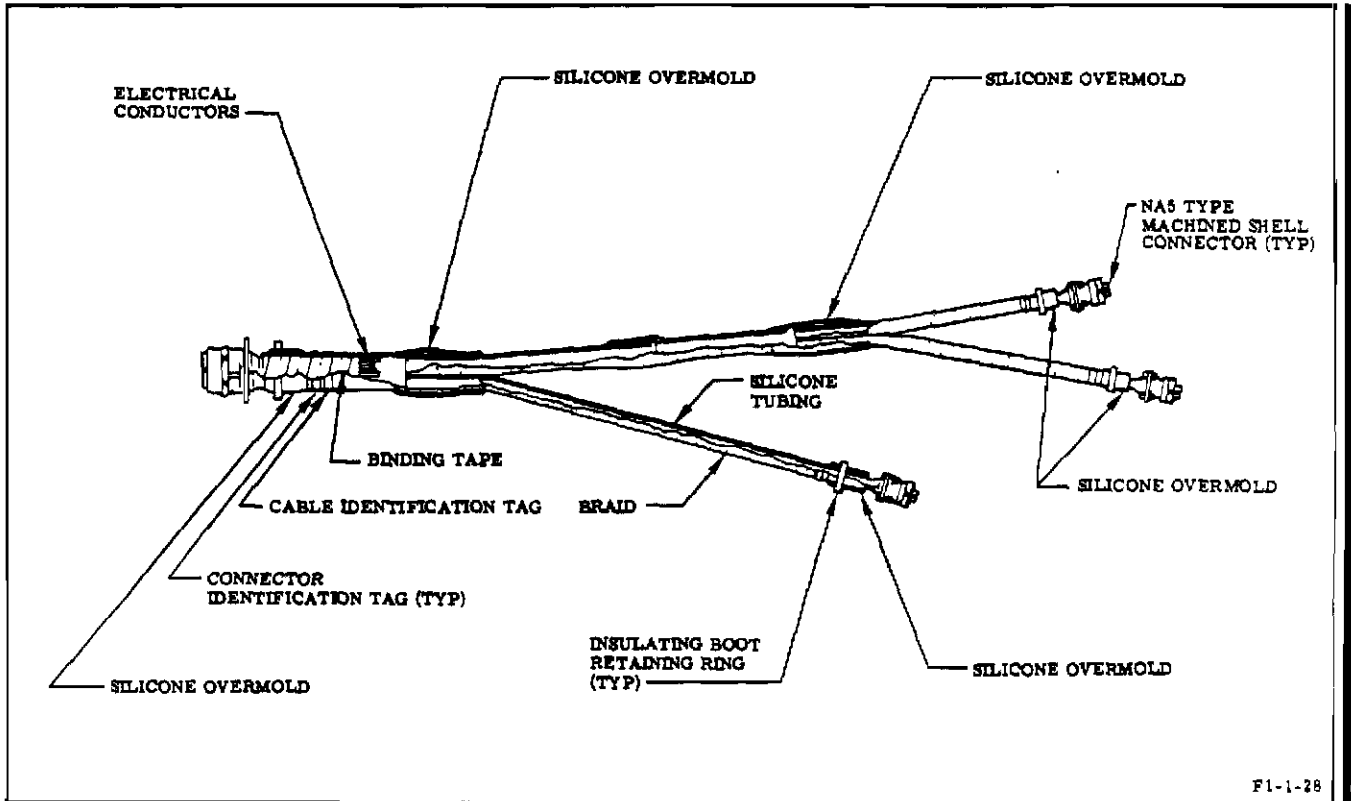
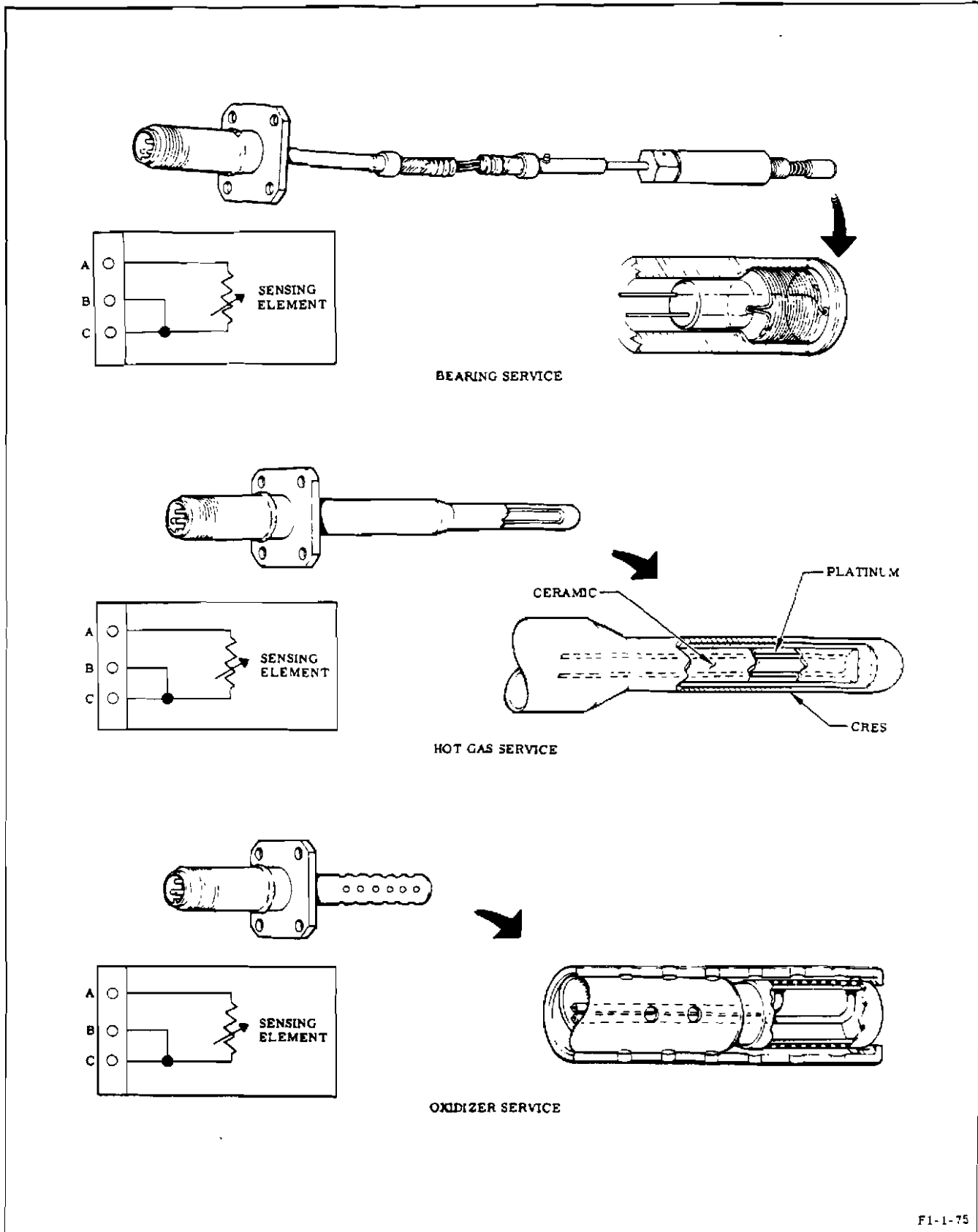

Figure 1-36. Flexible Armored Harness (Typical)--Cutaway View



F1-1-75

Figure 1-42. Temperature Transducers

Change No. 7 - 18 August 1969

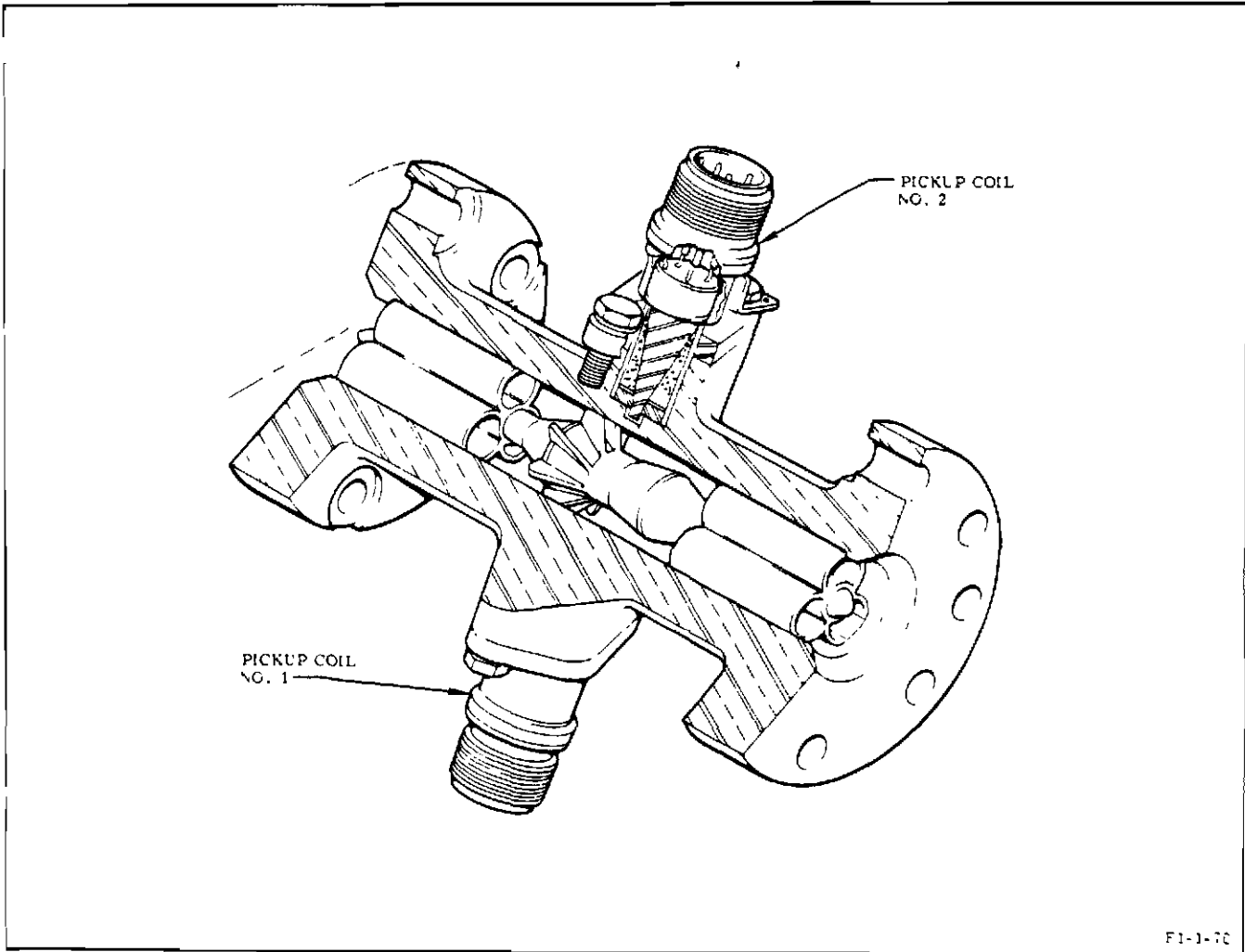

Figure 1-43. Oxidizer Flowmeter

density through the coil changes. The flux lines through the coil build up and collapse, generating an emf that can be measured at the connector. The magnitude of this emf is a function of the angular speed of the rotor, distance of the pickup from the top of the blades, and the blade material (a constant). The generated frequency is dependent on rotor speed and number of blades and is in direct correlation to flow-rate. For checkout purposes, a sinusoidal input at 200 cps with a 10-volt peak on the auxiliary coil will produce a 1-3 volt peak signal at the same frequency on the primary or output coil.

1-102. SPEED TRANSDUCER DESCRIPTION.

1-103. The flight instrumentation system utilizes one speed transducer (figure 1-44). The transducer is a magnetic pickup type used to sense turbopump speed. The assembly consists of a probe section that houses the pickup coils, an adapter section (welded between the probe and electrical receptacle) that is threaded to allow installation of the unit into the torque gear housing of the turbopump, an electrical receptacle, and a pickup coil that serves as a

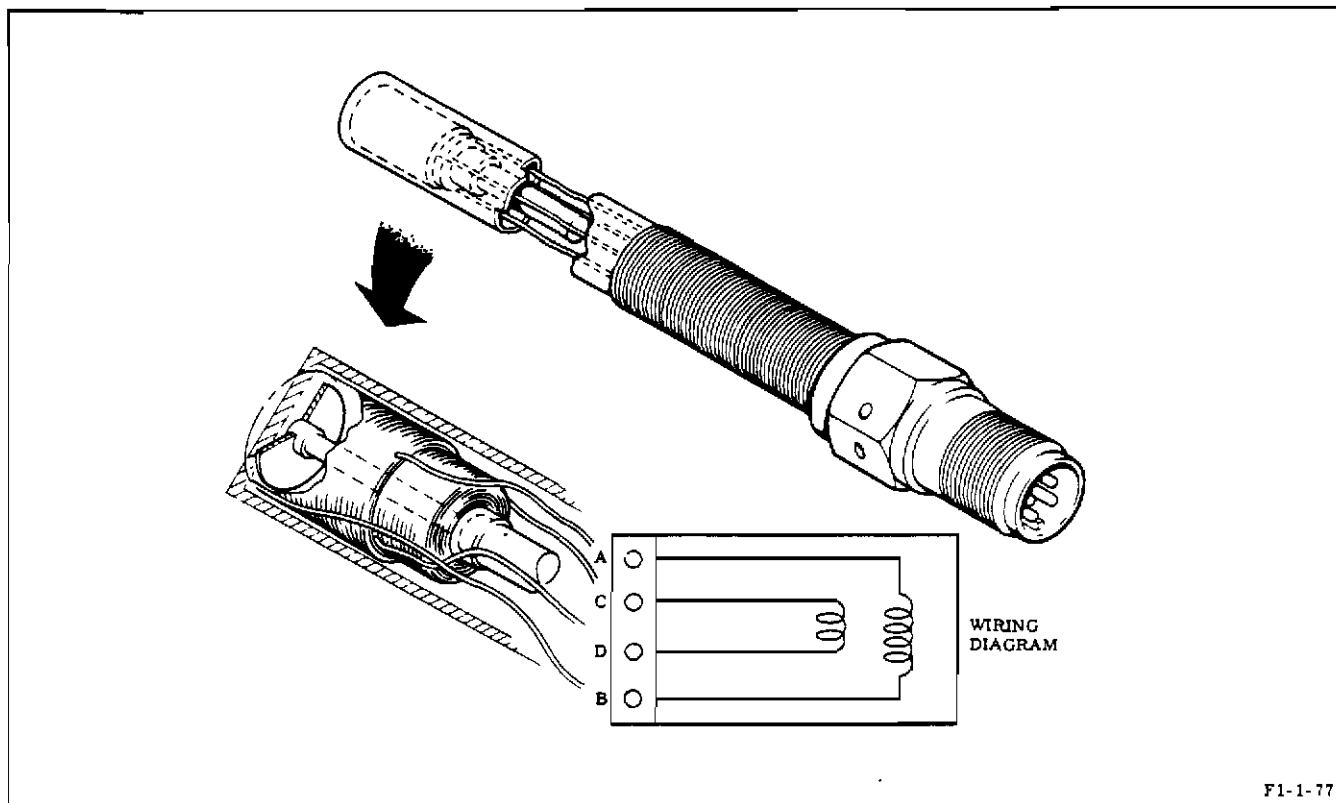

Figure 1-44. Speed Transducer

pulse generator. With the transducer installed, the tip of the probe aligns with the two-hole tachometer on the turbopump torque gear sleeve. As the turbopump shaft rotates and each hole passes the tip of the probe, the flux density of the pickup coil is interrupted. The buildup and collapse of the flux lines generate a voltage across the leads. This voltage, proportional to the pump shaft speed, is then conditioned for recording. The magnitude of the voltage is dependent on the angular speed of the turbopump shaft, the distance between the pickup coil and torque gear sleeve, and the medium of the gap. The frequency is determined by the angular speed of the pump shaft, and the number of holes in the torque gear sleeve.

1-104. THERMAL INSULATION SYSTEM DESCRIPTION.

1-105. Thermal insulation (figure 1-45) is supplied to protect the engine from extreme temperature environment caused by plume radiation and

back-flow during vehicle flight. Thermal insulators for the engine are of two types, foil-batt and asbestos blanket.

1-106. Foil-batt insulators are preformed segments constructed of random fiber batting secured between two layers of textured inconel foil. The thickness of the thrust chamber insulator inner foil is 0.004 inch; outer foil thickness is 0.006 inch. Cocoon insulator foils are 0.006 inch thick. The cocoon insulator inner foil is vented to prevent ballooning due to expansion of gases trapped between the layers of foil. These insulators are used to cover large, flat areas of the thrust chamber and nozzle extension, heat exchanger lines and bellows, customer connect (wrap-around) lines, and the cocoon area (thrust chamber throat to interface panel).

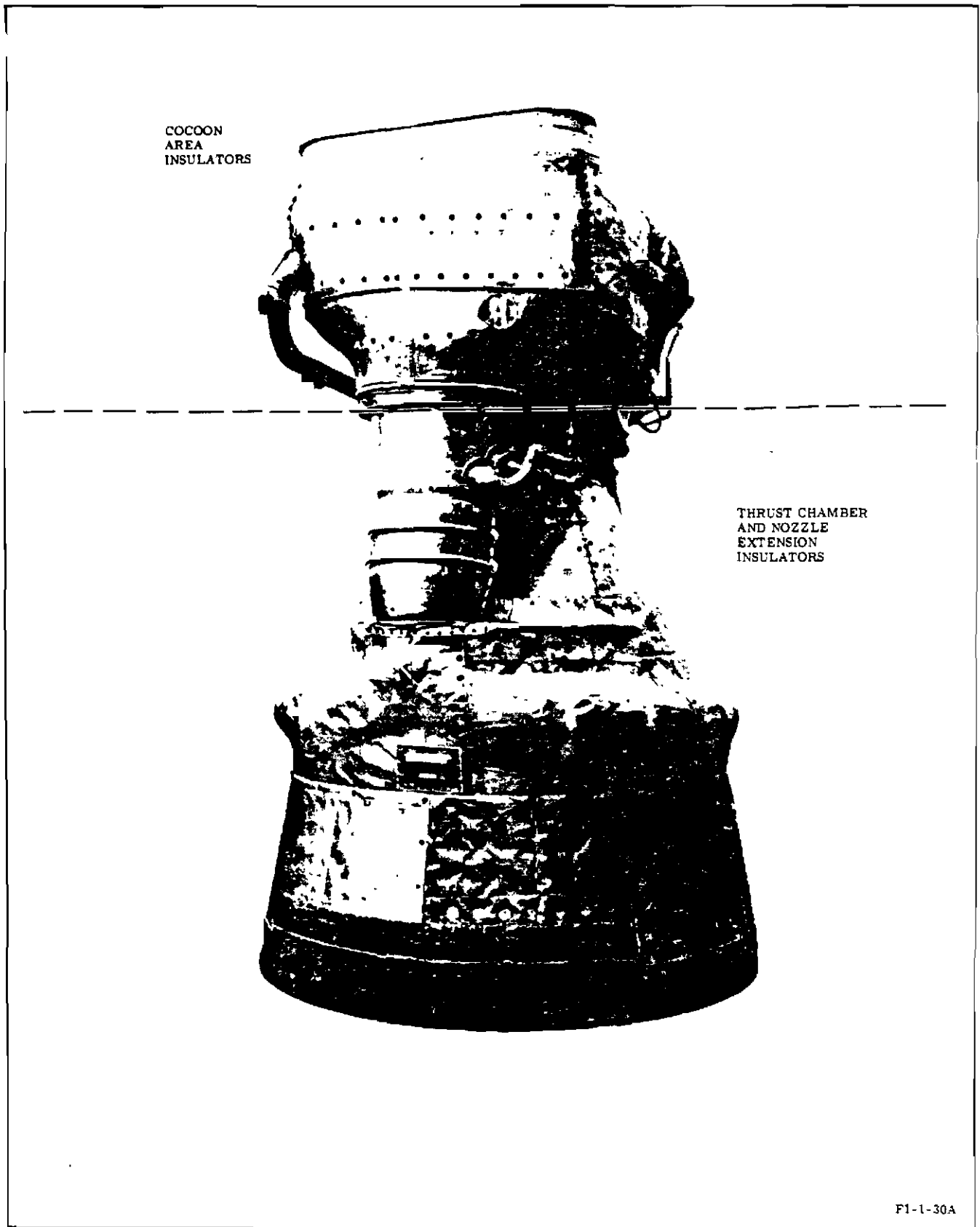

F1-1-30A

Figure 1-45. Engine Thermal Insulation

1-107. Asbestos blanket insulators are composed of multiple layers of asbestos cloth reinforced with Inconel lockwire and coated on one side with aluminum. The asbestos blankets are laminates of two, four, or five layers, depending on the location on the engine. Asbestos blankets are used on the exit end of the nozzle extension, above the oxidizer dome between the gimbal bearing and interface panel, and below the cocoon between the thrust chamber and turbine manifold.

1-108. Hardware used to secure the thermal insulation to the engine consists of support structure, screws, self-locking nuts, flat washers, nut clips, bolts, and Inconel lockwire. Support structure (brackets, straps, and supports) is located primarily in the cocoon area. Protruding studs are percussion-welded onto hatbands of the thrust chamber to support and secure insulator panels. Brackets with nutplates are provided to secure insulator panels to the nozzle extension.

1-109. ENGINE PURGE AND DRAIN SYSTEM DESCRIPTION.

1-110. The engine purge and drain system (figure 1-46) provides a means of inhibiting contamination in the critical areas of the engine and permits safe disposition of expended coolant fluids, residual propellants, and seal leakage fluids. The engine purge system and the drain system are each divided into a service mode system and an operational mode system.

1-111. SERVICE MODE PURGE SYSTEM DESCRIPTION.

1-112. The service mode purge system utilizes facility-supplied gaseous nitrogen to expel residual propellants and fluids from the engine. The service mode purge system consists of quick-disconnect fittings on the No. 1 and No. 2 fuel valves for supplying gaseous nitrogen to the fuel valves and thrust chamber, one quick-disconnect on the hypergol manifold assembly to purge the hypergol container and ignition fuel hose of residual fluids, a quick-disconnect on the ignition monitor valve sense tube to purge the tube of residual fluid, a quick-disconnect at

the bearing coolant control valve to purge the bearing coolant delivery lines of residual coolant fluid and preservative compound, and six threaded bosses on the oxidizer dome to purge the oxidizer dome and injector of residual flushing fluid.

1-113. OPERATIONAL MODE PURGE SYSTEM DESCRIPTION.

1-114. The operational mode purge system utilizes vehicle- and facility-supplied gaseous nitrogen to establish a pressure barrier to protect the oxidizer sections of the engine from contamination. The gaseous nitrogen is supplied to the engine through two purge fittings. One of the purge fittings provides gaseous nitrogen from the vehicle at 80 psig for purging the oxidizer pump intermediate seal. The other purge fitting directs gaseous nitrogen at 800 psig to the gas generator and No. 1 and No. 2 oxidizer valves to prevent contaminants from entering the oxidizer sections of the gas generator and thrust chamber during ignition and transition into mainstage.

1-115. SERVICE MODE DRAIN SYSTEM DESCRIPTION.

1-116. The service mode drain system enables residual fuel and control system fluid to be drained from the engine during maintenance and post-test securing of the engine. The service mode drain system consists of quick-disconnect fittings and drain plugs located at low points of the propellant feed and control systems. The quick-disconnect fittings utilized for draining residual fuel are located on the No. 1 and No. 2 fuel inlet elbows, No. 1 and No. 2 high-pressure fuel ducts, thrust chamber fuel inlet manifold, hypergol manifold, and gas generator. Quick-disconnect fittings for draining the control system fluid are located on the control system engine return line, control system engine supply line, and gimbal actuator return line. Four drain plugs located on the thrust chamber fuel return manifold permit the thrust chamber tubes to be drained of residual fuel, prefill fluid, or flushing solvent.

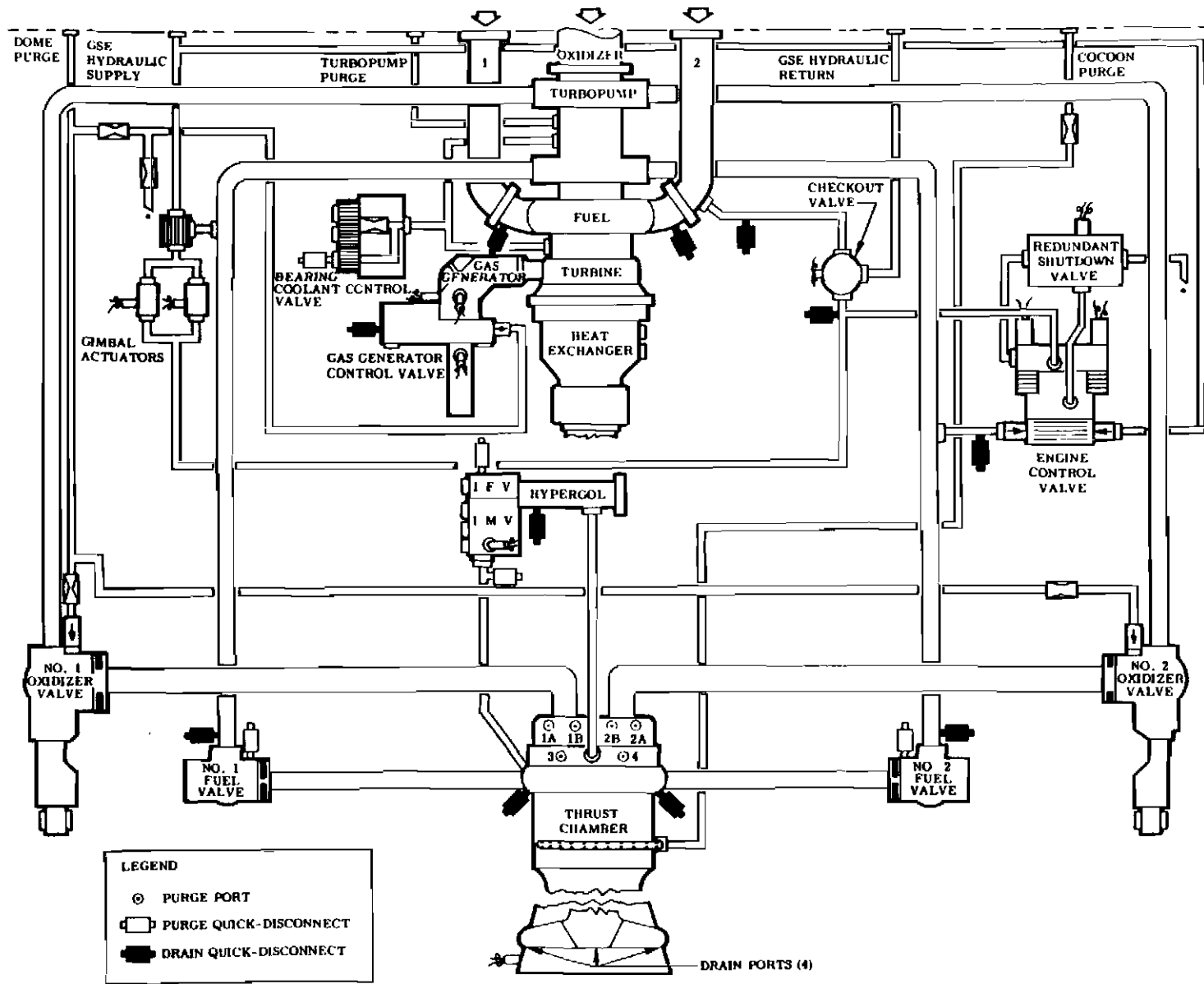

Figure 1-46. Engine Purge and Drain Schematic

1-117. OPERATIONAL MODE DRAIN SYSTEM DESCRIPTION.

1-118. The operational mode drain system furnishes a means of overboard disposition of fluid leakage past internal seals of certain components, and of expended bearing coolant fluid from the turbopump. The operational mode drain system consists of separate oxidizer and fuel overboard drain lines and a fuel drain manifold. Fuel and control fluid seal leakage and expended coolant fluid are collected into a single fuel overboard drain line on the No. 2 side of the engine. (See figures 1-47 and 1-47A.) The fuel drain manifold (figure 1-48) is the collective drain point for the expended coolant fluid and excess preservative compound remaining during turbopump preservative procedures. Oxidizer leakage past the primary oxidizer seal of the turbopump and the internal oxidizer seals of the No. 1 and No. 2 oxidizer valves and gas generator control valve are directed to an oxidizer overboard drain line on the No. 1 side of the engine. (See figure 1-49.) This line also directs overboard the purge flow through the oxidizer side of the turbopump intermediate seal. Paralleling the oxidizer overboard drain line on the No. 1 side of the engine is the nitrogen purge overboard drain line, which directs overboard the purge flow through the fuel side of the intermediate seal.

1-119. ENGINE OPERATIONAL REQUIREMENTS.

1-120. The engine requires a source of pneumatic pressure, electrical power, and propellants for engine operation. A ground-supplied hydraulic pressure source, hypergolic fluid, prefill fluid, and pyrotechnic igniters are required for engine start. Figure 1-50 lists facility-supplied inputs required for engine operation.

1-121. ENGINE OPERATION.

1-122. Engine operation is described within this section in terms of engine preparation stage, engine start and ignition, engine mainstage, and engine cutoff for a typical single engine in a test facility. This description is supplemented by an engine start and an engine cutoff block diagram flow chart (figures 1-51 and 1-52), an engine system schematic reflecting engine conditions during the respective stages of operation (figures 1-53, 1-54, 1-55, and 1-56), and engine start and cutoff sequence flow charts (figures 1-57 and 1-58). The sequence of engine start and shutdown is controlled by an electrical-hydraulic-mechanical system. Electrically, relays in the facility equipment, and solenoids and switches on the engine, are employed to start, maintain, and stop the sequence. An orificed hydraulic control system powers and sequences the propellant and control valves. Also, mechanically linked devices assist in sequencing propellant valve actuation.

1-123. ENGINE PREPARATION STAGE.

1-124. The engine preparation stage is that activity during which it is determined that the engine and the test facility are in a satisfactory condition for a safe engine start. The culmination of this activity is an ENGINE PREPARATION COMPLETE signal which, in conjunction with a facility preparation complete signal, makes electrical power available to the engine start switch.

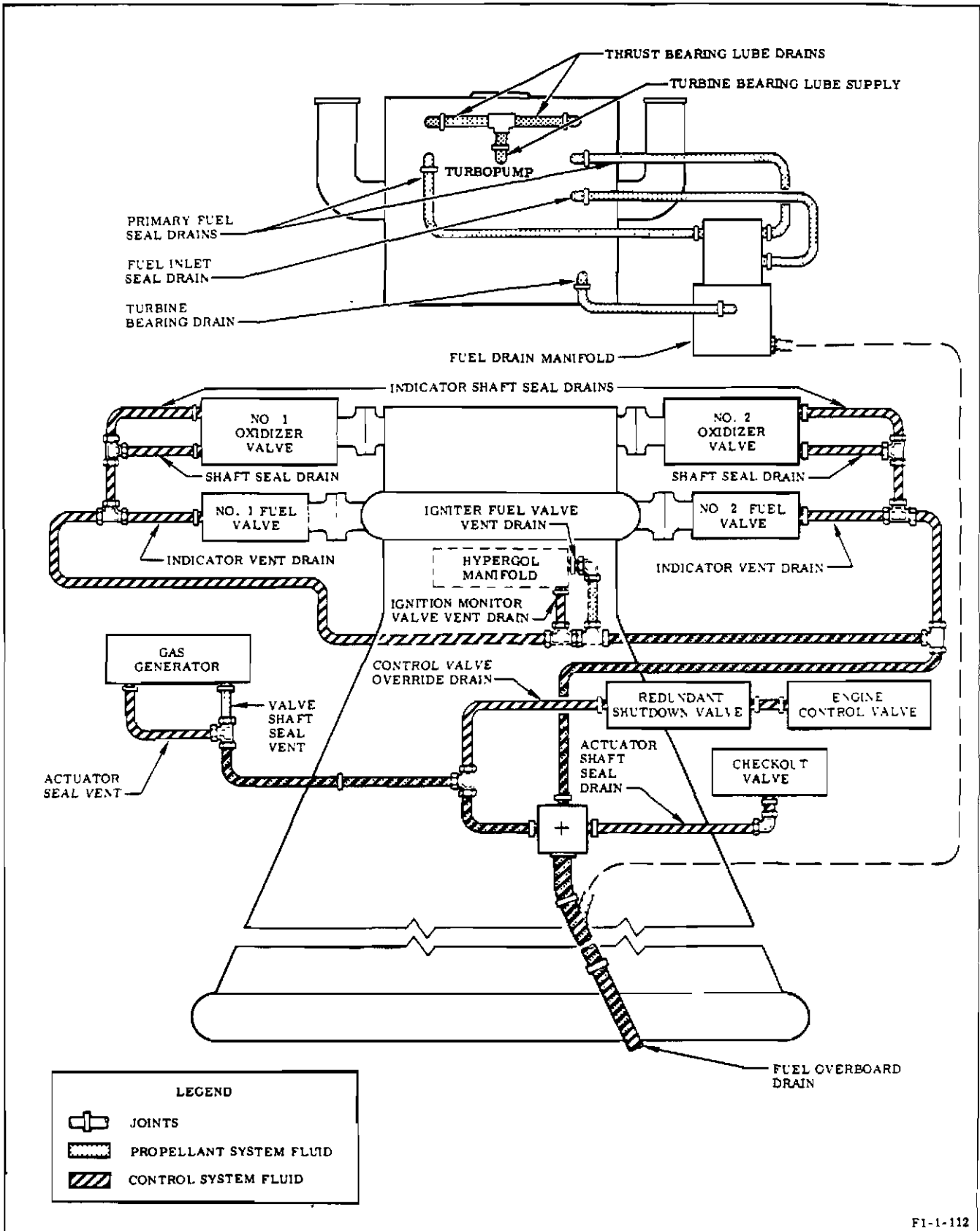

F1-1-112

Figure 1-47A. Engine Fuel and Control Fluid Overboard Drain Schematic (Engines Incorporating MD145 Change)

Change No. 9 - 4 November 1970

1-48A/1-48B

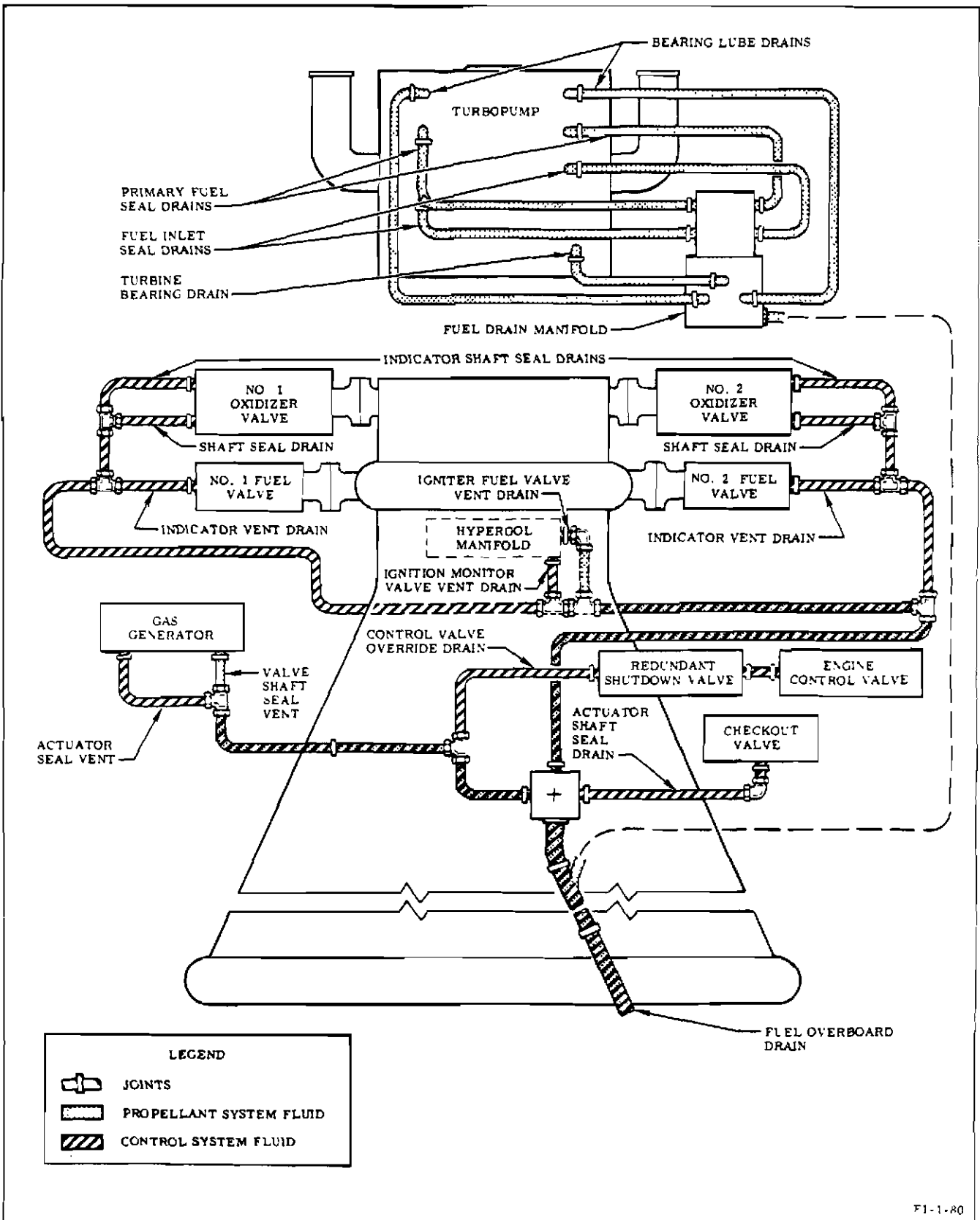

Figure 1-47. Engine Fuel and Control Fluid Overboard Drain Schematic (Engines No. Incorporating MD145 Change)

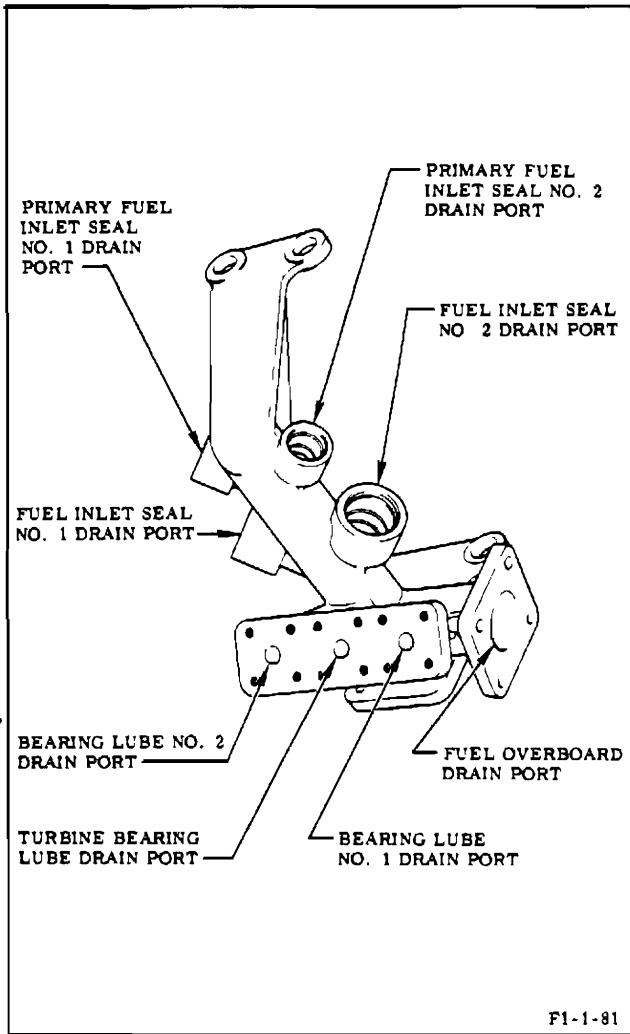
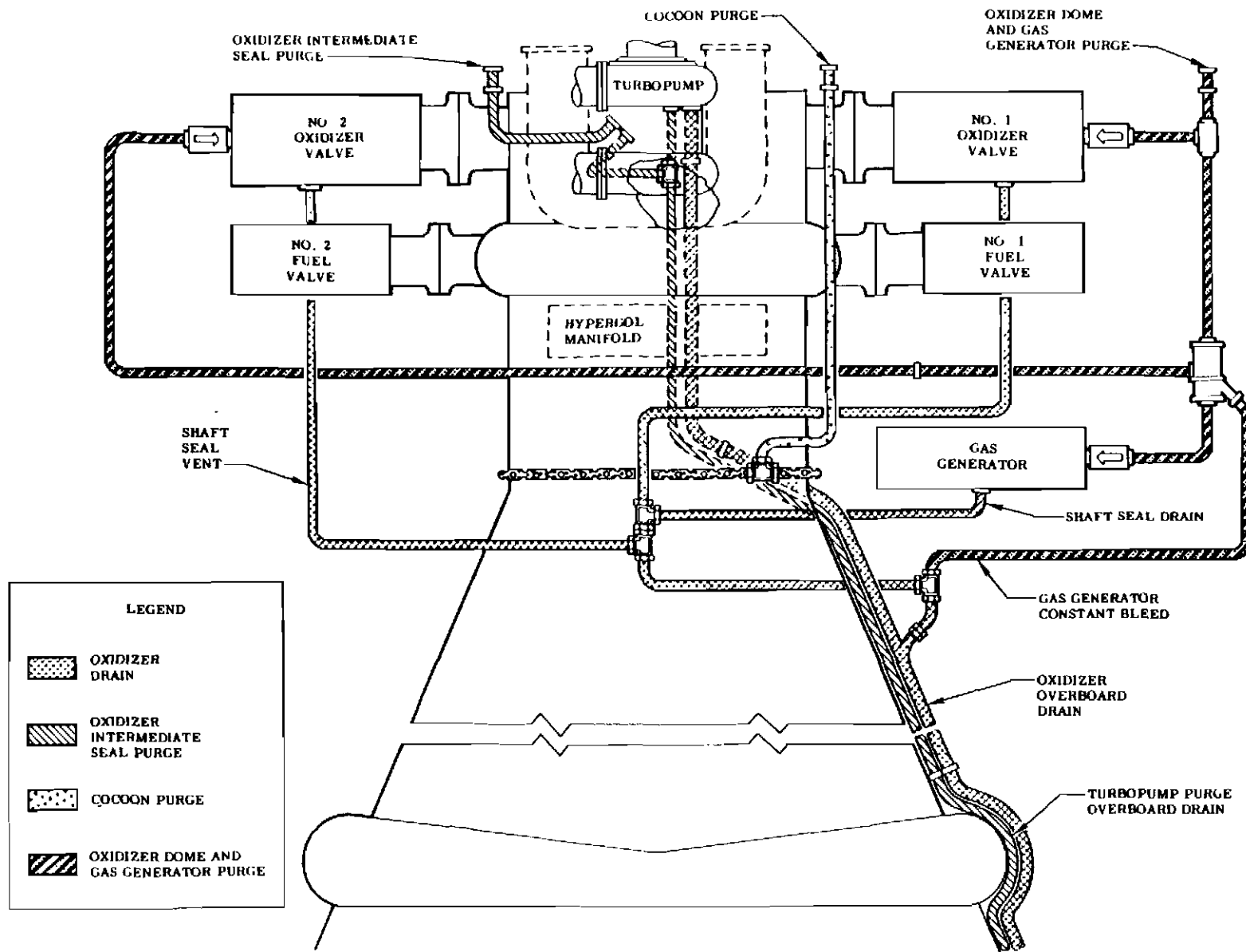

Figure 1-48. Fuel Drain Manifold



F1 1-79

Figure 1-49. Engine Purge and Oxidizer Overboard Drain Schematic

PROPELLANTS

| | |
|-----------------------------------|---|
| Liquid oxygen (MIL-P-25508) | Gas generator and thrust chamber combustion |
| Propellant kerosene (MIL-P-25576) | Gas generator and thrust chamber combustion |

PNEUMATICS

| | |
|---|---|
| 800 psig gaseous nitrogen (MIL-P-27401) | Gas generator and thrust chamber domes purge |
| 80 psig gaseous nitrogen (MIL-P-27401) | Turbopump oxidizer seal purge |
| 100-200 psig gaseous nitrogen (MIL-P-27401) | Thermal insulation cocoon purge |
| 250 psia helium (Bureau of Mines, Grade A) | Heat exchanger (vehicle fuel tank pressurization) |

ELECTRICAL POWER

| | |
|---------|---|
| 5 vdc | Engine instrumentation system (valve potentiometer) |
| 28 vdc | Engine control system |
| 28 vdc | Engine instrumentation system (transducers) |
| 5 vdc | Engine instrumentation system (transducer checkout) |
| 220 vac | Turbopump heaters |
| 500 vac | Engine pyrotechnic igniters |

MISCELLANEOUS

| | |
|--|--|
| Pyrotechnic igniters (2) | Gas generator ignition |
| Pyrotechnic igniters (2) | Thrust chamber nozzle extension ignition |
| Hypergol igniter (1) | Thrust chamber ignition |
| Prefill fluid (105 gallons of ethylene glycol and water) | Thrust chamber tube inert prefill |
| 1,500 psig propellant kerosene (MIL-P-25576) or RJ-1 fuel (MIL-F-25558) pressure | Fluid power supply (prior to mainstage) |

Figure 1-50. Engine Facility Requirements

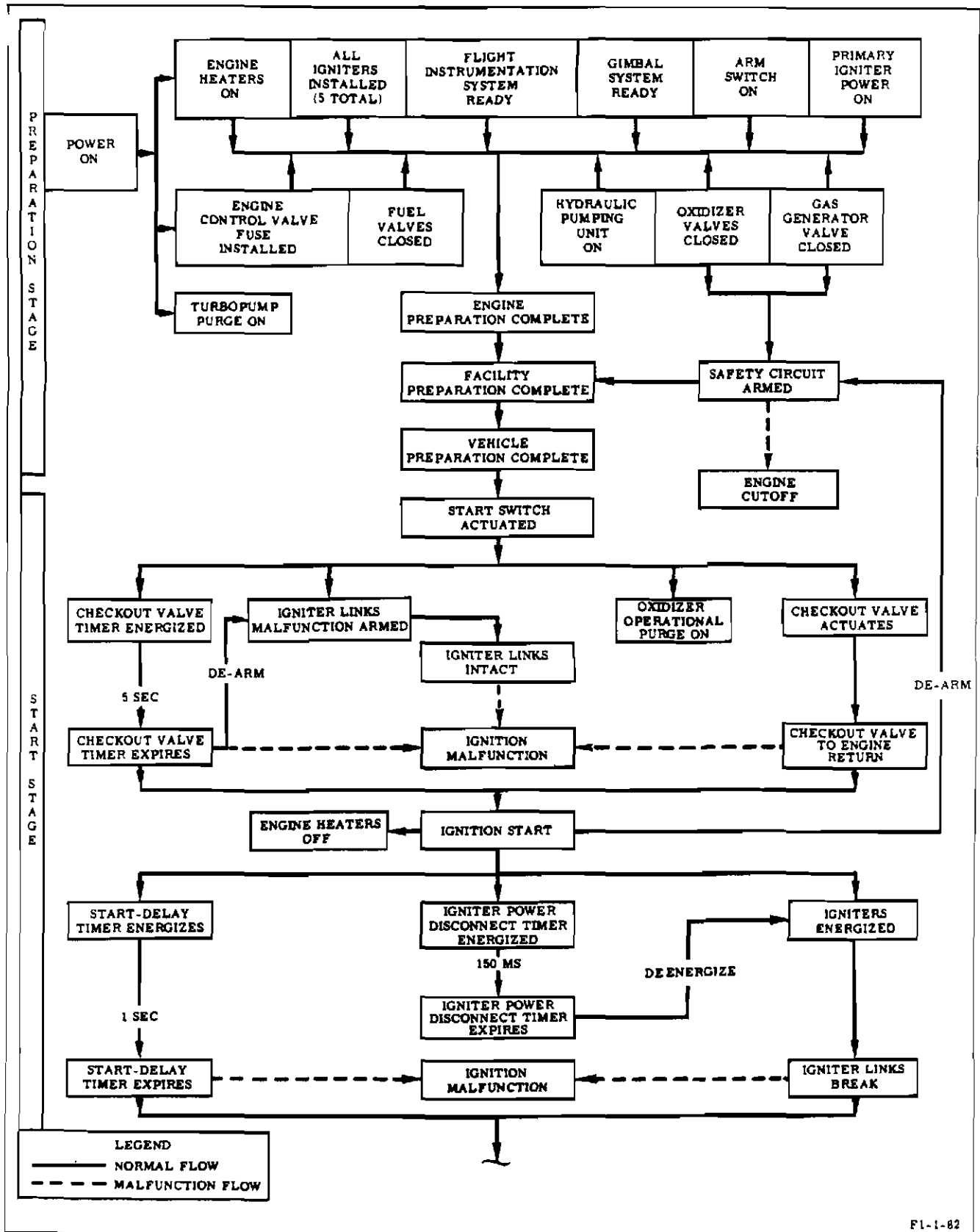

F1-1-82

Figure 1-51. Engine Start Sequence (Typical Single Engine) (Sheet 1 of 2)

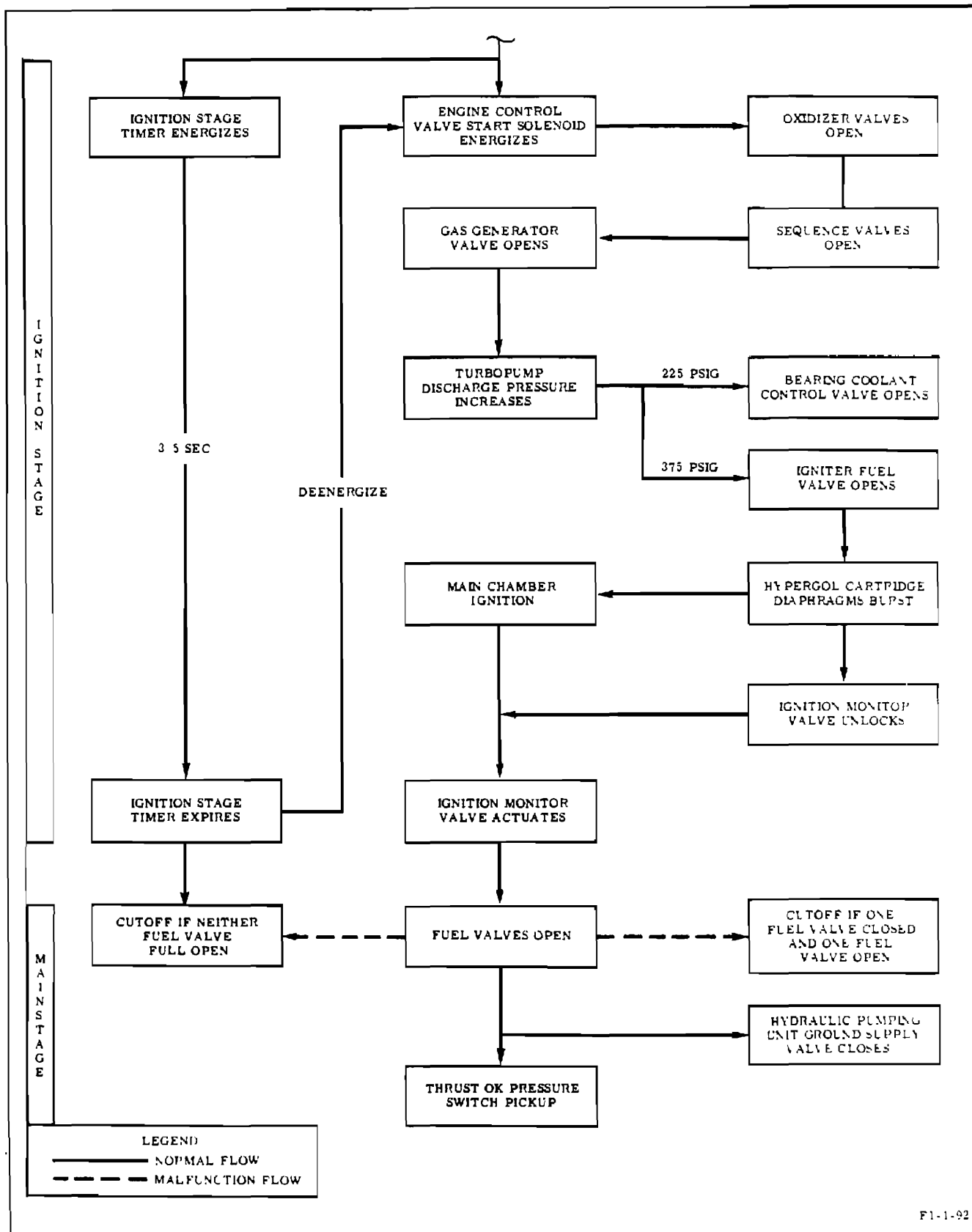

F1-1-92

Figure 1-51. Engine Start Sequence (Typical Single Engine) (Sheet 2 of 2)

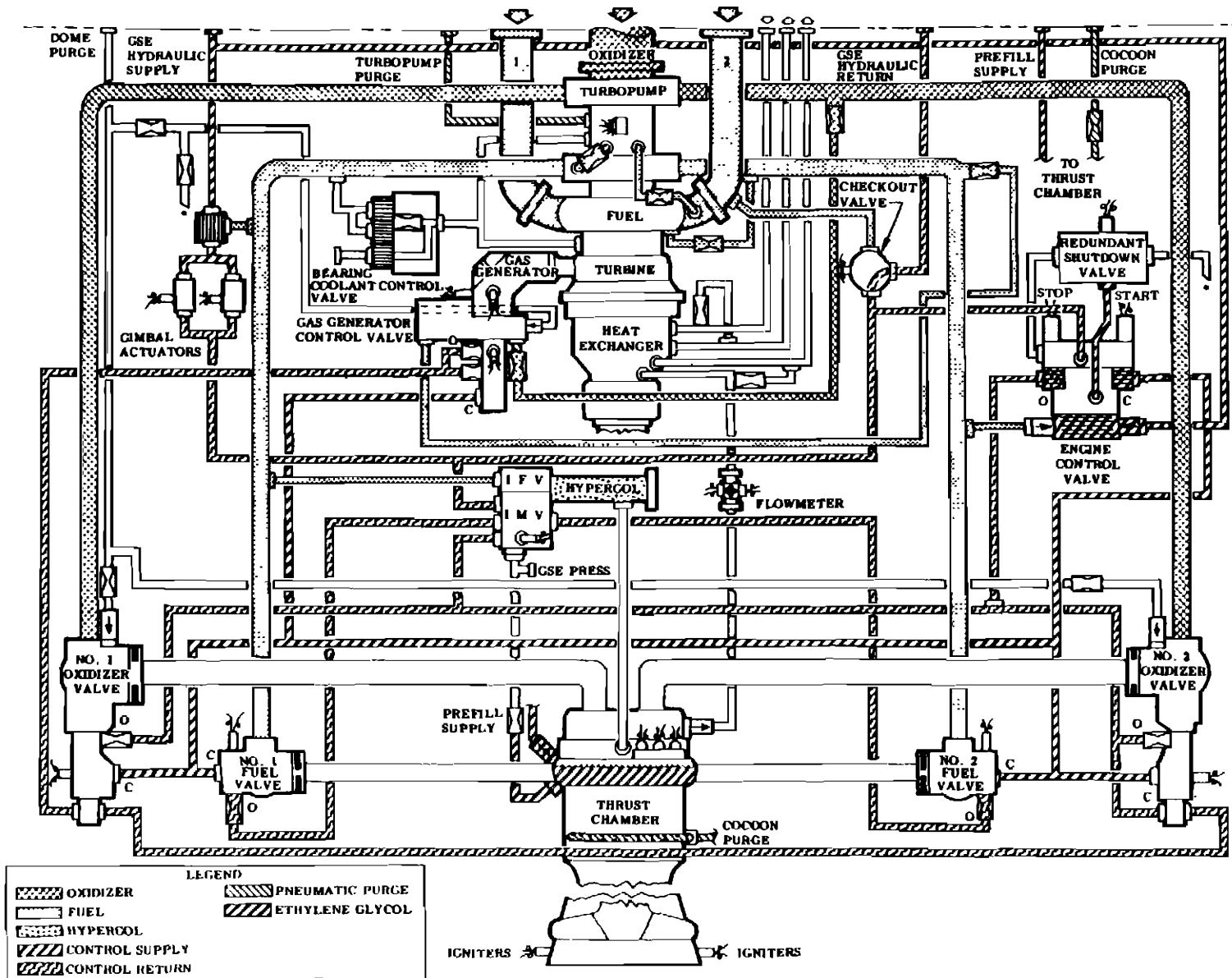

Figure 1-53. Engine Preparation Complete (Typical Single Engine)

1-125. ENGINE START AND IGNITION STAGE.

1-126. The engine start and ignition stage is that part of the engine operation that is initiated with the manual actuation of the engine start switch and extends through the period during which the propellant valves are opened, combustion of the propellants is established, and transition into mainstage takes place. The actuation of the engine start switch electrically initiates the automatic start sequence that causes the checkout valve to rotate to the engine return position, the oxidizer dome operational purge to come on, and a checkout valve timer to energize. When the checkout valve timer expires and the checkout valve is in the engine return position, the turbopump heaters are deenergized, electrical power is applied to the gas generator and nozzle extension pyrotechnic igniters, and a start delay timer energizes. When the start delay timer expires and burning of the igniters is electrically verified by the severance of the igniter links, the start solenoid of the engine control valve and an ignition stage timer are energized. The actuation of the start solenoid causes the control spool of the engine control valve to shuttle, which removes ground-supplied hydraulic closing control fluid from the propellant valves and applies the control fluid to the opening port of the No. 1 and No. 2 oxidizer valves and the inlet port of the ignition monitor valve.

1-127. Opening of the oxidizer valves permits oxidizer to flow to the combustion zone of the thrust chamber and also mechanically opens the sequence valves. When the sequence valves open, control fluid is directed to the opening port of the gas generator control valve. Opening of the gas generator control valve admits propellants to the gas generator combustor where the propellants are ignited by the gas generator igniters. The resultant fuel-rich hot gases are directed through the turbine and the thrust chamber exhaust manifold to the nozzle extension where the gases combine with the oxidizer-rich atmosphere in the thrust chamber and are ignited by the nozzle extension igniters. Flow of the gas generator combustion gases through the turbine causes turbopump rotation and the attendant increase of fuel and oxidizer pump discharge pressure.

1-128. When the fuel pump discharge pressure attains approximately 225 psig, the bearing coolant control valve opens and directs fuel to the turbopump bearings for lubrication and bearing cooling. When the fuel pump discharge pressure increases to approximately 375 psig, the igniter fuel valve poppet is offseated, admitting fuel to the hypergol igniter. The hypergol cartridge burst diaphragms rupture, which directs the hypergolic fluid, followed by ignition fuel, to flow to the thrust chamber combustion zone and establish ignition. The rupturing of the hypergol cartridge diaphragms unlocks the ignition monitor valve, and thrust chamber combustion pressure of approximately 20 psig, sensed at the control port of the ignition monitor valve, causes the ignition monitor valve poppet to shuttle. Shuttling of the poppet directs the control fluid at the inlet port to flow to the opening ports of the No. 1 and No. 2 fuel valves.

1-129. ENGINE MAINSTAGE.

1-130. Engine mainstage is that period of engine operation that is initiated when the engine has attained 90 percent of its rated thrust. Mainstage is signalled by the actuation of the thrust OK pressure switches. During the transition into mainstage, the control system pressure source is automatically transferred to the engine at the time engine fuel discharge pressure exceeds ground-supplied pressure. When the fuel valves reach the open position, the supply valve in the ground source control system supply line is closed. The ignition stage timer, which would have initiated an engine cutoff if the fuel valves had not opened within the time limit of the timer, expires and deenergizes the engine control valve start solenoid. The control spool is unaffected, because the spool has been hydraulically locked in the valve's open position.

1-131. ENGINE CUTOFF.

1-132. Engine cutoff is initiated electrically by simultaneously energizing the engine control valve stop solenoid and the redundant shutdown valve solenoid. When the engine control valve stop solenoid is energized, the control spool is shuttled to the valve's closed position, which removes opening pressure and applies closing

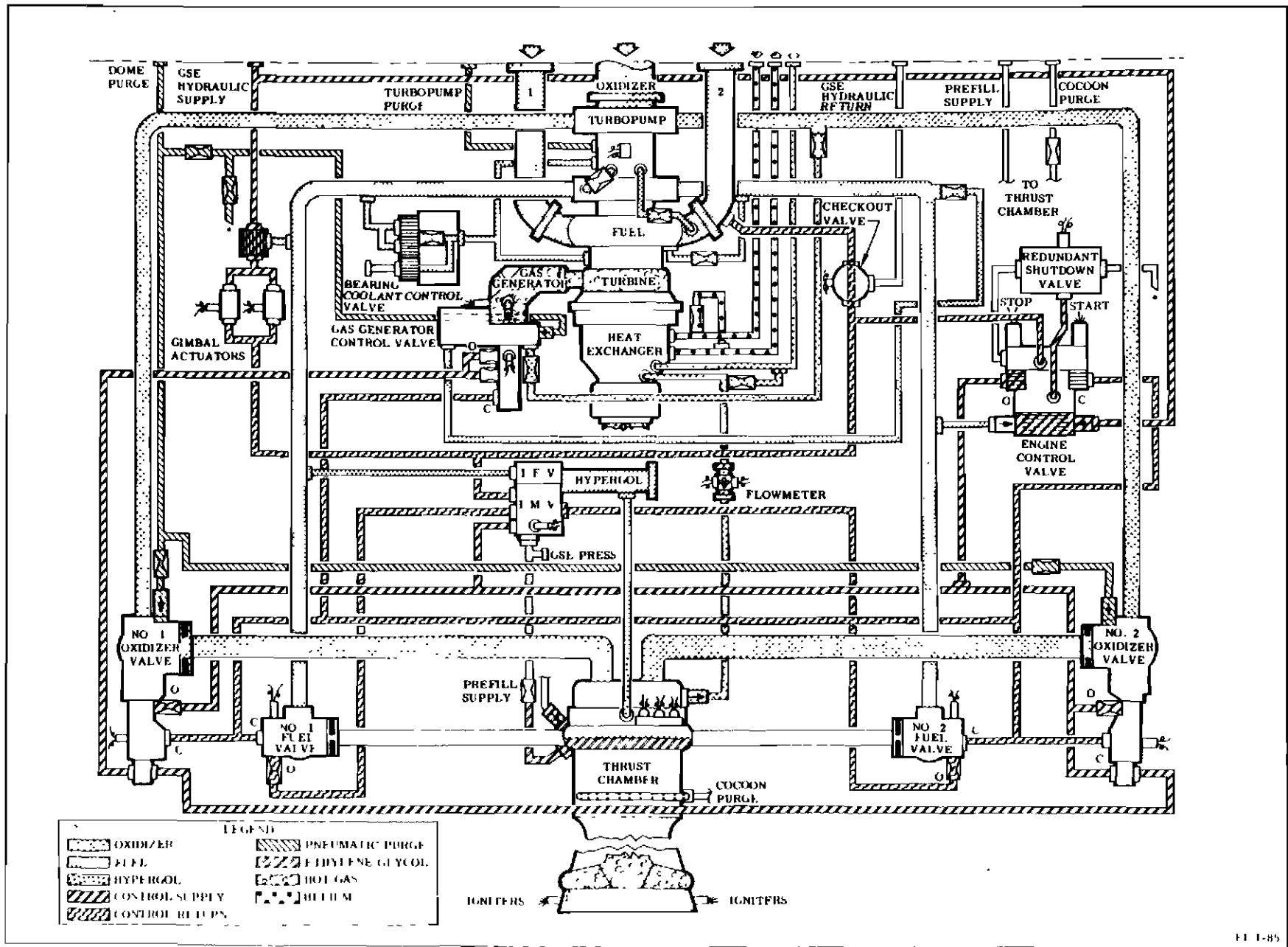
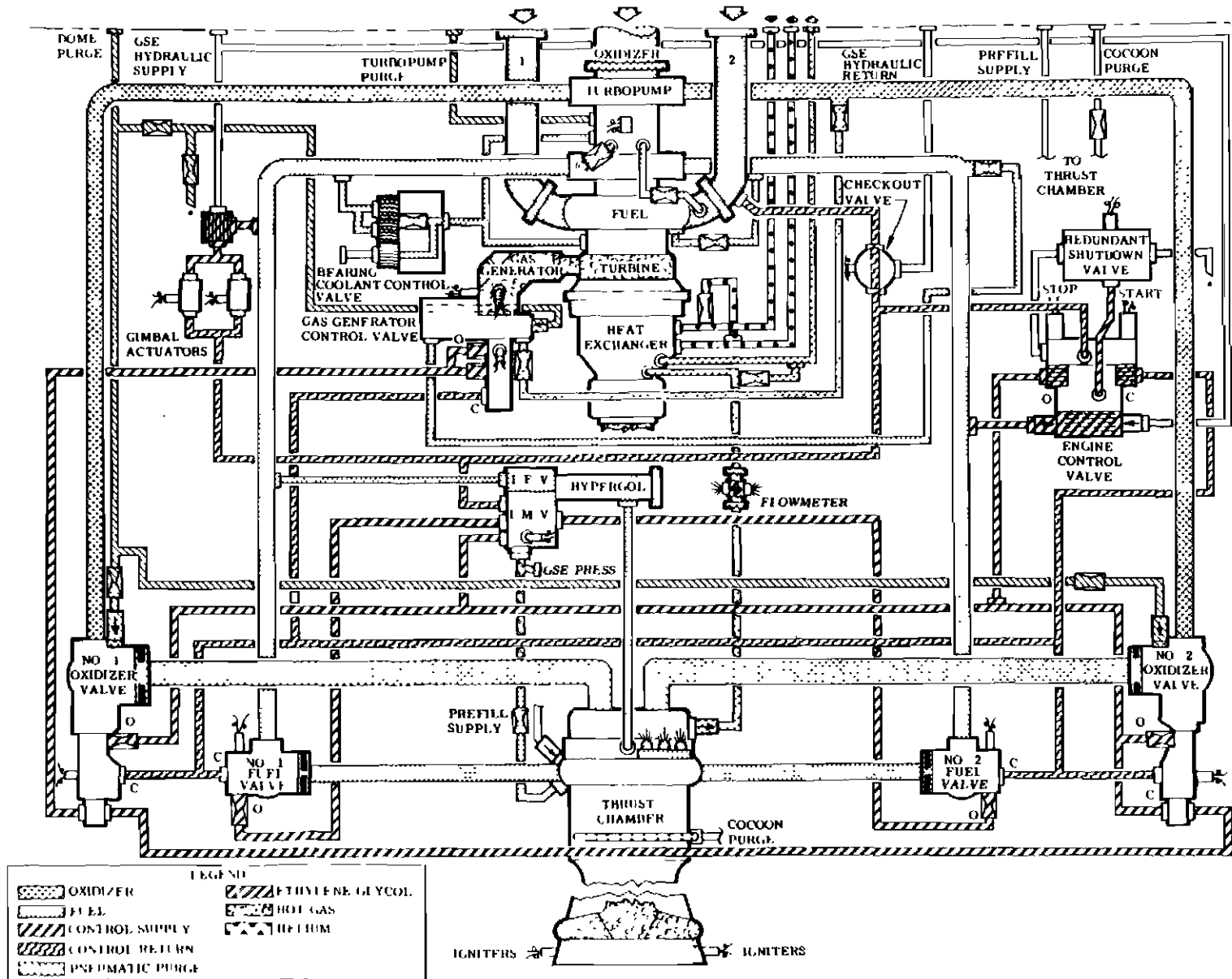

Figure 1-54. Engine Ignition Stage



FT 1-66

Figure 1-55. Engine Mainstage

pressure to the propellant valves. Energizing the redundant shutdown valve permits the valve to hydraulically actuate and direct control system pressure to the override port of the engine control valve. Pressure to the override port will cause the control spool to shuttle to the valve's closed position if the spool had not repositioned when the stop solenoid was energized. When closing control pressure is applied to the propellant valves, orifices in the control lines will sequence the gas generator control valve, oxidizer valves, and fuel valves closed, in that order.

1-133. At the time engine cutoff is initiated, the turbopump bearing heaters are reactivated and the oxidizer service purge is energized. Closing of the gas generator control valve removes power that drives the turbine and causes rapid decay of fuel discharge pressure. As fuel pressure decays, the igniter fuel valve and bearing coolant control valves close. Closing of the oxidizer and fuel valves causes a decay of combustion zone pressure in the thrust chamber and the resultant closing of the ignition monitor valve. When both the No. 1 and No. 2 fuel valves reach the closed position, the checkout valve is automatically returned to the ground return position and the ground source control system supply valve is reopened to supply closing pressure to the propellant valves until all residual propellants are drained from the engine.

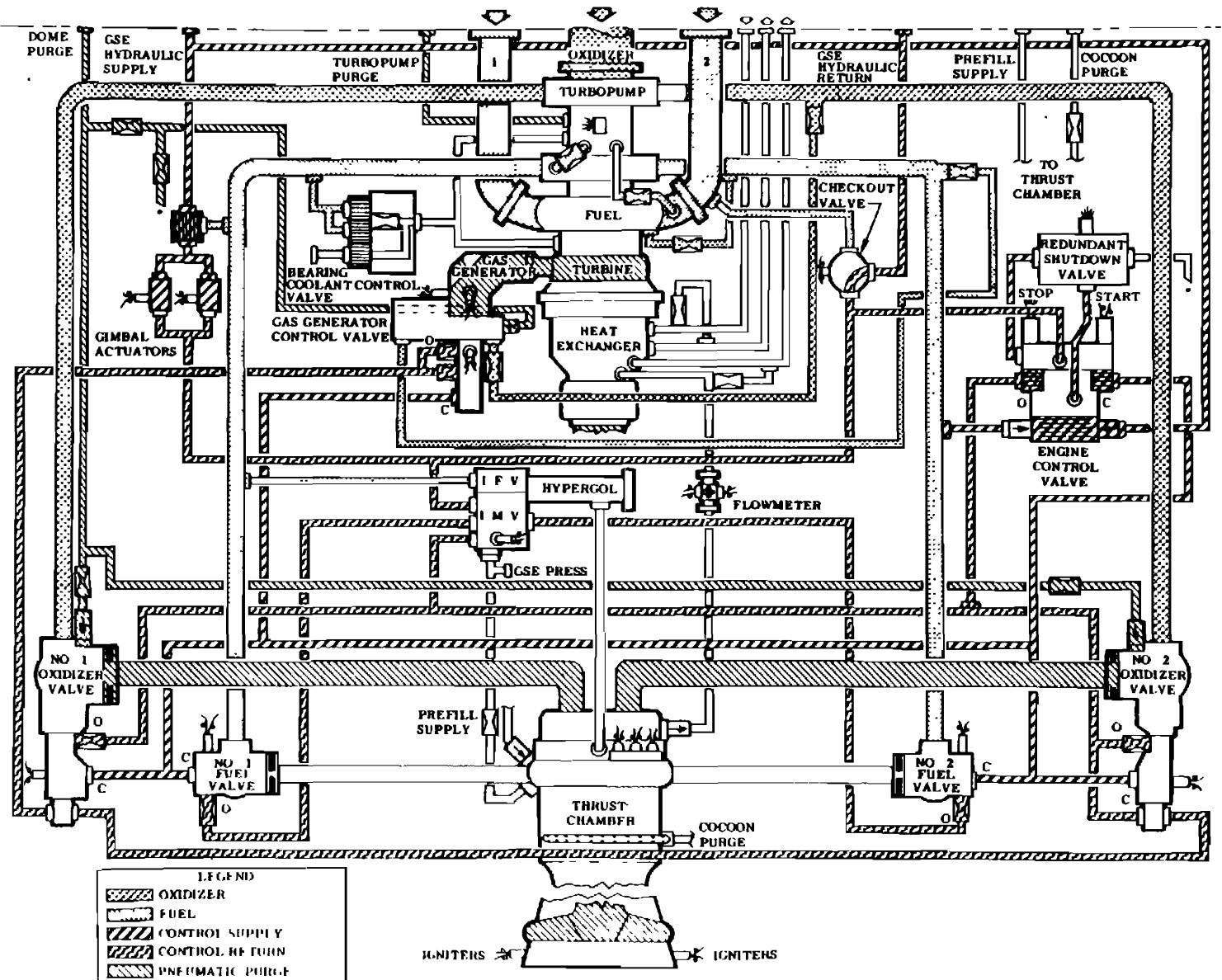

F1 1 87

Figure 1-56. Engine Cutoff

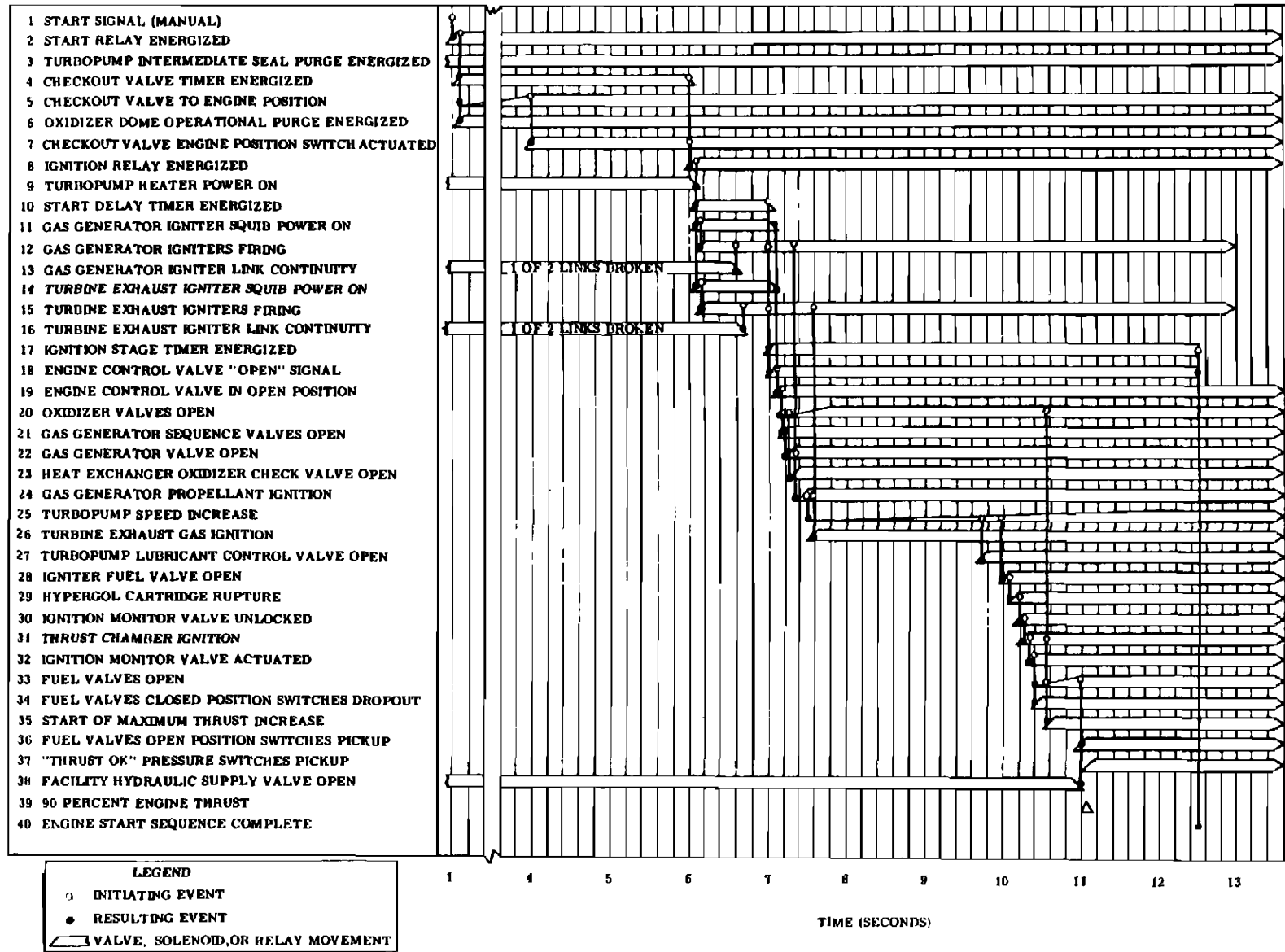

F1 1 36A

Figure 1-57. Engine Start Sequence Flow (Typical)

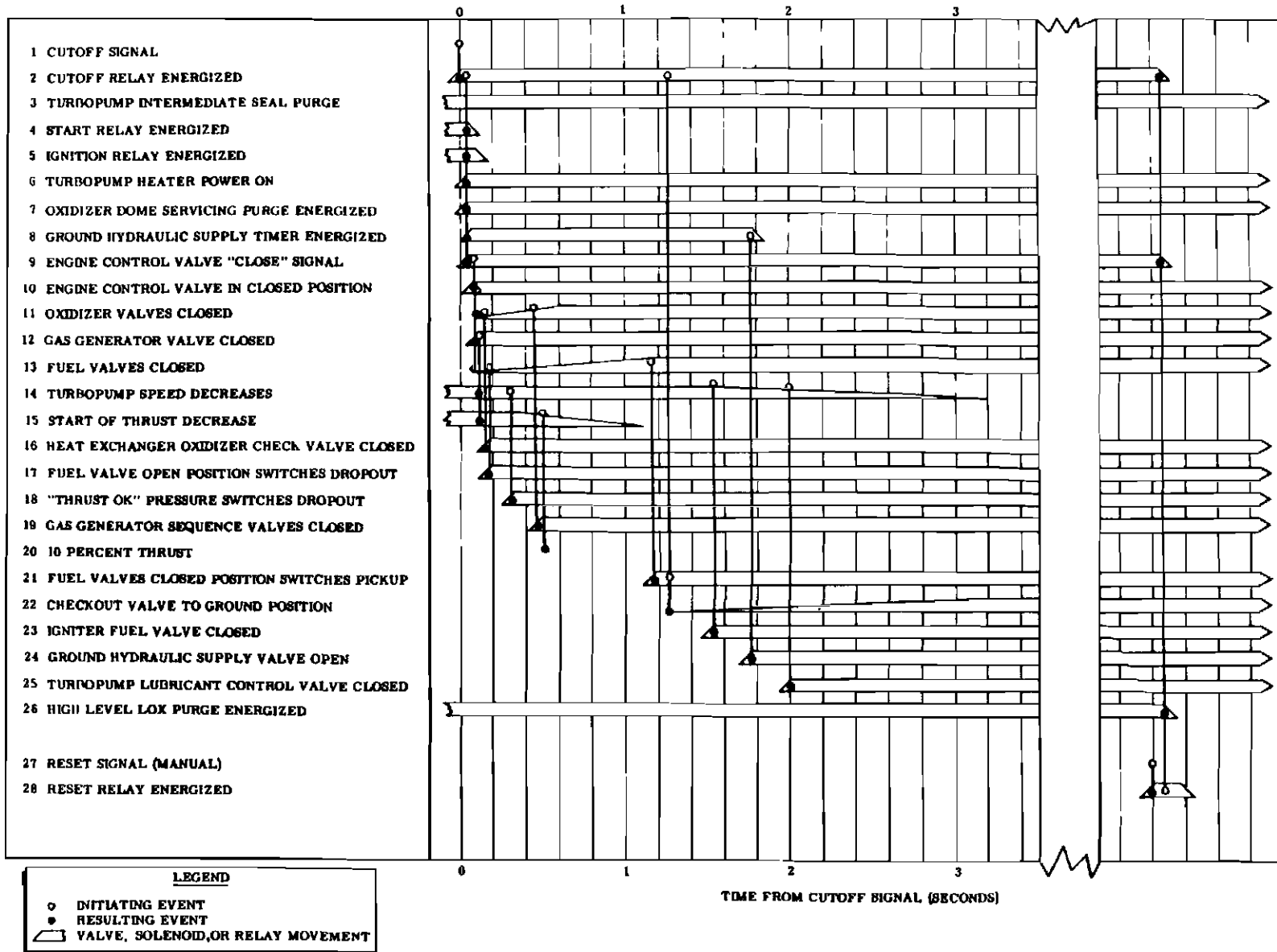

Figure 1-58. Engine Cutoff Sequence Flow (Typical)

1-134. F-1 ENGINE FLOW.

1-135. The following describes F-1 engine flow (figure 1-59) and events that take place from the time of Customer acceptance of the engine at Rocketdyne, Canoga Park, through Apollo/Saturn V launch at Kennedy Space Center (KSC). After official acceptance of the engine (signing of DD Form 250), modifications may be made or maintenance tasks may be performed, with Customer approval, before shipment. The engine, nozzle extension, and loose equipment are shipped to the Michoud Assembly Facility (MAF) by either truck or ship. (Thermal insulation (TIS) is shipped to MAF by truck.) At MAF the engine is inspected and then assigned to a stage, designated as a spare, or left unassigned. Spare engines and unassigned engines are processed to a specific condition and placed in storage until needed. The normal flow of assigned engines consists of installing loose equipment and TIS brackets, performing modifications and maintenance, and installing the thrust vector control system on outboard engines. Single-engine checkout is performed, wrap-around ducts and hoses are installed, and the engines are installed in the stage. The stage and nozzle extensions are then shipped to the Mississippi Test Facility (MTF) by barge.

1-136. The stage is installed in the static test stand at MTF where the engines are inspected, and nozzle extensions, slave hardware, and static test instrumentation are installed. A pre-static checkout of the stage is performed, followed by a static test, to determine stage acceptability and flight readiness. After a successful stage static test, the engines are inspected, test data is reviewed, and the turbo-pumps are preserved. The nozzle extensions, slave hardware, and static test instrumentation are removed; then the stage is removed from the test stand, and the stage and nozzle extensions are shipped to MAF by barge. During normal stage flow at MAF, the installed-engines are inspected and refurbished; then a post-static checkout and a pre-shipment (to KSC) inspection are performed. The stage may be stored at MAF after engine refurbishment, depending on the stage schedule. The stage, nozzle extensions, loose equipment, and TIS are shipped to KSC by barge.

1-137. At KSC the stage is erected onto the Launch Umbilical Tower (LUT) in the Vertical Assembly Building (VAB), where a visual

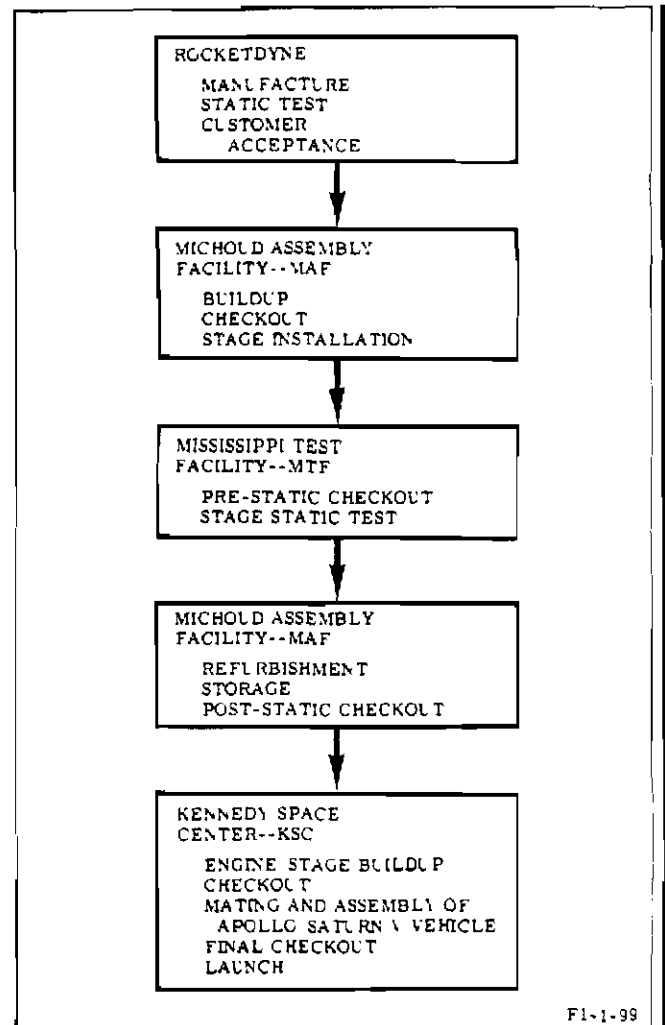

Figure 1-59. F-1 Engine Flow

inspection is performed, loose equipment is installed, modifications are made, and maintenance tasks are performed. Stage and engine leak and functional tests are performed, and final installation of the TIS is completed. While the first stage is being prepared, other tasks are being done to prepare the remaining stages and modules, and the spacecraft, to mate and assemble them into the complete Apollo/Saturn V Vehicle. The vehicle and mobile launcher are then moved from the VAB to the launch pad on the crawler transporter, where launch preparations and final checkouts are performed. With all preparations complete and all systems ready, the Apollo/Saturn V is launched. After launch, a post-flight data evaluation is made, to determine that the S-IC

stage engines operated within the specified values during vehicle launch.

1-138. ENGINE FLOW BEFORE FIELD DELIVERY.

1-139. CUSTOMER ACCEPTANCE INSPECTION.

1-140. Customer acceptance inspection is performed when Contractor engine activity at Canoga Park is complete. The Customer reviews all documentation including Component Test Records, Engine Buildup Records, Engine Test Records, and Engine Acceptance Test Records in the Engine Log Book. The Customer verifies that the engine configuration information on the engine MD identification plate corresponds to that listed in the Engine Log Book, and upon acceptance of all records and documentation, signs DD Form 250, which constitutes official acceptance of the engine by the Customer.

1-141. POST-DD250 MAINTENANCE OR MODIFICATION.

1-142. If required before field delivery of an engine, post-DD250 maintenance or modification, as required by Engineering Change Proposals (ECPs) and Engine Field Inspection Requests (EFIRs), can be done at Rocketdyne with Customer approval. Upon completion of maintenance or modification, the Engine Log Book is updated, and the engine is accepted by the Customer.

1-143. ENGINE SHIPMENT TO MAF.

1-144. The engine, nozzle extension, and loose equipment is shipped to MAF by truck or ship as directed by the Customer. See figure 1-60. Detailed requirements for shipping the engine are in R-3896-9. Detailed requirements describing the use of handling equipment are in R-3896-3.

1-145. PREPARATION FOR SHIPMENT.

1-146. Preparation for shipment at the Contractor's facility consists primarily of removing the engine from buildup and test equipment, installing the engine and nozzle extension in shipping equipment, and packaging the loose equipment. Engine Rotating Sling G4050 is installed on the engine and a facility hoist lifts

the sling and rotates the engine from vertical to the lowered (shipping) position, or from horizontal to the lowered position. A gaseous nitrogen purge is applied to the oxidizer pump seal during the time the engine is being rotated to the horizontal or lowered position. The engine is then secured on Air Transport Engine Handler G4044 in the lowered position and the sling removed. If the engine is to be shipped cross-country by truck, the turbopump shaft preload fixture is installed. A check is then made to make sure that Thrust Chamber Throat Security Closure G4089 is installed, that all desiccant is correctly secured, that the humidity range is acceptable, that openings are covered with suitable closures, and that the gimbal bearing is immobilized with Gimbal Bearing Lock G4059. The frame and Engine Cover G4047 are installed on the engine with the necessary forms sealed in the security pouch. Using a facility hoist and Engine Handler Sling G4052, the nozzle extension is installed on Nozzle Extension Handling Fixture G4080 and the loaded nozzle extension installed on Handling Adapter G4081. Because of shipping regulations governing transportation of ignition devices, the engine hypergol cartridge and pyrotechnic igniters are not shipped with the engine.

1-147. SHIPPING BY TRUCK.

1-148. Trucks are used to transport the engine, nozzle extension, and loose equipment, cross-country or to and from dock sites. Using a facility hoist and Engine Handler Sling G4052, the handler-installed engine and loaded nozzle extension (installed on the handling adapter) are loaded and secured on a low-bed, air-ride-equipped trailer. Loose equipment is packaged in boxes, loaded by forklift, and secured. For cross-country shipping, a calibrated impact recorder is installed on the handler. A truck transport checklist is used as a guide to verify that specified procedures are performed before truck departure and during cross-country shipping.

1-149. SHIPPING BY SHIP.

1-150. The engine, nozzle extension, and loose equipment are delivered to the ship by truck. The low-bed trailer is positioned on the ship's deck. Using a mobile crane, Engine Handler Sling G4052, and tractor, the Handler-installed engine is removed from the trailer, placed on the cargo deck; then moved forward and

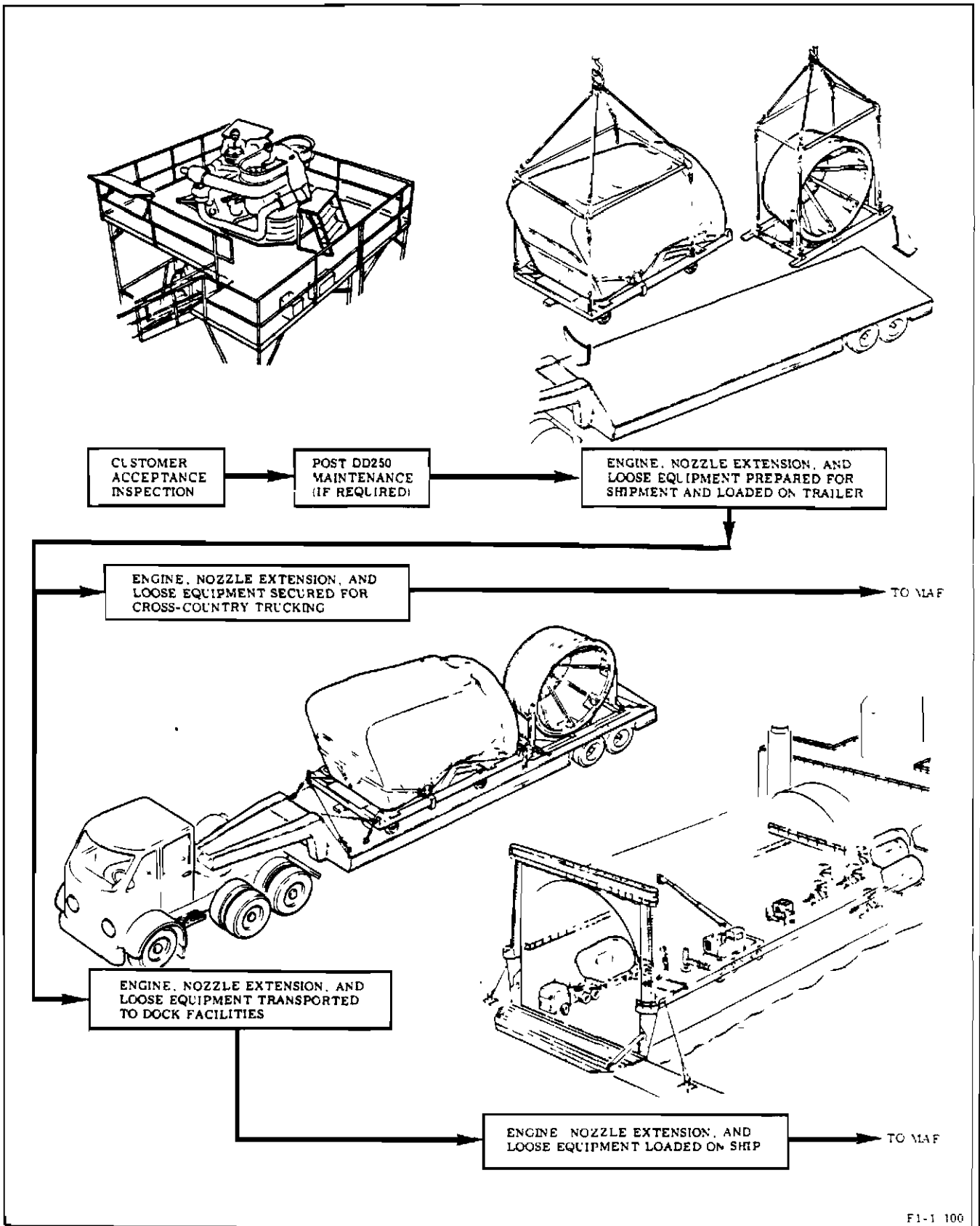

F1-1 100

Figure 1-60. Engine Shipment to MAF

secured. The nozzle extension and loose equipment are removed from the trailer by mobile crane or forklift and secured to the cargo deck. The water transport checklist is used as a guide to verify that specified procedures are performed before departure, in transit, and after docking.

1-151. RECEIVING ENGINE AT MAF.

1-152. The Stage Contractor receives the engine and is responsible for engine flow at MAF. See figure 1-61. Detailed requirements for engine receiving by truck and ship are in R-3896-9. Detailed requirements describing the use of engine handling equipment are in R-3896-3.

1-153. RECEIVING BY TRUCK.

1-154. Engines, nozzle extensions, and loose equipment received by cross-country truck or by truck from the MAF dock are delivered to the Manufacturing Building where the equipment is visually inspected for shipping damage. If arriving at MAF by cross-country truck, the arrival time and date are recorded on the impact recorder chart. Using the facility hoist and Engine Handler Sling G4052, the handler-installed engine and nozzle extension are moved from the trailer to the floor. Loose equipment is removed from the trailer using a forklift. The nozzle extension is routed to the nozzle extension storage area, and loose equipment is routed to the Engine Support Hardware Center. The engine is routed to the engine area or to the bonded storage area (if unassigned), where the impact recorder and turbopump preload fixture are removed (if installed) and returned to Canoga Park.

1-155. RECEIVING BY SHIP.

1-156. When the ship arrives at the MAF dock, a tug, mobile crane, and low-bed trailer are positioned on the ship's cargo deck for the off-loading procedure. Using Engine Handler Sling G4052 and the mobile crane, the engine and nozzle extension are loaded and secured on the low-bed trailer. The loose equipment is loaded on the trailer by forklift. The trailers are moved into the Manufacturing Building, where the engine, nozzle extension, and loose equipment are inspected for shipping damage. Engine receiving then proceeds as described in paragraph 1-153.

1-157. UNASSIGNED-ENGINE FLOW AT MAF.

1-158. Unassigned-engine flow at MAF pertains to unassigned and spare engines. Upon receipt at the Manufacturing Building, unassigned engines are inspected for shipping damage, moved to the bonded storage area, inspected, and stored until scheduled for modification and/or assigned to a stage. Spare engines are processed through buildup and single-engine checkout, moved to the bonded storage area, and stored in a standby condition in case engine replacement is required. Single-engine checkout is required for all engines in storage over six months. If any discrepancies are observed during engine flow at MAF, Engine Contractor personnel perform unscheduled maintenance and repair or replace discrepant hardware on the engine. Discrepant hardware removed from the engine is routed to the CM&R area, where it is repaired and tested.

1-159. STORAGE RECEIVING INSPECTION.

1-160. Unassigned engines are visually inspected in the bonded storage area. The engine cover is removed, and the engine inspected for damage, corrosion, residual fluid on exterior surfaces, and surface wetting on the hydraulic control system exterior. It is verified that specified areas of the engine are coated with corrosion preventive, that humidity indicators indicate blue, and that line markings are correct. The turbopump preservation status is checked in the Engine Log Book, and the turbopump is serviced if required. The engine cover is reinstalled. Detailed inspection requirements for engines in storage are in R-3896-11.

1-161. ENGINE FLOW AT MAF. (See figure 1-62.)

1-162. When an uninstalled engine is received in the engine area, it is removed from Air Transport Engine Handler G4044, rotated to the vertical position, and placed on Engine Handling Dolly G4058 using Engine Rotating Sling G4050 and the facility hoist. The engine is then moved into a workstand where receiving inspection and engine buildup are accomplished. After engine buildup, the engine is placed into a test stand for single-engine checkout and installation of wrap-around lines. The engine is then removed from the test stand, rotated to the horizontal position, and installed on Engine Handler G4069. The oxidizer pump seal is purged with gaseous

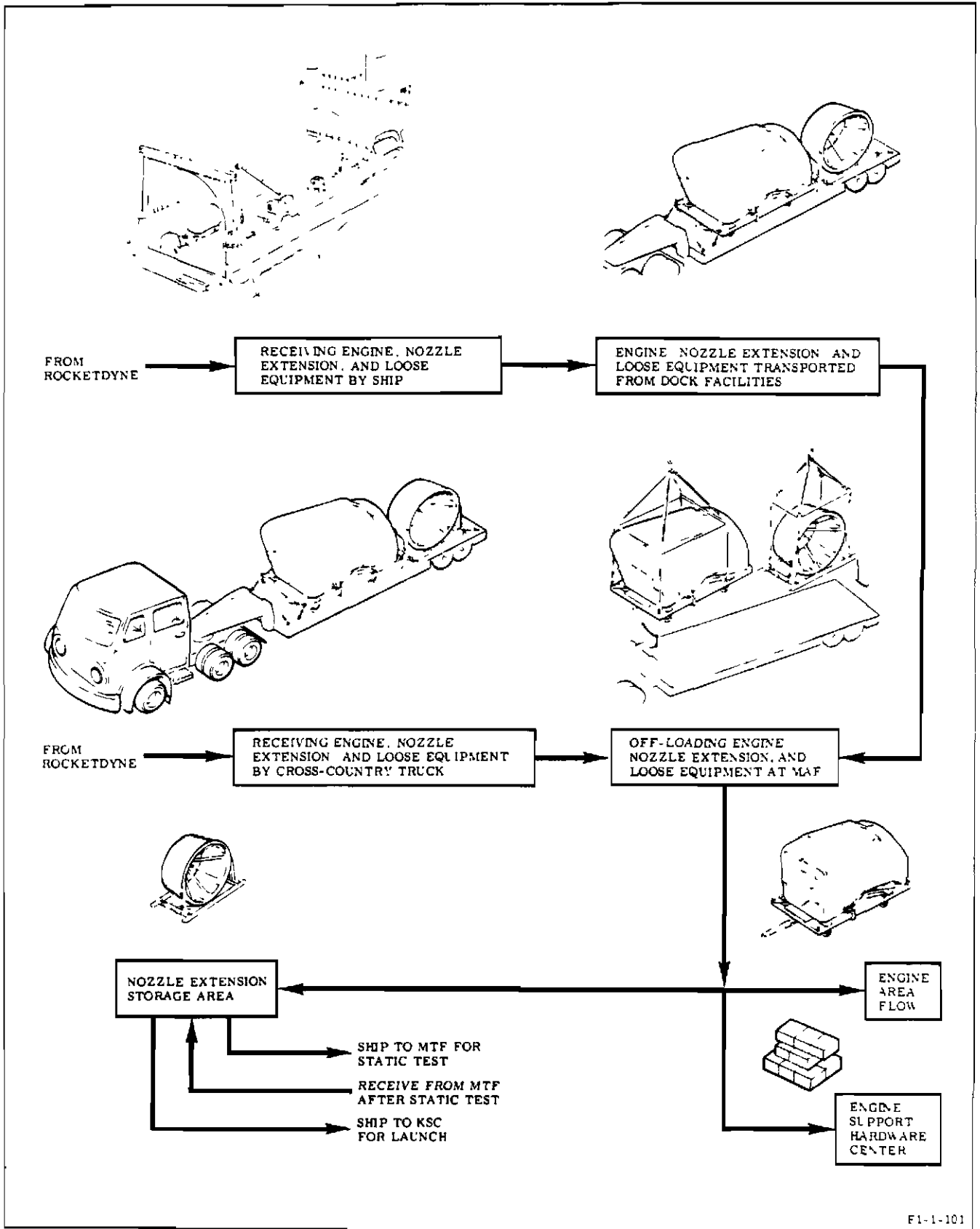
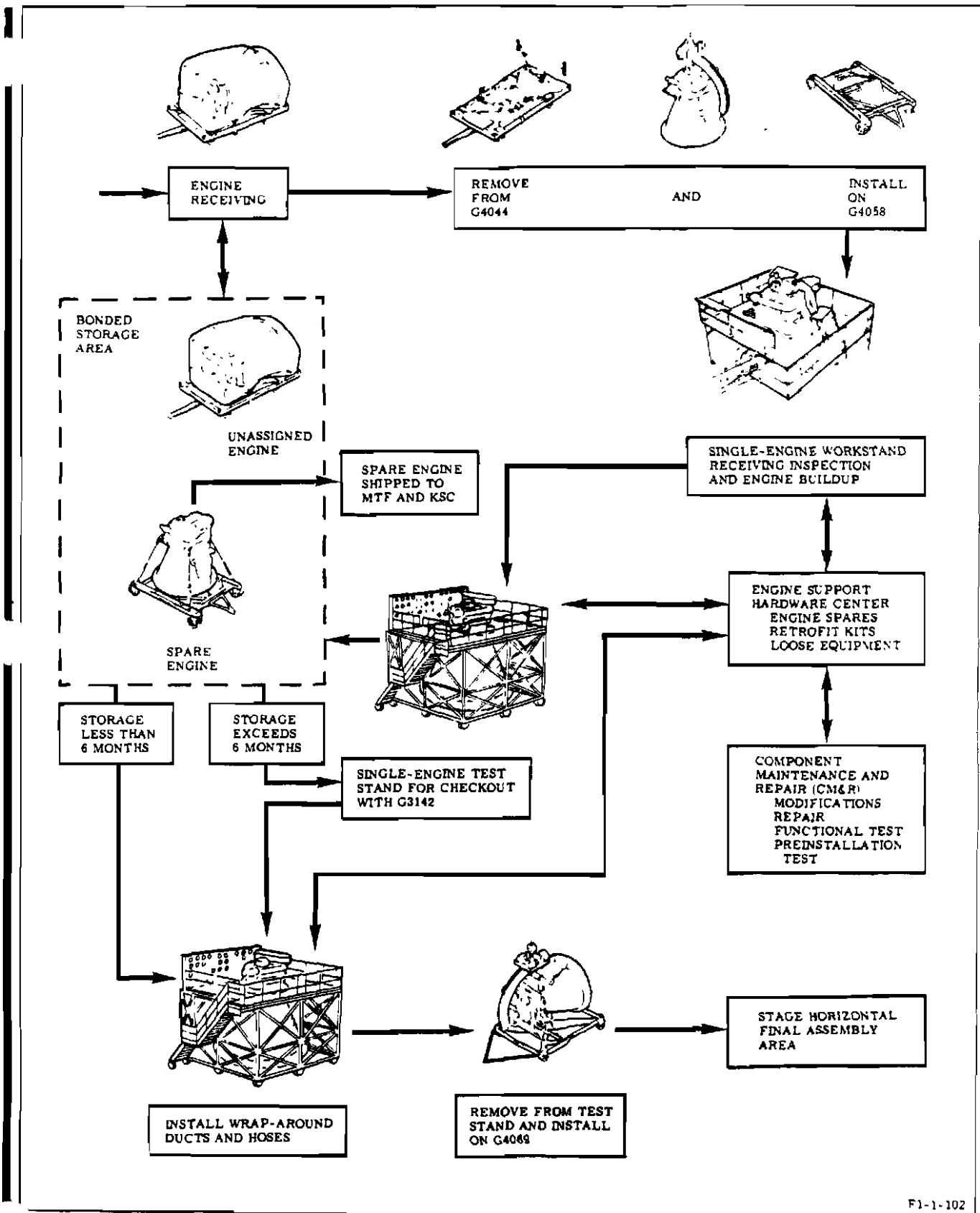

Figure 1-61. Receiving Engine at MAF



F1-1-102

Figure 1-62. Engine Flow at MAF

nitrogen during engine rotation to the horizontal position and for 30 minutes (minimum) thereafter. The engine is moved to the Stage Horizontal Final Assembly Area, where the engine is prepared for installation, installed in the stage, and inspected in preparation for shipment to MTF. Engine modifications are made as required during engine flow at MAF. If any discrepancies are observed, Engine Contractor personnel perform unscheduled maintenance, and repair or replace hardware on the engine. Discrepant hardware removed from the engine is routed to the CM&R area, where it is repaired and tested. Detailed requirements describing the use of engine handling equipment are in R-3896-3.

1-163. RECEIVING INSPECTION.

1-164. After installation in the single-engine workstand in the engine area of the Manufacturing Building, each assigned engine undergoes an overall visual receiving inspection. The engine is visually inspected for damage, corrosion, and missing equipment; for evidence of fluid in drain line exits or on the engine exterior; and for surface wetting on the hydraulic control system exterior. It is verified that corrosion preventive and aluminum-foil tape is present in specified areas, line markings are correct, humidity indicators indicate blue, and there are no voids in the turbopump housing cavity filler material. A clean polyethylene bag is installed on the fuel overboard drain line, the turbopump preload fixture is removed, and orifice sizes and serialized components are checked against those listed in the Engine Log Book. Detailed inspection requirements for engines received at MAF are in R-3896-11.

1-165. ENGINE BUILDUP, MODIFICATION, AND MAINTENANCE.

1-166. LOOSE EQUIPMENT INSTALLATION. Loose equipment that does not interfere with single-engine checkout is installed during engine buildup. The electrical cable support post is installed only on engines assigned to the outboard positions. The interface panel-to-oxidizer inlet insulation seal is installed on all engines. Wrap-around ducts and hoses are not installed at this time.

1-167. THERMAL INSULATION BRACKETRY INSTALLATION. The field-installed thermal insulation bracketry is normally stored at MAF

until installation on the engine. All brackets are installed except for the bracket that attaches to the engine handling bearing. The engine handling bearing is an attach point for securing the engine onto Engine Handler G4069; therefore, the bracket is installed after the engine is installed on the stage. Requirements for installing thermal insulation brackets are in R-3896-6.

1-168. MODIFICATION AND MAINTENANCE. Modifications are made and maintenance tasks are performed during engine buildup, whenever possible. Engine modifications and special inspections consist of incorporating retrofit kits, as a result of Engineering Change Proposals (ECPs), and implementing Engine Field Inspection Requests (EFIRs). Engine maintenance involving component removal and replacement or turbopump disassembly, if required, is done in the engine workstands. Component modification, repair, and functional testing are done in the environmentally controlled CM&R area.

1-169. THRUST VECTOR CONTROL SYSTEM INSTALLATION. The thrust vector control system is installed by the Stage Contractor on engines assigned to the outboard positions. This system consists of two gimbal actuators, hydraulic supply and return lines, and a hydraulic filter manifold.

1-170. SINGLE-ENGINE CHECKOUT.

1-171. Single-engine checkout is done after receiving inspection and after engine buildup tasks are completed. The engine is installed in the test stand, where the ignition monitor valve sense tube is disconnected, Thrust Chamber Throat Security Closure G4089 removed, and Thrust Chamber Throat Plug G3136 installed. All connections are made between the engine and Engine Checkout Console G3142; facility electrical, pneumatic, and hydraulic sources are applied to the console; and the console is prepared for operation. Electrical system function and timing tests, a turbopump torque test, pressure tests, valve timing tests, and leak and function tests are done in accordance with the detailed requirements in R-3896-11. Upon completion of engine checkout, the ignition monitor valve sense tube is connected, Thrust Chamber Throat Plug G3136 removed, and Thrust Chamber Throat Security Closure G4089 installed.

1-172. WRAP-AROUND DUCT AND HOSE INSTALLATION.

1-173. The loose-equipment wrap-around ducts and hoses are installed on the engine in the test stand after single-engine checkout. The helium, GOX, and hydraulic wrap-around ducts and the purge and prefill hoses are installed and connected to flanges used for test setups during engine testing. The ducts and hoses are alined using alinement tool T-5041233 and supported with support set T-5046440 to prevent movement until the engine is installed in the stage and interface connections are completed. The engine is then removed from the test stand. Detailed requirements for installing and alining wrap-around ducts and hoses are in R-3896-3.

1-174. ENGINE INSTALLATION AT MAF.
(See figure 1-63.)

1-175. **PREPARATION FOR ENGINE INSTALLATION.** The engine is rotated to the horizontal position and installed on Engine Handler G4069 using Engine Rotating Sling G4050 and the facility hoist. The oxidizer pump seal is purged during engine rotation to the horizontal position and for 30 minutes (minimum) thereafter. After removing the interface panel access doors, the oxidizer and fuel inlet covers are removed, the inlets inspected for contamination, the oxidizer inlet screen and seal secured in place, and the inlets covered with Aclar film. The fuel overboard drain system is isolated using clean polyethylene bags. The gimbal boot cover is removed, and it is verified that the gimbal bearing locks are installed, the electrical cable support post is installed on engines assigned to outboard positions, and the engine gimbal wrap-around lines are installed and adequately supported. When ready for installation in the stage, the engine is moved to the Stage Horizontal Final Assembly Area and positioned under a mobile hoist (A-frame). Thrust Chamber Throat Security Closure G4089 is removed and the thrust chamber inspected. The engine horizontal installation tool is suspended from the mobile hoist, prepared for engine installation, and then installed in the thrust chamber. The engine is then removed from Engine Handler G4069 and raised and rotated to the position required for engine installation. Detailed requirements for fuel overboard drain system isolation and engine preparation for installation are in R-3896-11.

1-176. **ENGINE INSTALLATION.** (See figure 1-63.) When preparations for engine installation are completed and the engine is correctly positioned in the stage, the engine gimbal bearing is mated and secured to the stage attach point. On the outboard engines, the gimbal actuators are secured to the stage actuator locks, while on the inboard engines, the stiff arms are secured to the actuator locks. Gimbal bearing locks are removed, and the gimbal boot is reinstalled on the gimbal bearing. The engine horizontal installation tool is removed from the thrust chamber after the engine is secured to the stage; then the Thrust Chamber Throat Security Closure G4089 is installed. Aclar film is removed from engine oxidizer and fuel inlets, fuel inlet seals and screens are installed, and stage ducting is connected to the engine inlets. The interface electrical connectors and stage pressure switch checkout supply line are connected at the interface panel, and the wrap-around ducts and hoses are connected to the stage. The thermal insulation bracket that attaches to the engine handling bearing is installed as specified in R-3896-6. Detailed requirements for installing the engine are in R-3896-11.

1-177. **MANUFACTURING INSTALLATION VERIFICATION.** When engine installations and stage assembly are completed, the Stage Contractor performs a manufacturing installation verification. This verification consists of a gaseous nitrogen leak test of the engine interface connections and stage systems.

1-178. INSTALLED-ENGINE INSPECTION BEFORE STAGE SHIPMENT TO MTF.

1-179. The installed-engine inspection before shipment to MTF is made after the stage assembly and verification tests are complete. Each engine is visually inspected for damage, corrosion, and missing equipment; for evidence of fluid in drain line exits, fluid on the engine exterior; and for surface wetting on the hydraulic control system exterior. It is verified that corrosion preventive and aluminum-foil tape is present in specified areas, line markings are correct, the humidity indicator in the thrust chamber throat security closure indicates blue, and there are no voids in the turbopump housing cavity filler material. The fuel overboard drain system isolation polyethylene bags are visually inspected for fluid. If fluid is present, the bags

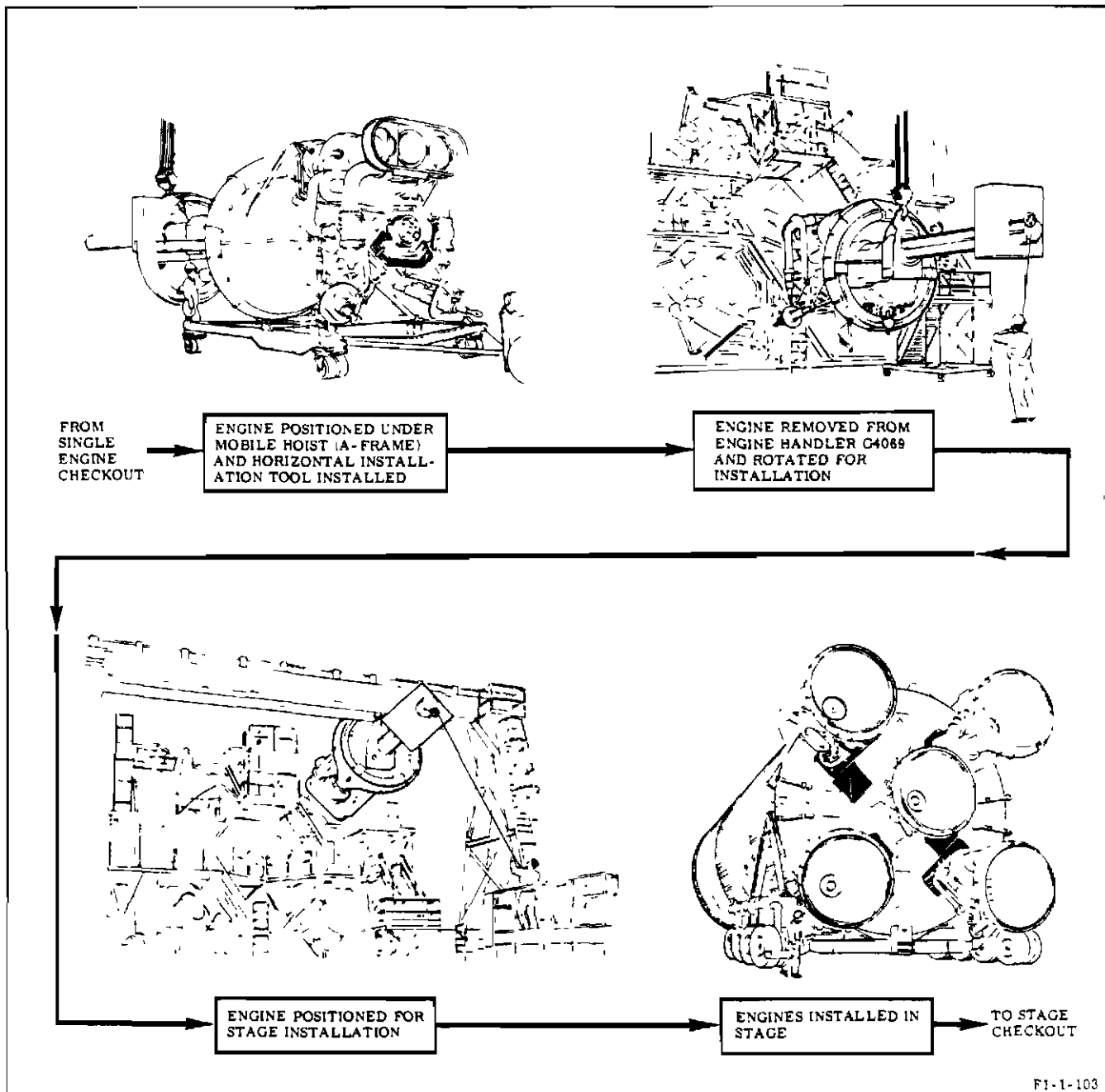
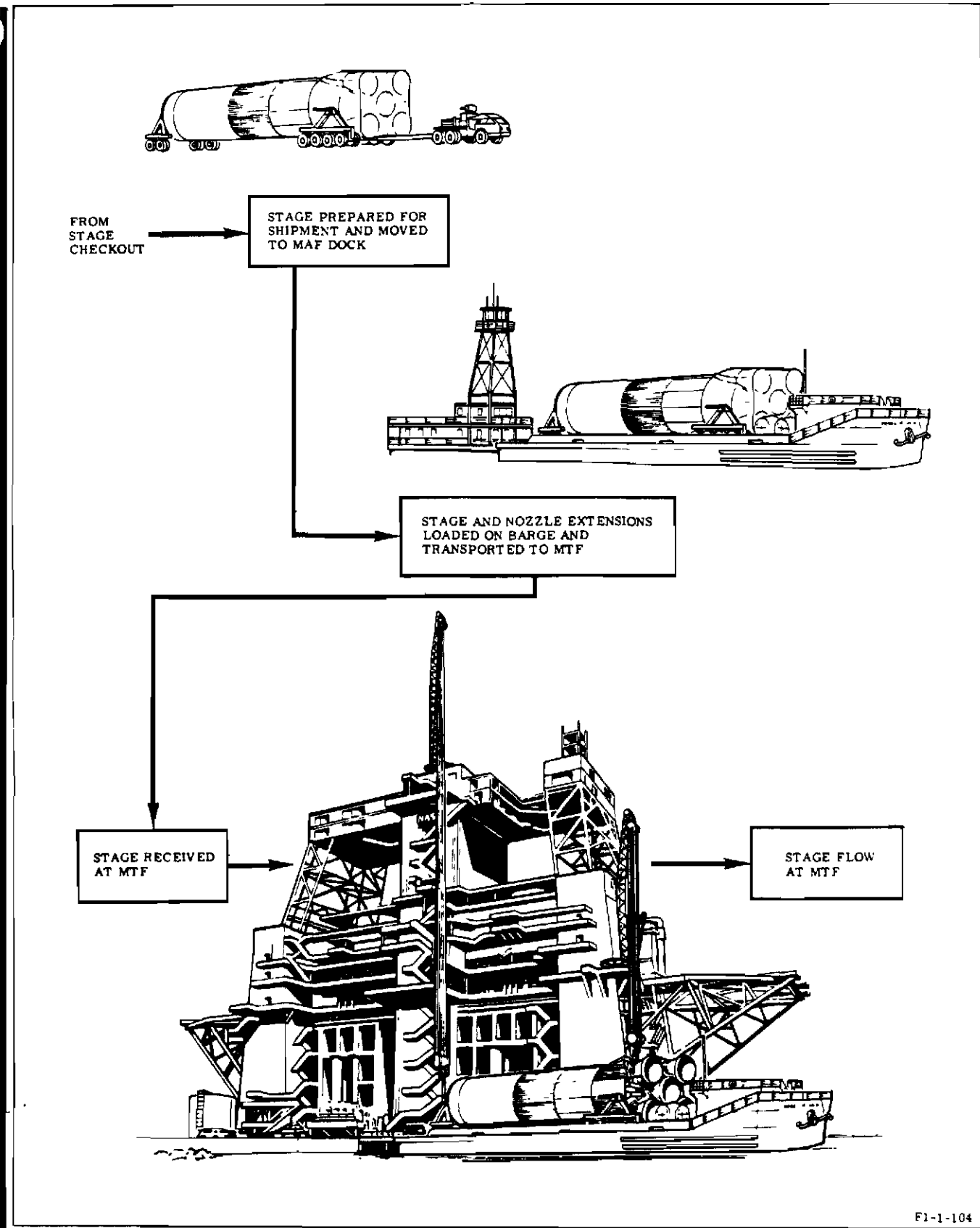

Figure 1-63. Engine Installation at MAF

are emptied and the quantity of fluid is measured. The turbopump preservation status is checked in the Engine Log Book, and the turbopump is serviced if required. A final updating of the Engine Log Book is made before engine shipment to MTF. Detailed procedures for inspecting the installed engine before shipment to MTF are in R-3896-11.

1-180. STAGE SHIPMENT TO MTF. (See figure 1-64.)

1-181. When installed-engine inspection is complete, the forward stage cover and engine covers are installed, the workstands and platforms are rolled away from the engines, a tractor is connected to the stage transporter,



F1-1-104

Figure 1-64. Stage Shipment to MTF

and the stage is pulled to the MAF dock. The stage is loaded onto the barge and secured. The nozzle extensions are loaded on low-bed trailers, towed to the MAF dock, loaded on the barge using a mobile hoist, and secured. The barge is then moved to MTF by tug.

1-182. STAGE FLOW AT MTF. (See figure 1-65.)

1-183. The stage is received at MTF and installed in the test stand. The engine covers are removed, and receiving inspection is performed. The nozzle extensions, slave hardware (normally stored at MTF), and MTF static test instrumentation are installed; then a pre-static checkout is performed. Thermal insulation is not required for static test, therefore it is not installed. Engine maintenance is done and modifications are made as required during engine flow at MTF. Upon completion of pre-firing preparations, the static firing test is performed. After static test, the engines are inspected; the test instrumentation, slave hardware, and nozzle extensions are removed; a pre-shipment inspection is performed; and the stage and nozzle extensions are removed from the test stand and loaded on the barge for return to MAF.

1-184. STAGE INSTALLATION IN TEST STAND.

1-185. When the stage arrives at MTF, the barge is docked next to the test stand. Test stand overhead cranes are attached to the forward and aft ends of the stage; the stage is lifted clear of the stage transporter and barge, rotated to the vertical position, and positioned into the test stand. During rotation to the vertical position, the thrust chamber and exhaust manifold are monitored for fuel leakage. The stage is secured to the test stand with mechanical holddowns; stage/facility propellant, hydraulic, pneumatic, and electrical connections are secured; and engine covers and engine oxidizer and fuel inlet screens are removed.

1-186. ENGINE RECEIVING INSPECTION.

1-187. After the stage is installed in the test stand, the engines undergo an overall visual receiving inspection. Each engine is inspected for damage, corrosion, and missing equipment and for evidence of fluid in drain line exits. It is verified that corrosion preventive and aluminum-foil tape is present in specified

areas, the engine soft goods installed life is within specified limits, and there are no voids in the turbopump housing cavity filler material. The fuel overboard drain system isolation polyethylene bags are visually inspected for fluid. If fluid is present, the bags are emptied and the quantity of fluid is measured. Engine orifice sizes and serialized components are checked against those listed in the Engine Log Book. Detailed inspection requirements for installed engines received at MTF are in R-3896-11.

1-188. INSTALLATION OF NOZZLE EXTENSIONS, SLAVE HARDWARE, AND MTF STATIC TEST INSTRUMENTATION.

1-189. The nozzle extensions, slave hardware, and MTF static test instrumentation are installed on the engines after the stage is installed in the test stand and after receiving inspection. Using Engine Handler Sling G4052 and overhead cranes, the nozzle extension is removed from the barge and from Nozzle Extension Handling Fixture G4080 and Handling Adapter G4081 and placed on Engine Vertical Installer G4049 on the lower stand work platform. The installer, with nozzle extension, is positioned below the engine; then the nozzle extension is installed on the engine, and the installer lowered. The polyethylene bags are removed from the fuel overboard drain system, and the slave fuel, oxidizer, and nitrogen overboard drain lines are installed. The slave igniter harness and MTF static test instrumentation are then installed and connected. Detailed installation requirements are in R-3896-11. Detailed nozzle extension handling requirements are in R-3896-9.

1-190. STAGE PRE-STATIC CHECKOUT.

1-191. The stage pre-static checkout is performed on all engine and stage systems. Immediately preceding pre-static checkout, Thrust Chamber Throat Security Closure G4089 is removed and Thrust Chamber Throat Plug G3136 is installed. The checkout consists of electrical, hydraulic, and pneumatic leak and function tests. A simulated static test, which simulates stage preparation, engine start, ignition, mainstage, and cutoff sequencing, is performed to verify stage acceptability for static test. Detailed pre-static checkout requirements are in R-3896-11.

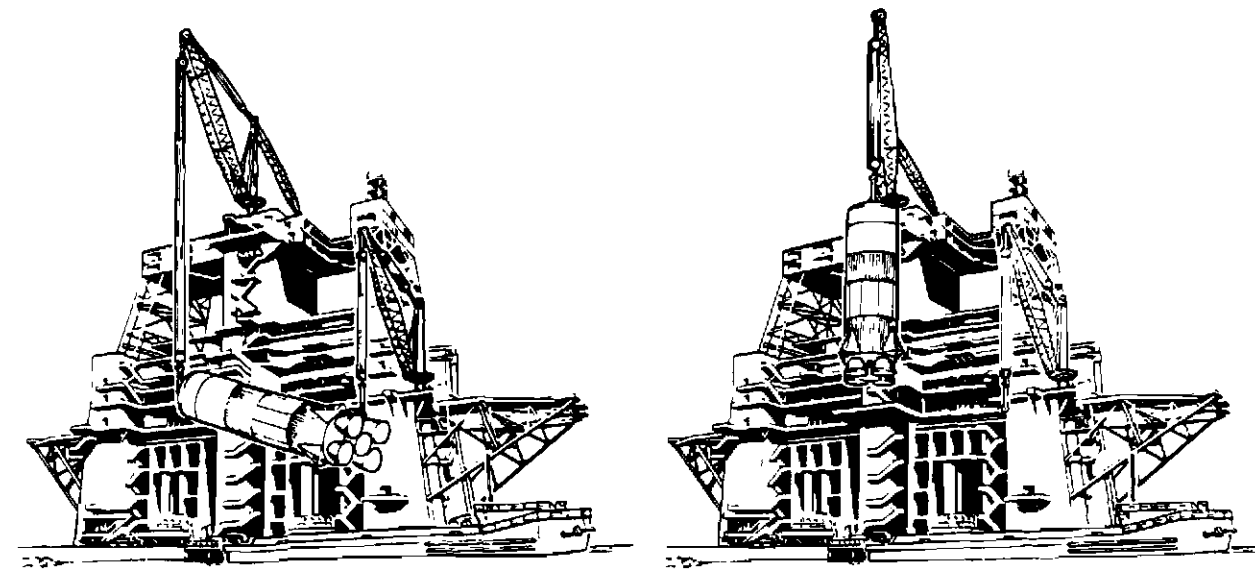

STAGE REMOVED FROM BARGE

STAGE AND NOZZLE EXTENSIONS INSTALLED IN TEST STAND AND STATIC FIRED

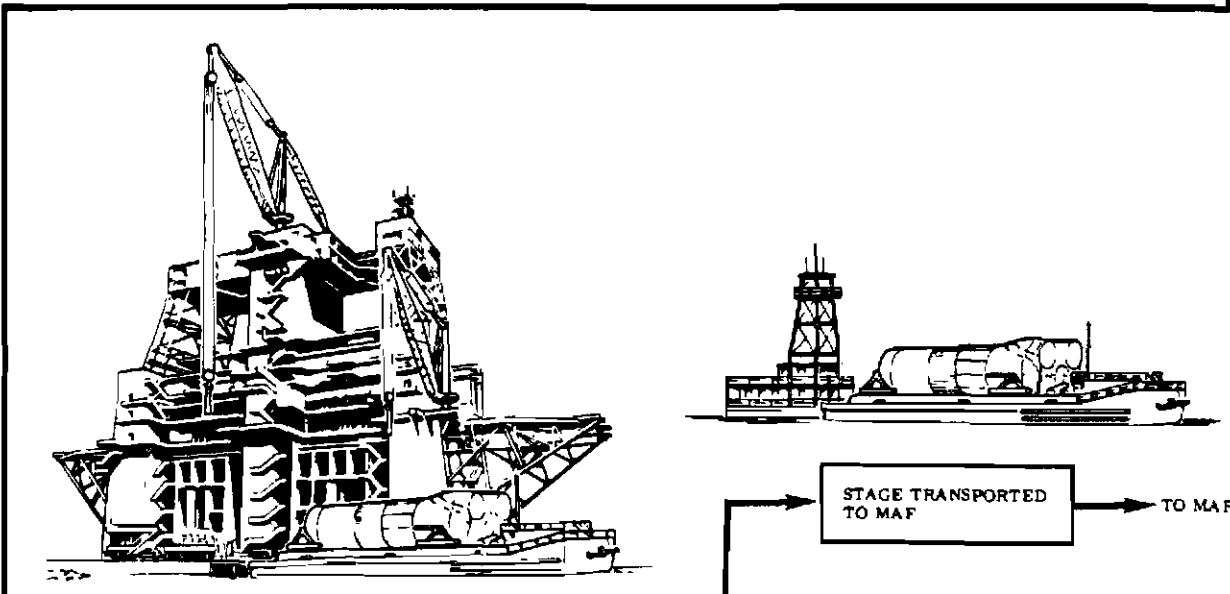

STAGE AND NOZZLE EXTENSIONS REMOVED FROM TEST STAND AND LOADED ON BARGE

STAGE TRANSPORTED TO MAF

TO MAF

F1-1-105

Figure 1-65. Stage Flow at MTF

1-192. STATIC TEST.

1-193. When all required checkout procedures, modifications, and maintenance are completed, and the Thrust Chamber Throat Plug G3136 is removed, the hypergol cartridge and pyrotechnic igniters are installed and checked out and the test area is cleared in readiness for static test. A 125-second, uninterrupted-duration stage static test is made to checkout all electrical-electronic, propulsion, mechanical, pressurization, propellant, and control systems that function during actual countdown, launch, and flight. Measurements of the static test are recorded and processed to determine stage acceptability and flight readiness. The engine start for the stage is a 1-2-2 sequence: the center engine starts first, and the remaining outboard engines start in opposed groups of two. The engine cut-off is a 3-2 sequence: the center engine and two opposite outboard engines cut off first; then the remaining two outboard engines cut off. The single-engine start and cutoff sequence flows are in figures 1-57 and 1-58.

1-194. ENGINE INSPECTION AFTER STATIC TEST.

1-195. The engine and nozzle extension are inspected visually after static test to verify that damage did not occur during the test. Detailed inspection requirements are in R-3896-11 and include inspecting for exterior damage and missing aluminum tape between thrust chamber exhaust manifold and thrust chamber tubes; inside of thrust chamber for tube and injector damage, injector contamination, and liquid leakage. Other inspections are for tension tie deformation, bent or broken studs, nozzle extension for carbon deposits around flange area, and internal damage and erosion.

1-196. STATIC TEST DATA REVIEW.

1-197. The static test data is reviewed after static test to determine that the engine is operating within specified limits. Test instrumentation readings are examined to detect abnormalities, sudden shifts, oscillations, or performance near the minimum or maximum limits.

1-198. TURBOPUMP PRESERVATION.

1-199. The turbopump is preserved within 72 hours after static test. After removing fluid through the turbopump No. 3 bearing drain line, the turbopump bearings are purged with gaseous nitrogen, and five gallons of preservative oil is supplied to the bearings while the turbopump is

slowly rotated. The fluid is then drained through the No. 3 bearing drain line, and the bearings are again purged with gaseous nitrogen. The preservation date is recorded in the Engine Log Book.

1-200. REMOVAL OF NOZZLE EXTENSIONS, SLAVE HARDWARE, AND MTF STATIC TEST INSTRUMENTATION.

1-201. Engine Vertical Installer G4049 is positioned below the nozzle extension and the nozzle extension removed from the engine and lowered onto the installer. Using Engine Handler Sling G4052 and overhead cranes, the nozzle extension is removed from the installer, installed on Nozzle Extension Handling Fixture G4080, and the loaded nozzle extension installed on Handling Adapter G4081. The slave hardware, consisting of fuel overboard drain lines and the igniter harness, is removed, cleaned, tested, and repaired or replaced, as required, for reuse during the next static test. The fuel overboard drain system is isolated using clean polyethylene bags. The expended igniters and hypergol cartridge are removed. The MTF static test instrumentation is disconnected and removed and the instrumentation ports plugged immediately by incorporating the applicable retrofit kit specified in Modification Instruction R-5266-391 (ECP F1-391). The Thrust Chamber Throat Security Closure G4089 is installed. Detailed removal requirements are in R-3896-11. Detailed nozzle extension handling requirements are in R-3896-9.

1-202. INSTALLED-ENGINE INSPECTION BEFORE STAGE SHIPMENT TO MAF.

1-203. The engine is inspected before shipment to MAF and after all post-static-test tasks are complete. Each engine is visually inspected for damage, corrosion, and missing equipment: for evidence of fluid in drain line exits or on the engine exterior; and for surface wetting on the hydraulic control system exterior. It is verified that corrosion preventive and aluminum-foil tape is present in specified areas, line markings are correct, the humidity indicator in the thrust chamber throat security closure indicates blue, and there are no voids in the turbopump housing cavity filler material. The fuel overboard drain system isolation polyethylene bags are visually inspected for fluid. If fluid is present, the bags are emptied and the quantity of fluid is measured. All engine protective closures are installed upon

ompletion of visual inspection. It is verified that the humidity indicator in the thrust chamber throat security closure indicates blue at the time of shipment. Detailed inspection requirements are in R-3896-11.

1-204. STAGE REMOVAL FROM TEST STAND.

1-205. After engine visual inspection, the engines and stage are prepared for removal from the test stand. The engine and stage covers are installed; stage/facility propellant, hydraulic, pneumatic, and electrical connections are disconnected; and mechanical holddowns are removed. Test stand overhead cranes are attached to the forward and aft ends of the stage; the stage is lifted clear of the test stand, rotated to the horizontal position, and installed on the stage handler on the barge. The oxidizer pump seal is purged during engine rotation to the horizontal position and for 30 minutes (minimum) thereafter. The nozzle extensions, installed on Nozzle Extension Handling Fixtures G4080 and Handling Adapters G4081, are removed by overhead crane and loaded on the barge. The stage transporter and nozzle extensions are secured on the barge for shipment. A final updating of the Engine Log Book is made before shipment to MAF.

1-206. STAGE SHIPMENT TO MAF.

1-207. The barge, containing the stage and nozzle extensions, is moved from MTF to MAF by tug. Upon arrival at the MAF dock, a tractor is connected to the stage transporter, and the stage is pulled from the barge and towed to the Stage Checkout Building. The nozzle extensions are loaded on low-bed trailers, using a mobile hoist, and towed from the barge to the nozzle extension storage area.

1-208. STAGE FLOW AT MAF. (See figure 1-66.)

1-209. The stage is positioned in the Stage Checkout Building at MAF, and workstands and platforms are installed to aid access during inspection and checkout. The engines undergo a receiving inspection, refurbishment, post-static checkout, and pre-shipment inspection. A storage period may be required after refurbishment, if so, the stage is prepared for storage and stored for a specified time before post-static checkout.

1-210. ENGINE RECEIVING INSPECTION.

1-211. After positioning the stage in the Stage Checkout Building, the engines undergo an overall visual receiving inspection. Each engine is inspected for damage, corrosion, and missing equipment and for evidence of fluid in drain line exits. It is verified that corrosion preventive and aluminum-foil tape is present in specified areas and that there are no voids in the turbopump housing cavity filler material. The fuel overboard drain system isolation polyethylene bags are visually inspected for fluid. If fluid is present, the bags are emptied and the quantity of fluid is measured. Engine orifice sizes and serialized components are checked against those listed in the Engine Log Book. It is verified that the humidity in the thrust chamber throat security closure indicates blue. Detailed inspection requirements for installed engines received at MAF are in R-3896-11.

1-212. ENGINE REFURBISHMENT.

1-213. The engine is refurbished after receiving inspection. The engines are first cleaned of any foreign matter and corrosion that may have resulted from exposure to rain, humidity, sand, or dust. The oxidizer dome insulator is installed in accordance with requirements specified in R-3896-6. The flight igniter harness is installed, tested, and connected in accordance with requirements specified in R-3896-11. Outstanding maintenance or modification, as required by ECPs and EFIRs, is done during the refurbishment period.

1-214. STAGE STORAGE.

1-215. Storage of installed engines is scheduled following completion of refurbishment. The amount of time the stage remains in storage is determined by the Saturn V vehicle launch schedule. Stage storage, in excess of six months, requires that engine post-static checkout be performed when the stage is removed from storage. Installed engines are visually inspected for damage, corrosion, and missing equipment, and for evidence of fluid in oxidizer and nitrogen purge overboard drain lines. It is also verified that corrosion preventive and aluminum-foil tape is present in specified areas, the gimbal boot is installed, there are no voids in the turbopump housing cavity filler material, and that fuel overboard drain system isolation polyethylene

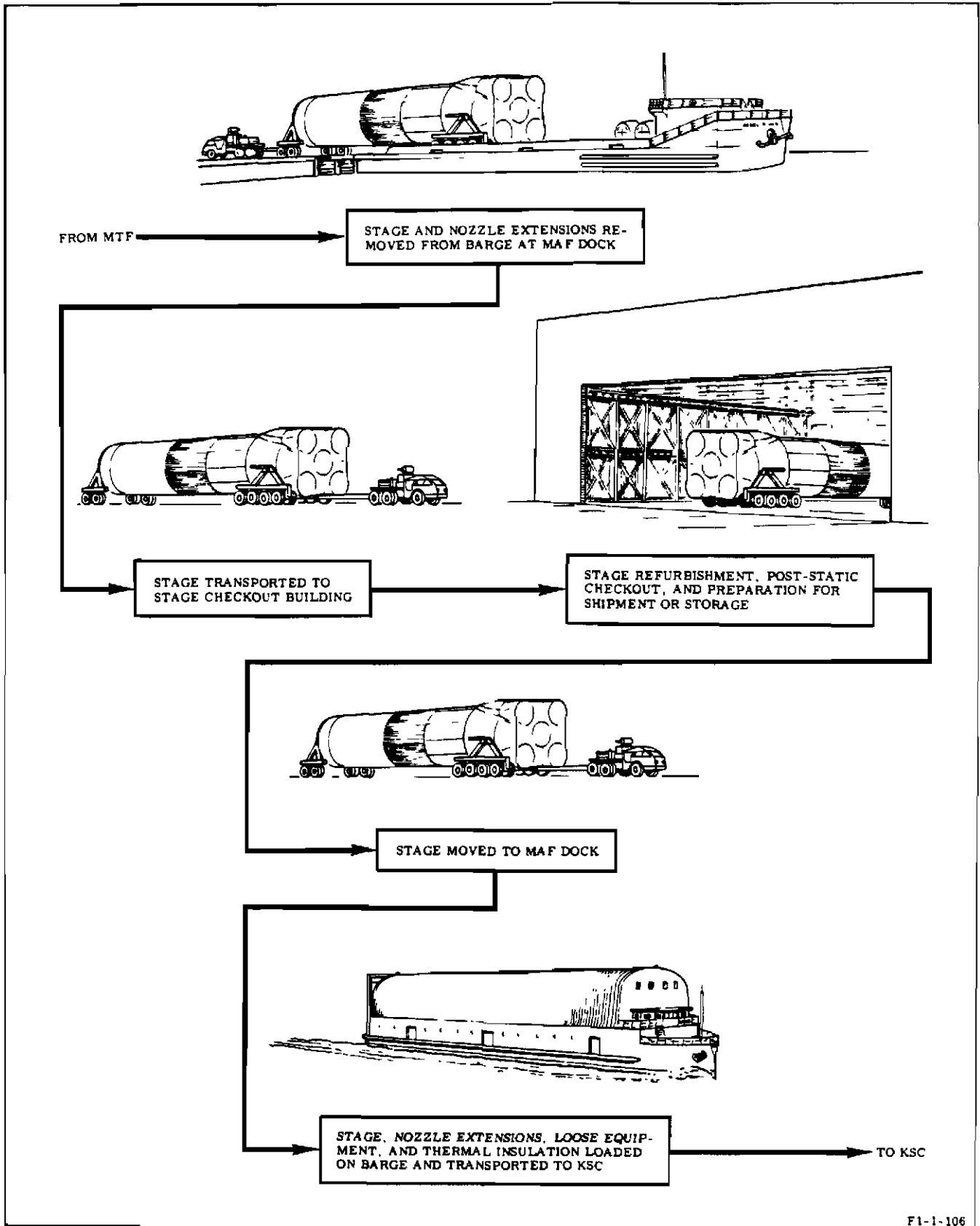

Figure 1-66. Stage Flow at MAF

bags do not contain fluid. If fluid is present, the bags are emptied and the quantity of fluid is measured. The turbopump preservation status is checked in the Engine Log Book and the turbopump is serviced if required; desiccants are installed in the thrust chamber throat security closure and the closure is installed; and humidity indicators are checked for a blue indication. The engine-to-stage gimbal actuators are locked to prevent engine movement, and the stage is stored in an environmentally controlled area. The engines are inspected periodically during storage. Detailed inspection requirements for installed engines in storage are in R-3896-11.

1-216. POST-STATIC CHECKOUT.

1-217. The post-static checkout is done after refurbishment tasks are completed, after a stage is removed from storage on which a post-static checkout had not been previously accomplished, or after stage storage has exceeded six months. The post-static checkout consists of complete electrical, hydraulic, and pneumatic leak and functional tests of the installed engines and stage systems. The post-static checkout is completed with a simulated launch test that consists of stage preparations, engine start, ignition, mainstage, liftoff, flight, and engine cutoff in the prescribed sequence to assure flight readiness of the engines and stage. Post-static checkout includes a flight instrumentation function test, turbopump torque test and heater function test, leak and function test of the bearing coolant control valve; hypergol manifold, thrust OK pressure switches, thrust chamber prefill line, ignition monitor valve, oxidizer dome and gas generator oxidizer injector purge system, oxidizer pump seal purge system, cocoon purge system, and hydraulic system. Leak test of the thrust chamber, heat exchanger helium and oxidizer systems, propellant fuel and oxidizer systems, exhaust system, and valve timing function tests are also accomplished. Engine start and cutoff flow sequences are in figures 1-57 and 1-58. Installed engine tests are conducted in accordance with requirements specified in R-3896-11.

1-218. INSTALLED-ENGINE INSPECTION BEFORE STAGE SHIPMENT TO KSC.

1-219. The installed engine is inspected before shipment to KSC and the Engine Log Book is reviewed after post-static checkout tasks are completed. Each engine is visually inspected

for damage, corrosion, and missing equipment; for evidence of fluid in drain line exits, fluid on the engine exterior; and for surface wetting on the hydraulic control system exterior. It is verified that corrosion preventive and aluminum-foil tape is present in specified areas, that line markings are correct, that the humidity indicator in the thrust chamber throat security closure indicates blue, and that turbopump housing cavity filler material does not contain voids. The fuel overboard drain system isolation polyethylene bags are visually inspected for fluid. If fluid is present, the bags are emptied and the quantity of fluid is measured. The turbopump preservation status is checked in the Engine Log Book, and the turbopump is serviced if required. A final updating of the Engine Log Book is made before engine shipment to KSC. Detailed procedures for inspecting the installed before shipment to KSC are in R-3896-11.

1-220. STAGE SHIPMENT TO KSC.

1-221. After the engine pre-shipment visual inspection is completed, the forward and aft stage covers are installed, workstands and platforms removed, and the stage pulled from the Stage Checkout Building to the MAF dock for transport to KSC by barge. The nozzle extensions, engine loose equipment, and thermal insulation are loaded on low-bed trailers and transported to the MAF dock where they are removed from the trailers and loaded on the barge and secured for shipment. Handling requirements for nozzle extensions and loose equipment are in R-3896-9. After the nozzle extensions, loose equipment, and thermal insulation boxes are loaded and secured, the stage is loaded onto the barge and secured. The barge is then moved to KSC by tug.

1-222. STAGE FLOW AT KSC. (See figure 1-67.)

1-223. The barge arrives at the KSC dock where the stage, nozzle extensions, loose equipment, and thermal insulation boxes are off-loaded. The stage is towed from the dock to the Vertical Assembly Building (VAB). The nozzle extensions, loose equipment, and thermal insulation boxes are loaded on low-bed trailers and transported to the VAB. The stage is removed from the stage transporter and erected onto the Launch Umbilical Tower (LUT) where the engine visual receiving inspection, loose equipment installation, modification and maintenance, stage and engine leak and functional tests, and thermal

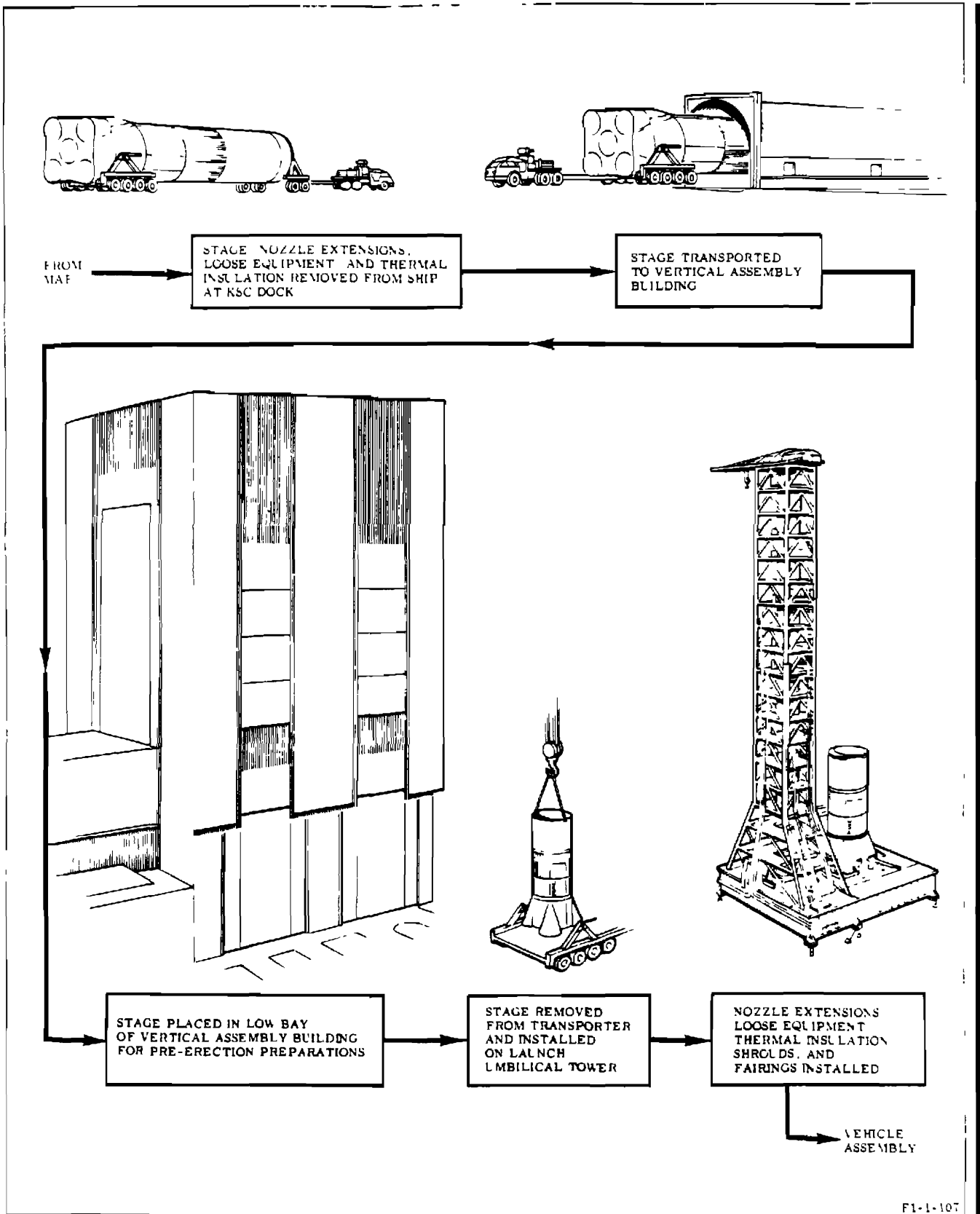

Figure 1-67. Stage Flow at KSC

insulation installations are accomplished. These tasks are conducted concurrently with the Saturn V vehicle assembly and testing. A final updating of the Engine Log Book is made after engine activities during stage flow are complete.

1-224. STAGE INSTALLATION ONTO LAUNCH UMBILICAL TOWER (LUT).

1-225. The stage is received in the low bay of the VAB. The forward and aft stage covers are removed and the stage and engines prepared for rotation and installation onto the LUT. The Engine Service Platform (ESP) and the LUT are moved into the high bay. The stage, on the transporter, is moved from the transfer aisle to the erection bay where the stage is removed from the transporter and rotated to the vertical position by overhead cranes. The stage is then moved by high bay crane and erected on the LUT and secured with four mechanical holdowns. The ESP and LUT level platforms are positioned around the engines for receiving inspection.

1-226. ENGINE RECEIVING INSPECTION.

1-227. After the stage is installed onto the LUT, protective closures are removed and the engines undergo an overall visual receiving inspection. The engines are inspected to verify that damage did not occur during shipping and that all equipment listed on shipping documentation was received. Each engine is inspected for damage, corrosion, and missing equipment; for evidence of fluid in drain line exits, fluid on the engine exterior, and for surface wetting on the hydraulic control system exterior. It is verified that corrosion preventive and aluminum-foil tape is present in specified areas, the engine soft goods installed life is within specified limits, there are no voids in the turbopump housing cavity filler material, and that turbopump and outrigger arm surfaces do not contain scratches through paint. The fuel overboard drain system isolation polyethylene bags are visually inspected for fluid. If fluid is present, the bags are emptied and the quantity of fluid is measured. Engine orifice sizes and serialized components are checked against those listed in the Engine Log Book. Oxidizer and fuel high-pressure duct covers and thrust chamber covers are installed after visual inspection completion. Detailed inspection requirements for installed engines received at KSC are in R-3896-11.

1-228. LOOSE EQUIPMENT INSTALLATION.

1-229. The engine loose equipment is installed after engine receiving inspection is completed. The loose equipment consists of the nozzle extension, oxidizer overboard drain line, fuel overboard drain line, nitrogen purge overboard drain line, and fuel inlet elbow-to-interface boots. Using Engine Handler Sling G4052 and overhead cranes, the nozzle extension is removed from Nozzle Extension Handling Fixture G4080 and Handling Adapter G4081 and placed on the Nozzle Extension Installer. The five nozzle extensions and Nozzle Extension Installers are placed on the Engine Service Platform in their respective engine positions. The Engine Service Platform is then raised from ground level up through the opening in the LUT until the nozzle extension flanges are approximately 5 inches below the thrust chamber exit flanges. Final adjustments are made and the mating of the extension flanges to the thrust chamber exit flanges is done with the individual Nozzle Extension Installers. After the nozzle extensions are secured to the engines, the overboard drain lines are attached and secured. Loose equipment is installed in accordance with requirements specified in R-3896-11. Detailed nozzle extension handling requirements are in R-3896-9. The stage fins and engine shrouds are installed in accordance with stage contractor requirements.

1-230. MODIFICATION AND MAINTENANCE.

1-231. The engine modifications and special inspections may be made and maintenance tasks may be performed, if required, throughout the stage flow at KSC. Modifications and special inspections are made as a result of approved ECP or EFIR action, and scheduled through joint agreement between the customer, stage contractor, and engine contractor. The engine maintenance is performed, if required, as a result of discrepant hardware noted during receiving inspection or engine leak and functional testing.

1-232. STAGE FUNCTIONAL TEST.

1-233. The stage functional testing is started after stage installation onto the LUT. The electrical, hydraulic, and pneumatic leak and functional tests are made in conjunction with vehicle assembly. The stage functional test consists of a flight instrumentation function test, turbopump torque test and heater function test, engine sequence verification test, leak and

function test of the bearing coolant system, hypergol manifold, thrust OK pressure switches, thrust chamber prefill line, ignition monitor valve, oxidizer dome and gas generator oxidizer injector purge system, oxidizer pump seal purge system, cocoon purge system, and hydraulic system. A leak test of the thrust chamber, heat exchanger helium and oxidizer systems, propellant fuel and oxidizer systems, exhaust system, and valve timing function tests is also performed. Installed engine tests are performed in accordance with requirements specified in R-3896-11.

1-234. THERMAL INSULATION INSTALLATION.

1-235. The thermal insulation (TIS) is installed after engine leak and functional testing is complete. The TIS is installed to completely envelop the engine and provide protection from extreme temperatures created by plume radiation and backflow during cluster engine flight. To allow access for verifying the integrity of engine components and systems and to prevent possible insulator damage from fluid spillage, the TIS is not installed until engine testing is complete. The required sequence and methods for TIS installation is in R-3896-6. After the thermal insulation is installed and before moving the Saturn V vehicle from the VAB, an engine environmental cover is installed on each S-IC engine, from the thrust chamber throat area to the exit end of the nozzle extension, to protect the thermal insulation from inclement weather. The cover is wrapped around the thrust chamber and nozzle extension and placed so that engine overboard drain lines are exposed through holes provided in the cover, and access flaps, four places, are located to provide access to drain ports and igniters. Overlapping edges of the cover are laced together, excess material is gathered around the thrust chamber throat and folds tied, and the cover drawn tight under exit end of nozzle extension. Detailed requirements for installation of the cover are in R-3896-11.

1-236. SATURN V VEHICLE FLOW AT KSC. (See figure 1-68.)

1-237. While the S-IC Stage is being received and erected in the VAB, the S-II Stage, S-IVB Stage, and Instrumentation Unit are received in the VAB and placed in the checkout bays where they undergo a complete pre-erection checkout. Upon completion of S-IC Stage erection, the Saturn V Vehicle assembly is started,

concurrently with S-IC Stage testing. When the fins, fairings, engine shrouds, and nozzle extensions are installed, the S-IC Stage assembly is complete. The Instrumentation Unit is moved into the high bay, placed on a platform near the S-IC Stage, and an S-IC Stage-Instrumentation Unit-checkout is performed. Upon completion of pre-erection checkout, the S-II Stage is moved from the checkout bay to the high bay and mated with the S-IC Stage. The S-IVB Stage is moved from the checkout bay and mated with the S-II Stage, and the Instrumentation Unit is removed from the platform and mated with the S-IVB Stage, completing the assembly of the Launch Vehicle (LV). After individual modules are checked out at the Manned Spacecraft Operations Building (MSOB), the Apollo spacecraft, consisting of the mated lunar excursion, and service and command modules, is moved into the VAB and mated mechanically (lunar excursion module-adaptor to forward mating flange of instrumentation unit).

1-238. VEHICLE TESTING.

1-239. After the Apollo spacecraft and launch vehicle are mechanically mated, spacecraft modules are connected to their umbilicals from the umbilical tower of the mobile launcher and pre-power-on tests are made. When it has been determined that all flight and ground systems are satisfactory, full power is applied to the spacecraft. The spacecraft is then mated electrically to the launch vehicle and combined system tests, consisting of simulated countdowns and flights that exercise both flight and ground systems, are made. During the final combined system testing phase, the spacecraft and launch vehicle ordnance, minus pyrotechnics, are installed including the launch escape system. When the combined system testing is complete, the test data is reviewed, and if acceptable, the Saturn V vehicle is ready to be moved to the launch pad.

1-240. TRANSFERRING VEHICLE TO LAUNCH PAD.

1-241. The Apollo/Saturn V is transported from the VAB to the launch pad by the crawler transporter. The extendible platforms that enclosed the vehicle in the VAB are retracted, connections between the mobile launcher terminals and the terminals in the high bay are disconnected, the doors of the high bay are opened, and the transporter brought in and

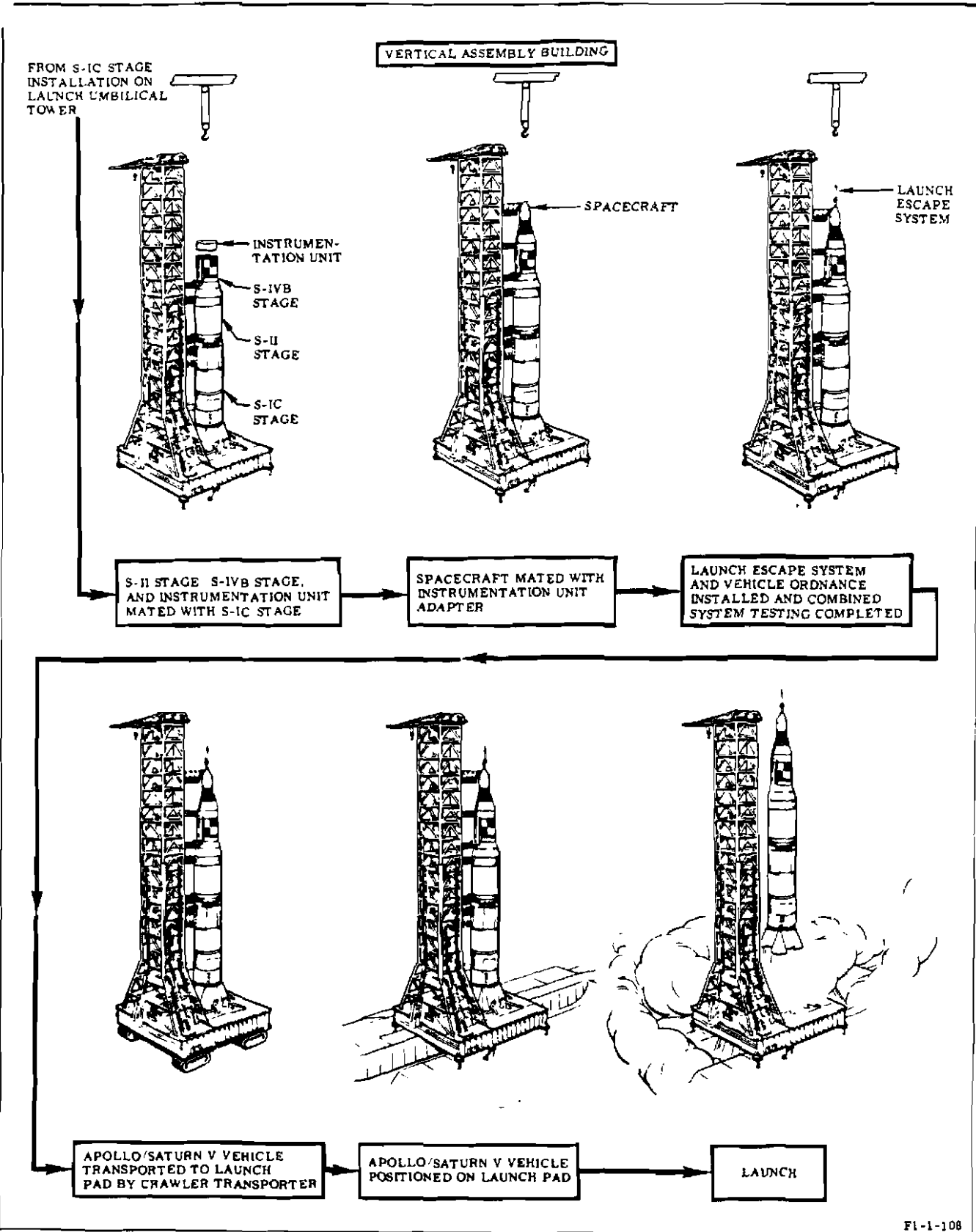

Figure 1-68. Saturn V Vehicle Flow at KSC

positioned beneath the platform section of the launcher. Hydraulic jacks are extended from the transporter to lift the launcher clear of its pedestals. Then, at a speed of approximately 1 mph, the transporter carries the launcher and the fully assembled Apollo/Saturn V to the launch pad for positioning.

1-242. LAUNCH PREPARATIONS AND TESTING.

1-243. After all electrical and pneumatic lines to the Apollo/Saturn V are reconnected through terminals at the base of the mobile launcher, and propellant lines, also connected through the launcher, are verified as correct, and it has been ascertained that no changes have occurred in the vehicle since it left the VAB, tests are made on the communication links to the vehicle. Measurements are also taken on systems such as the cutoff abort unit, radio-frequency, tank pressurization, and launch vehicle stage propellant utilization system. A Flight Readiness Test (FRT), backup guidance system test, and S-IC fuel jacket/oxidizer dome flush and purge are performed. Hypergolic propellants are loaded in the spacecraft tanks, RP-1 fuel is loaded in the launch vehicle tanks, and Countdown Demonstration Tests (CDDT) are performed. Liquid oxygen and liquid hydrogen are loaded into the launch vehicle during the last few hours of the countdown.

1-244. SATURN V VEHICLE LAUNCH.

1-245. The data in this paragraph is only used to describe a typical vehicle launch and is not intended to represent actual launch data. With S-IC stage engines and launch vehicle preparations complete, the S-IC engines are fired, all hold-down arms are released, and the vehicle committed for liftoff. The vehicle rises nearly vertically from the launch pad, for approximately 450 feet, to clear the launch umbilical tower. During liftoff, a yaw maneuver is executed to provide tower clearance in the event of adverse wind conditions or deviations from nominal flight. After clearing the tower, a tilt and roll maneuver is initiated to achieve the flight attitude and proper orientation from the selected flight azimuth. The S-IC center engine cutoff occurs at 2 minutes 5.6 seconds after first vehicle motion to limit the vehicle acceleration to a nominal 3.98 G-load. The S-IC outboard engines are cutoff at 2 minutes 31 seconds after first vehicle motion. Following S-IC

engines cutoff, ullage rockets are fired to seat S-II stage propellants, the S-IC/S-II stages separate, and retrorockets back the S-IC stage away from the flight vehicle. A time interval of 4.4 seconds elapses between S-IC engines cutoff and the time the S-II engines reach 90 percent operating thrust level. Following the programmed burn of S-II engines, the S-II/S-IVB stages separate and the S-IVB engine places the flight vehicle in an earth parking orbit.

1-246. POST-FLIGHT DATA EVALUATION.

1-247. The post-flight data is evaluated to determine that the S-IC stage engines operated within the specified values during vehicle launch. The engine parameters are reviewed for abnormalities, sudden shifts, oscillations, or performance near the minimum or maximum limits. The engine performance values are then reviewed and compared to the predicted engine values to determine that all engine objectives were satisfactorily met.

1-248. UNSCHEDULED MAINTENANCE FLOW.

1-249. Unscheduled maintenance consists of those operations required in addition to normal engine and hardware processing, to repair damage, replace discrepant components or hardware, perform modifications and EFIRs, decontaminate, re-preserve, repair thermal insulation, or rectify any unsatisfactory condition. The unscheduled maintenance tasks are done at a specified time and at the location designated, during the normal engine flow process. The locations where unscheduled maintenance can be done are Rocketdyne, MAF, MTF, or KSC; depending on the extent of the task, urgency, capabilities of the location, and how schedules are affected. The location established for complete component maintenance, repair, and testing is the CM&R room at MAF. This facility provides component maintenance support for MAF, MTF, and KSC. Limited repairs on components can be made in-place on the engine at MAF, MTF, or KSC as directed by the customer. The necessary hardware required for supporting engine and component repairs at field locations is stored and maintained at MAF.

1-250. UNSCHEDULED ENGINE REPAIR AND SERVICING.

1-251. Unscheduled engine repair and servicing consists of various types of repairs and servicing

tasks that are done whenever practical to correct any discrepancies that may exist, perform special inspections, and to update the engine configuration. The various repairs and servicing tasks may include such items as: braze and weld repair thrust chamber tubes, remove and replace components, clean contaminated areas, remove corrosion, touch-up of damaged surface finishes, modifications, EFIRs, post-maintenance tests, lubricate, preserve, and replace desiccants.

1-252. COMPONENT REPAIR.

1-253. Uninstalled engine components from MAF, MTF, or KSC that require repair, modification, analysis or testing are processed in the environmentally controlled CM&R room at MAF. Processing engine components in the CM&R room is required to repair a discrepant component from an engine, perform modifications, failure analysis, inspections, recycle testing, or pre-installation testing. After processing in the CM&R room, the components are designated to be installed on an engine, returned to the engine support hardware center as a spare, returned to the manufacturer, or considered as surplus or scrap. Detailed procedures for component maintenance and repair are in R-3896-3.

1-254. SUPPORT HARDWARE.

1-255. Engine hardware required for supporting the activities at MAF, MTF, and KSC is maintained in the Engine Support Hardware Center at MAF. The Michoud facility is the primary hardware supply center, since the majority of engine and component activity takes place at this location. At MTF and KSC a limited inventory of hardware is maintained to make sure of immediate availability of those items frequently used at these locations. Whenever an urgent need arises at either MTF or KSC, and the hardware required is not locally available, the item is expedited to that location directly from MAF or Rocketdyne.

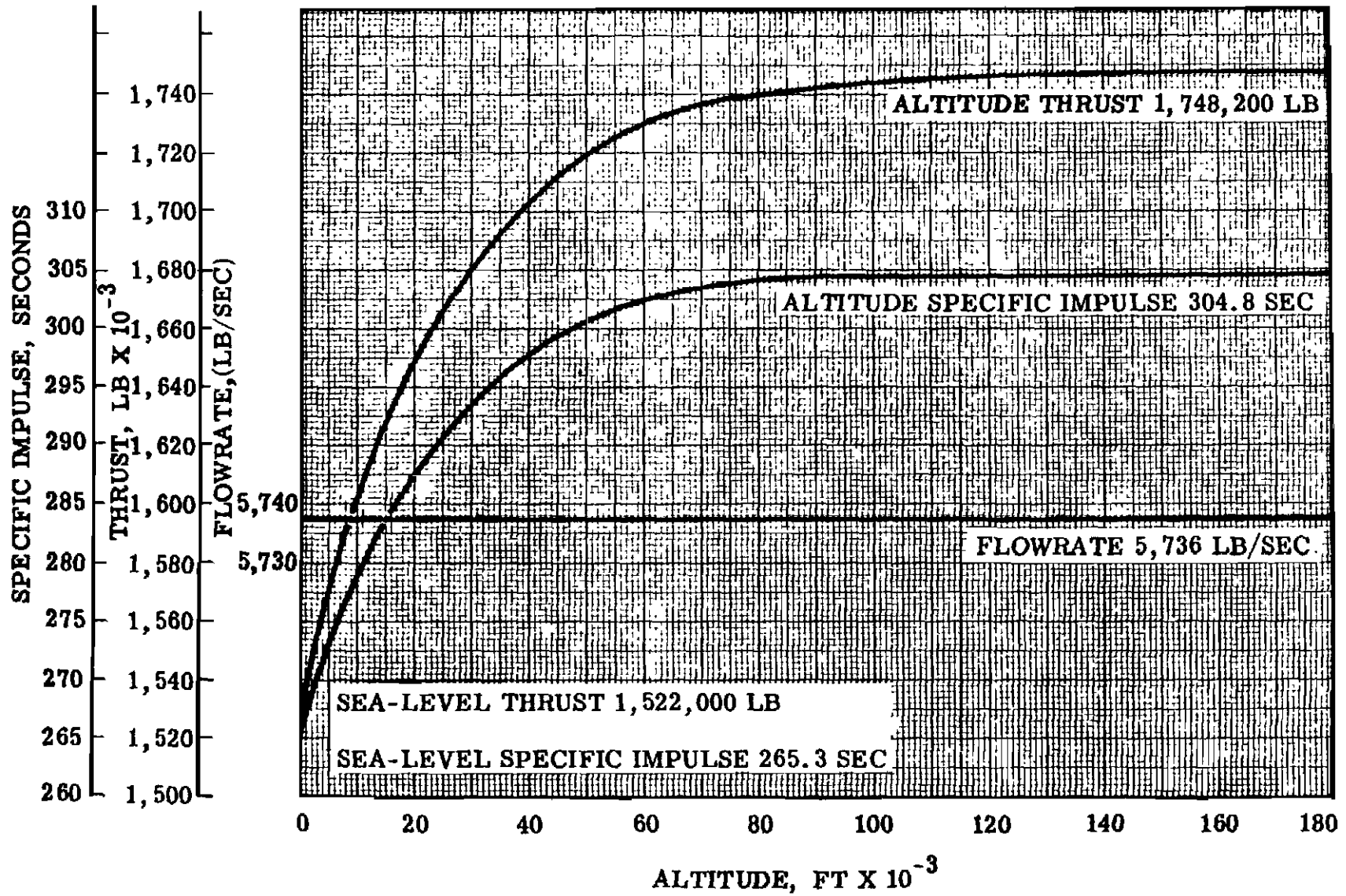

F1-1-31A

Figure 2-3. Nominal Altitude Performance

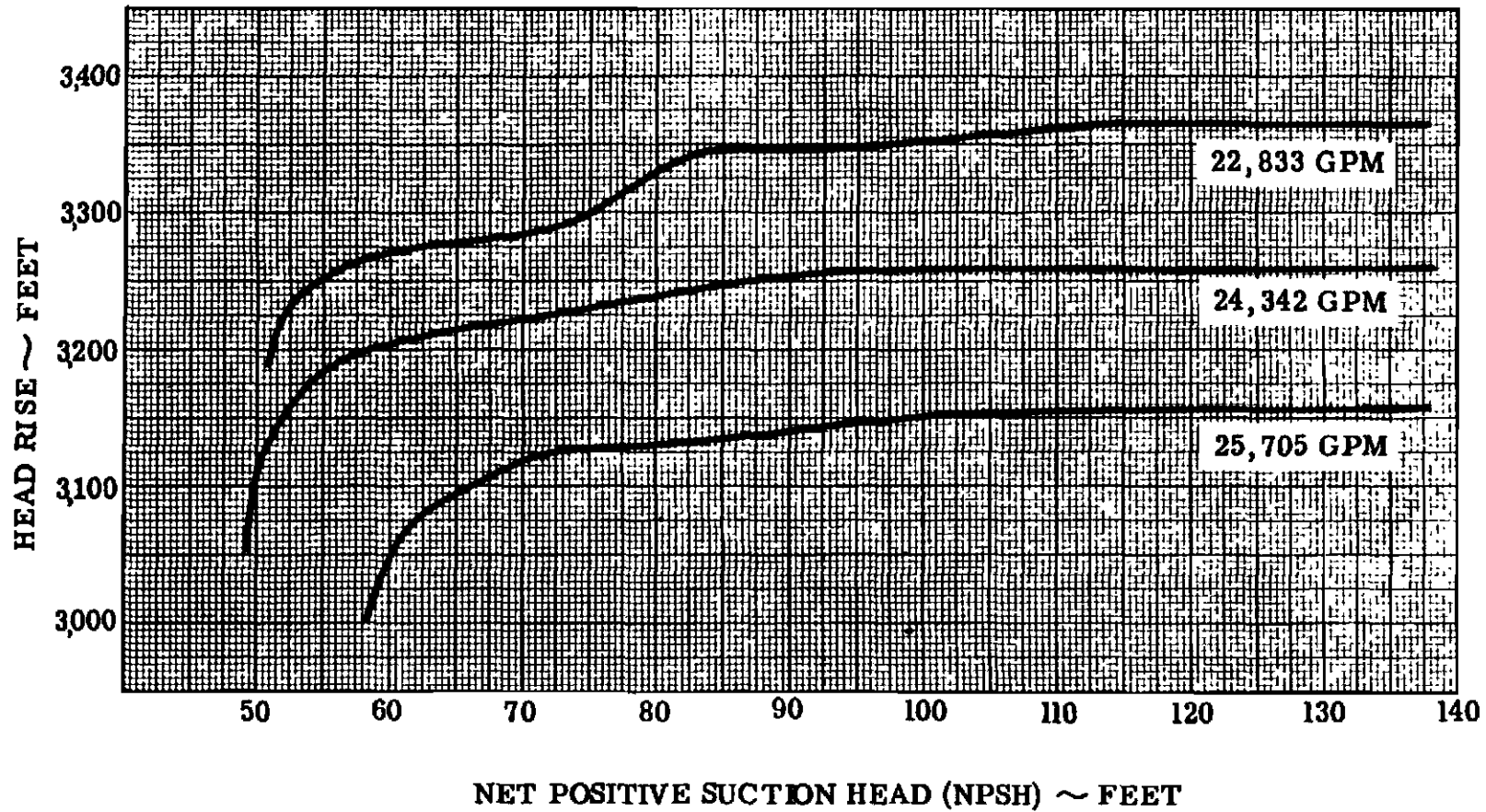

CURVE SPEED = 5550 RPM
IMPELLER DIAMETER = 19.500 INCHES
AVERAGE INLET FLUID TEMPERATURE = -295.5 °F

104001-G-18D

Figure 2-4. Oxidizer Pump Cavitation Characteristics

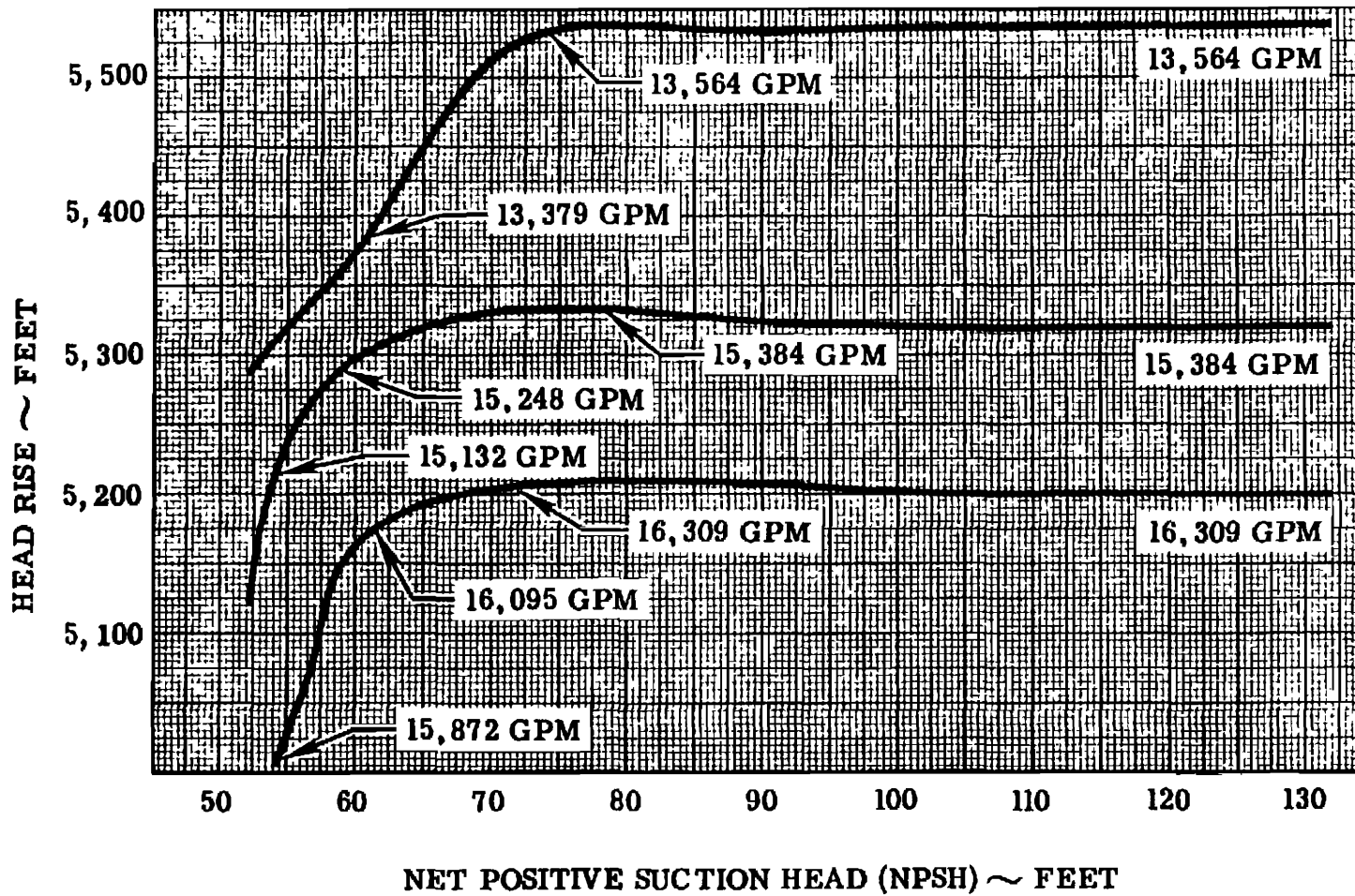

CURVE SPEED = 5,550 RPM
IMPELLER DIAMETER = 22,850 INCHES
AVERAGE STARTING INLET FLUID TEMPERATURE = 80.0°F

104001-G-11 E

Figure 2-5. Fuel Pump Cavitation Characteristics

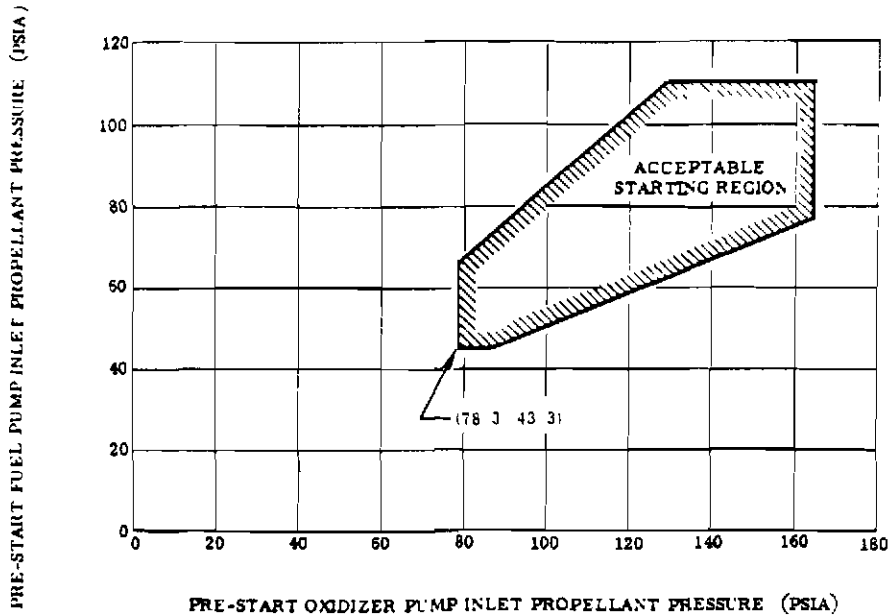

FI-11-134

Figure 2-6. Acceptable Pump Inlet Propellant Pressures for Starting Engine

2-14. HEAT EXCHANGER PERFORMANCE.

2-15. See figure 2-7 for heat exchanger flow-rate values. See figures 2-8 and 2-9 for helium and oxidizer temperatures versus flow and accumulated engine test duration curves. See figures 2-9A through 2-9M for heat exchanger transient and steady-state performance characteristics at constant turbopump inlet conditions.

2-16. HYDRAULIC CONTROL SYSTEM NOMINAL FLOW AND PRESSURE VALUES.

2-17. See figure 2-10 for hydraulic flowrate at nominal control system values.

2-18. ENVIRONMENTAL CONDITIONS.

2-19. STORAGE AND HANDLING TEMPERATURE.

2-20. The engine will not suffer detrimental effects when exposed to an ambient temperature range of -20° to +130° F at a relative humidity of 95 percent during handling and transportation operations and extended storage periods.

| Parameter | Value |
|-----------------|--------------------|
| Oxygen Flowrate | 3.0 to 15.0 lb/sec |
| Helium Flowrate | 0.4 to 1.0 lb/sec |

Figure 2-7. Heat Exchanger Flowrates

2-21. STORAGE AND HANDLING ATTITUDE.

2-22. The engine will not suffer detrimental effects when the engine attitude is maintained at less than 90 degrees from the normal vertical attitude (thrust chamber down) during handling and transportation operations, extended storage periods, and those maintenance tasks outlined in R-3896-3.

2-23. STANDBY EXPOSURE.

2-24. The engine with or without thermal insulation installed, when supplied with required operating fluids, electrical power, and fuel propellant only, will not suffer detrimental effects when exposed to an ambient temperature range of 0° to 130° F for 48 hours, except as limited by the freezing point of the thrust chamber prefill fluid.

Pages 2-6A and 2-6B deleted.

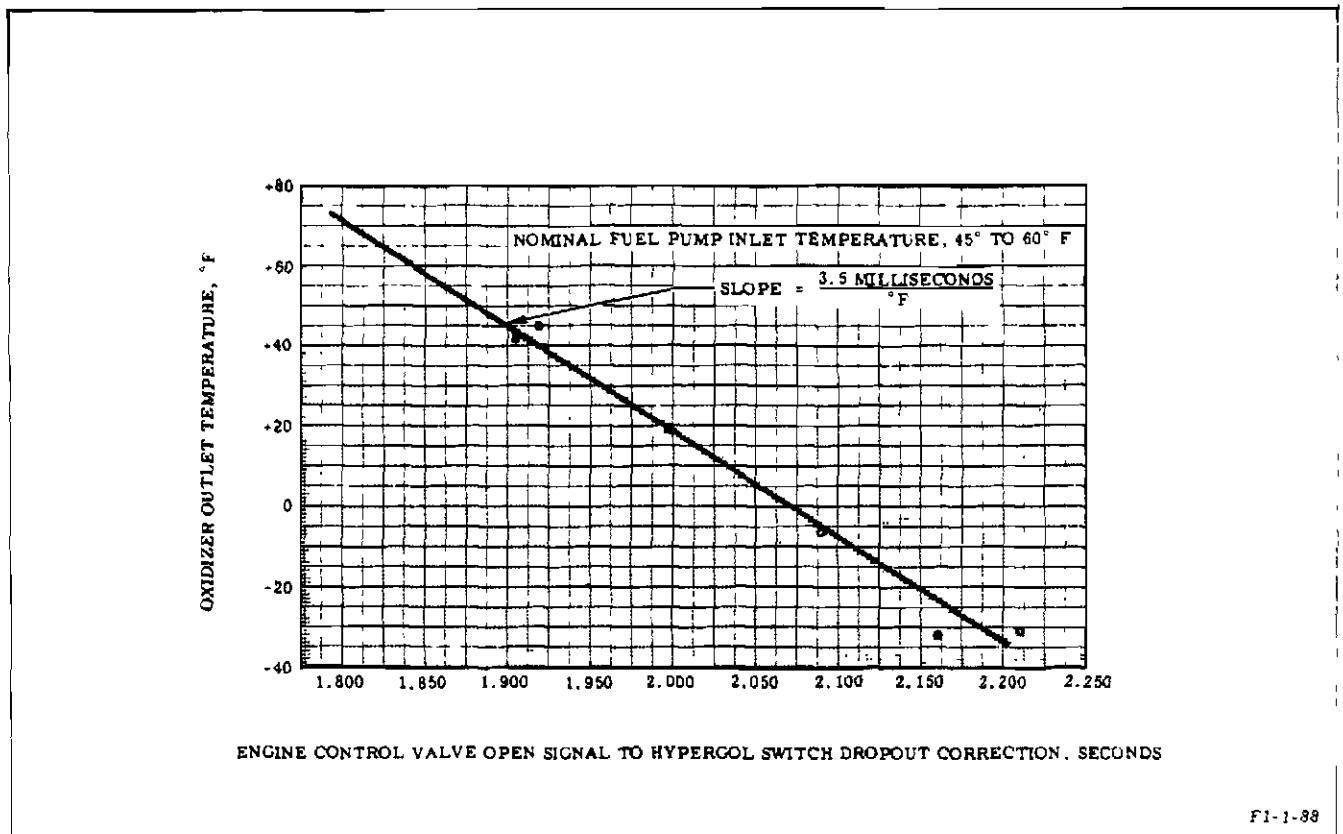

Figure 2-6A. Change in Start Time Versus Fuel Pump Inlet Temperature

| Parameter | Value |
|-----------------|--------------------|
| Oxygen Flowrate | 3.0 to 10.0 lb/sec |
| Helium Flowrate | 0.5 to 0.7 lb/sec |

Figure 2-7. Heat Exchanger Flowrates

2-21. STORAGE AND HANDLING ATTITUDE.

2-22. The engine will not suffer detrimental effects when the engine attitude is maintained at less than 90 degrees from the normal vertical attitude (thrust chamber down) during handling and transportation operations, extended storage periods, and those maintenance tasks outlined in R-3896-3.

2-23. STANDBY EXPOSURE.

2-24. The engine with or without thermal insulation installed, when supplied with required operating fluids, electrical power, and fuel propellant only, will not suffer detrimental effects when exposed to an ambient temperature range of 0° to 130° F for 48 hours, except as limited by the freezing point of the thrust chamber prefill fluid.

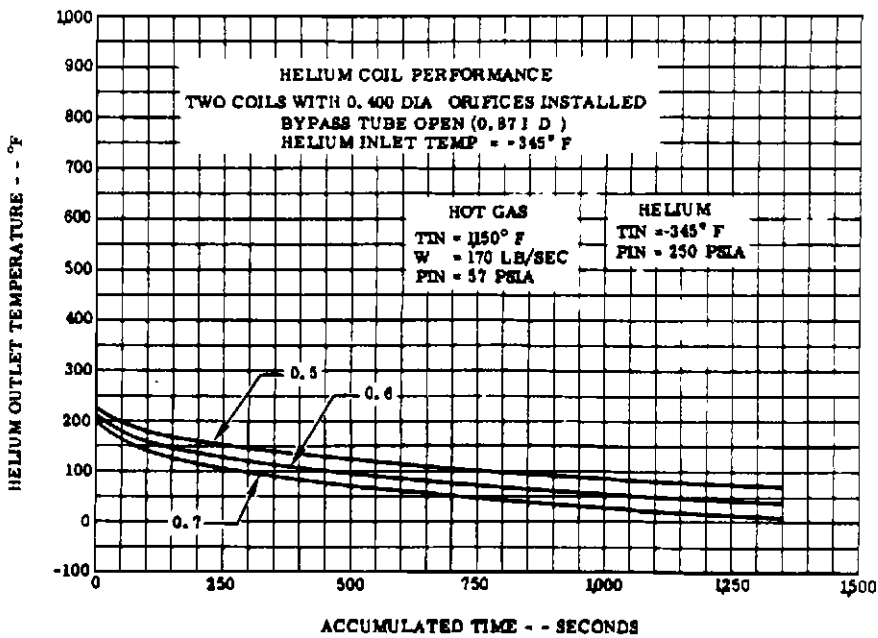
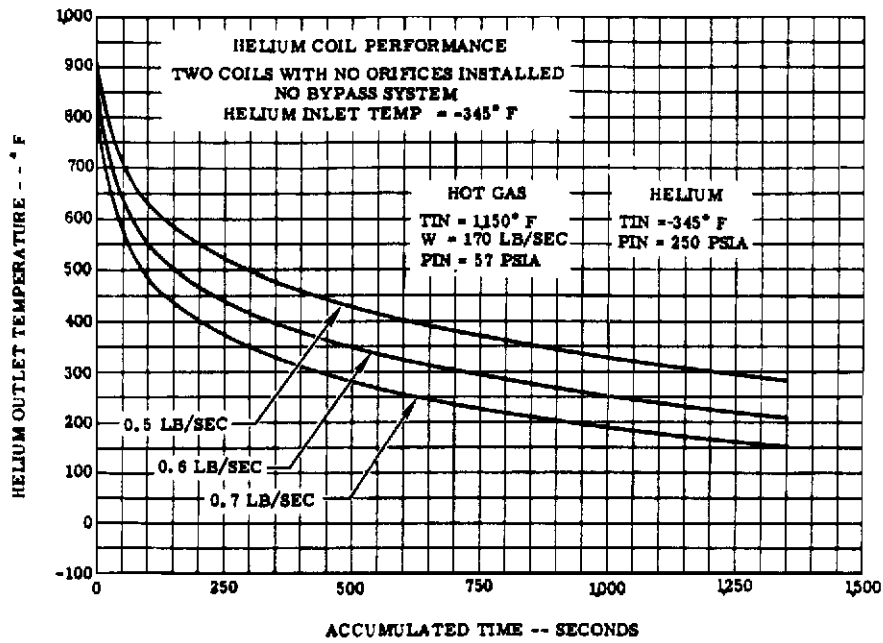

104001-G-32B

Figure 2-8. Helium Temperature Versus Flow and Accumulated Engine Test Duration Curve

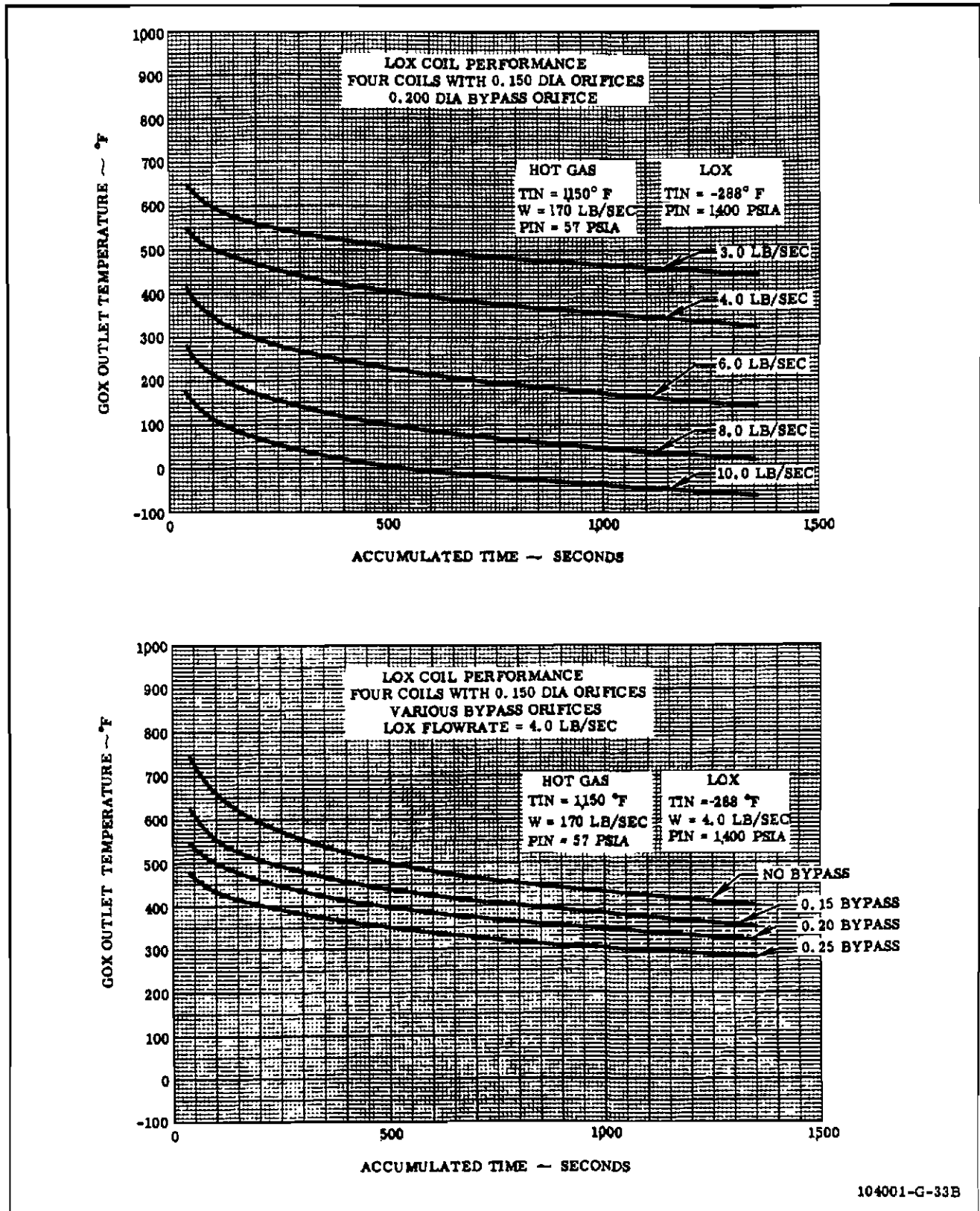
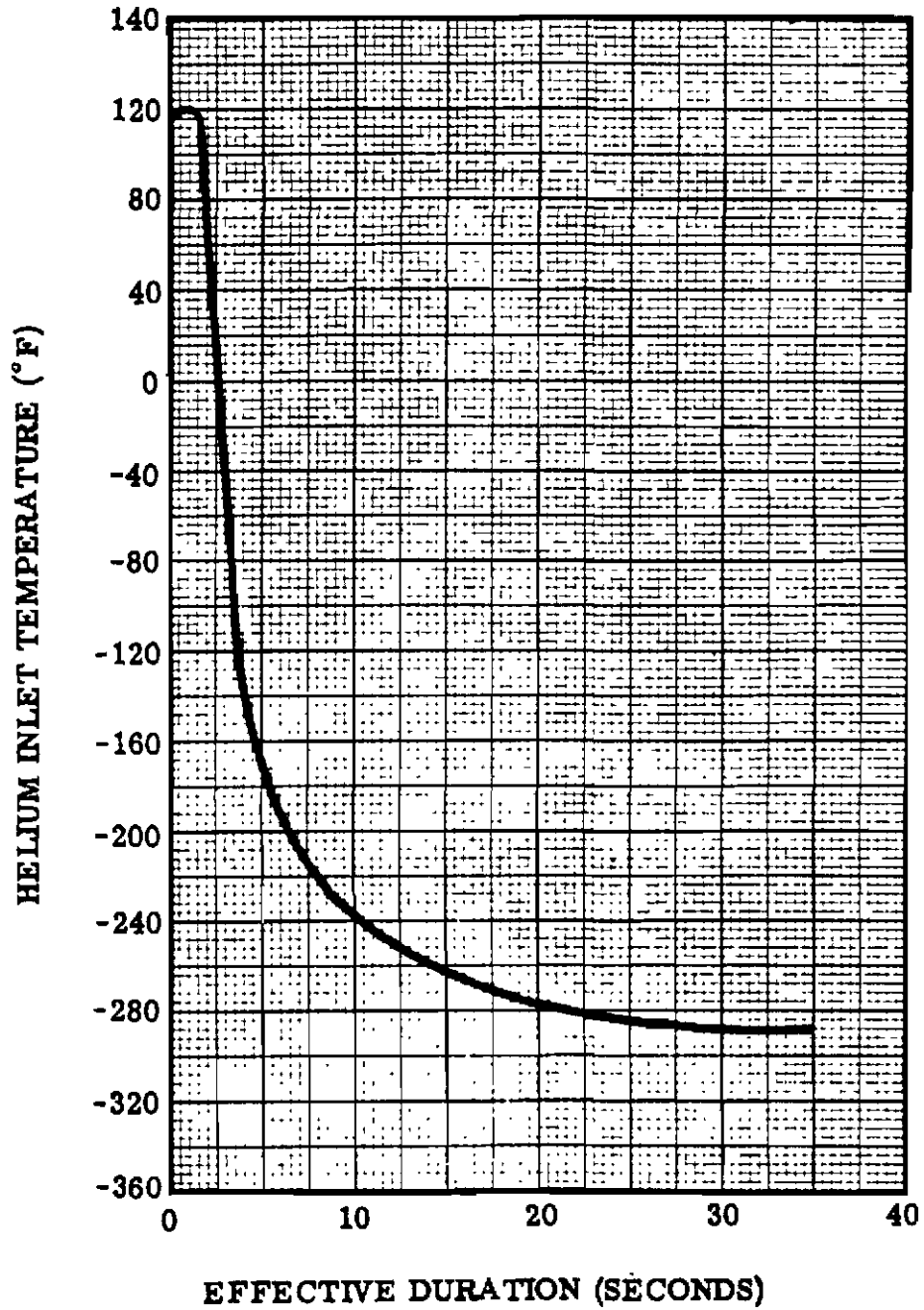
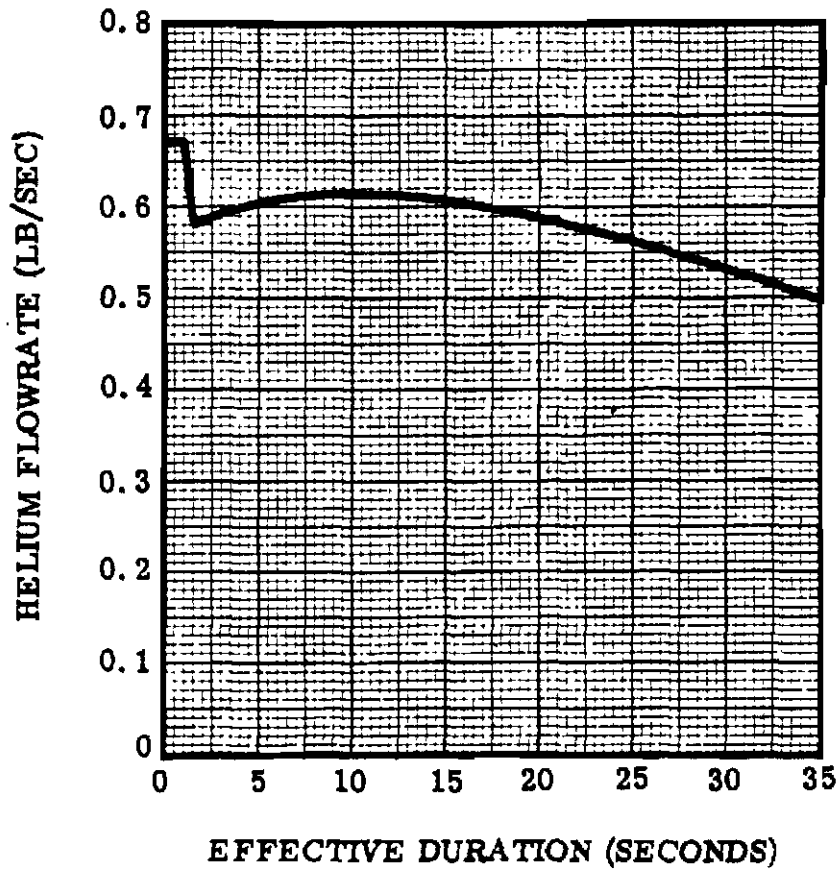

Figure 2-9. LOX Temperature Versus Flow and Accumulated Engine Test Duration Curve



F1-1-9

Figure 2-9A. Estimated Helium Inlet Temperature Transient for Heat Exchanger



F1-1-10

Figure 2-9B. Estimated Helium Flowrate Transient for Heat Exchanger

Figure 2-9C deleted.

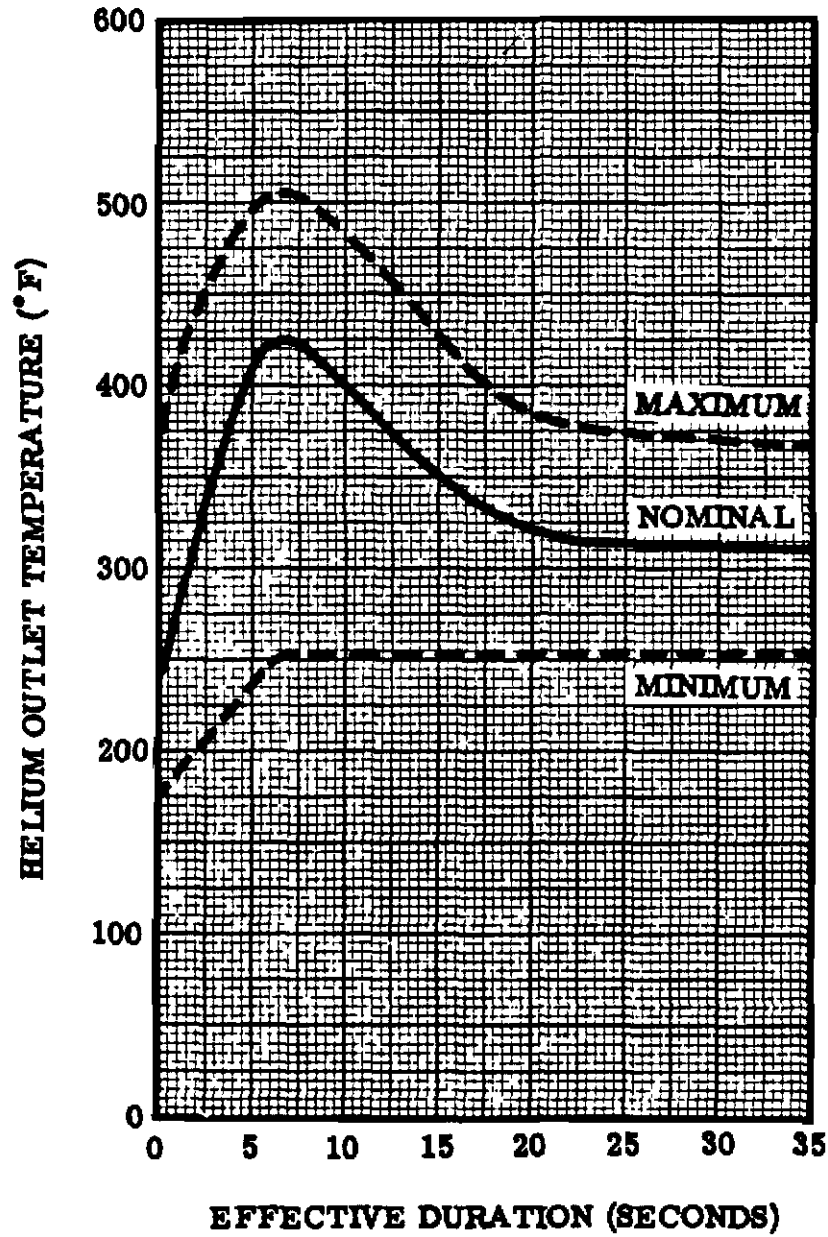

F1-1-12

Figure 2-9D. Estimated Helium Outlet Temperature Transient for Heat Exchanger

Change No. 9 - 4 November 1970

2-8C

Figure 2-9E deleted.

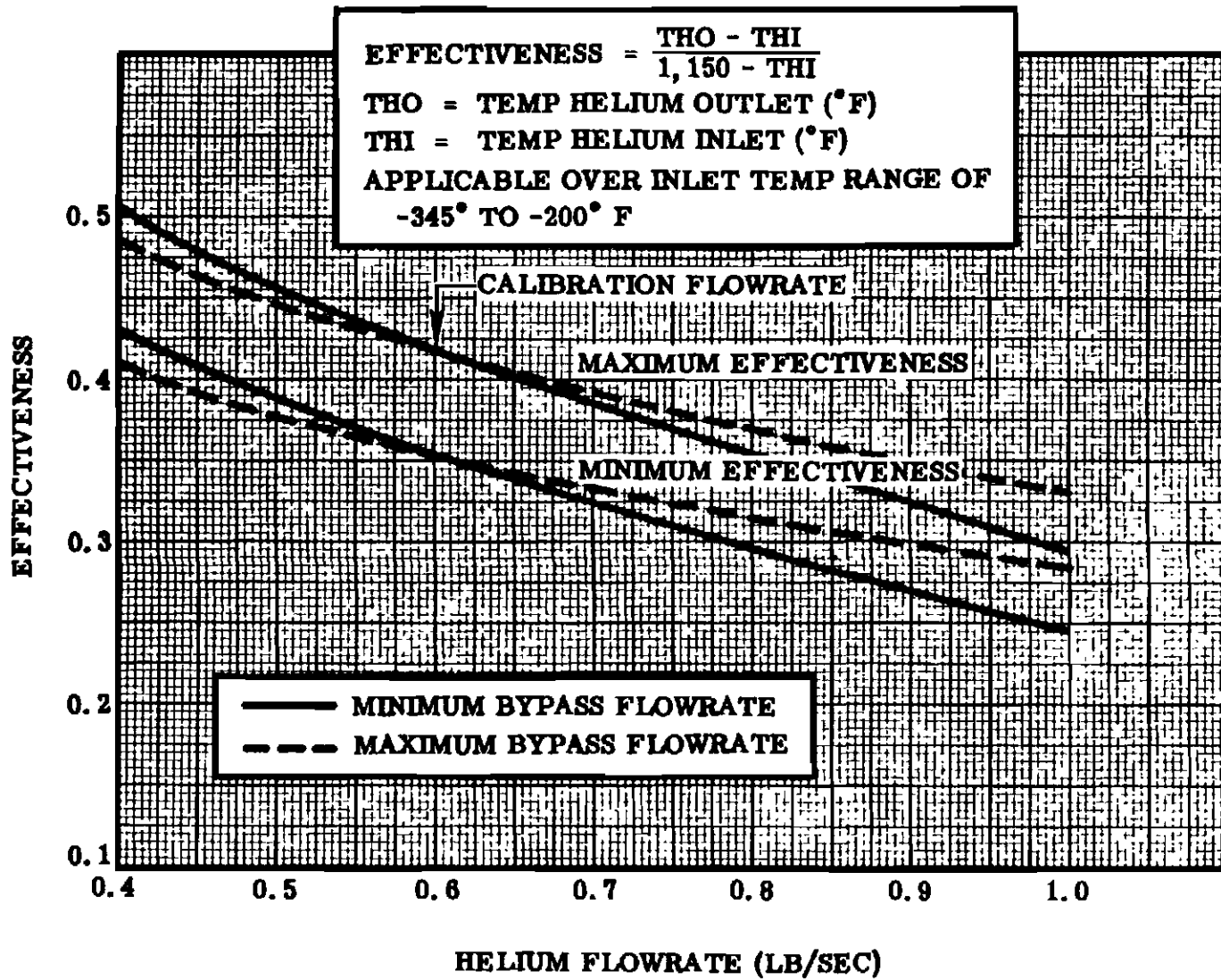

F1-1-14

Figure 2-9F. Estimated Helium Effectiveness Versus Helium Flowrate for Steady-State Operation of Heat Exchanger

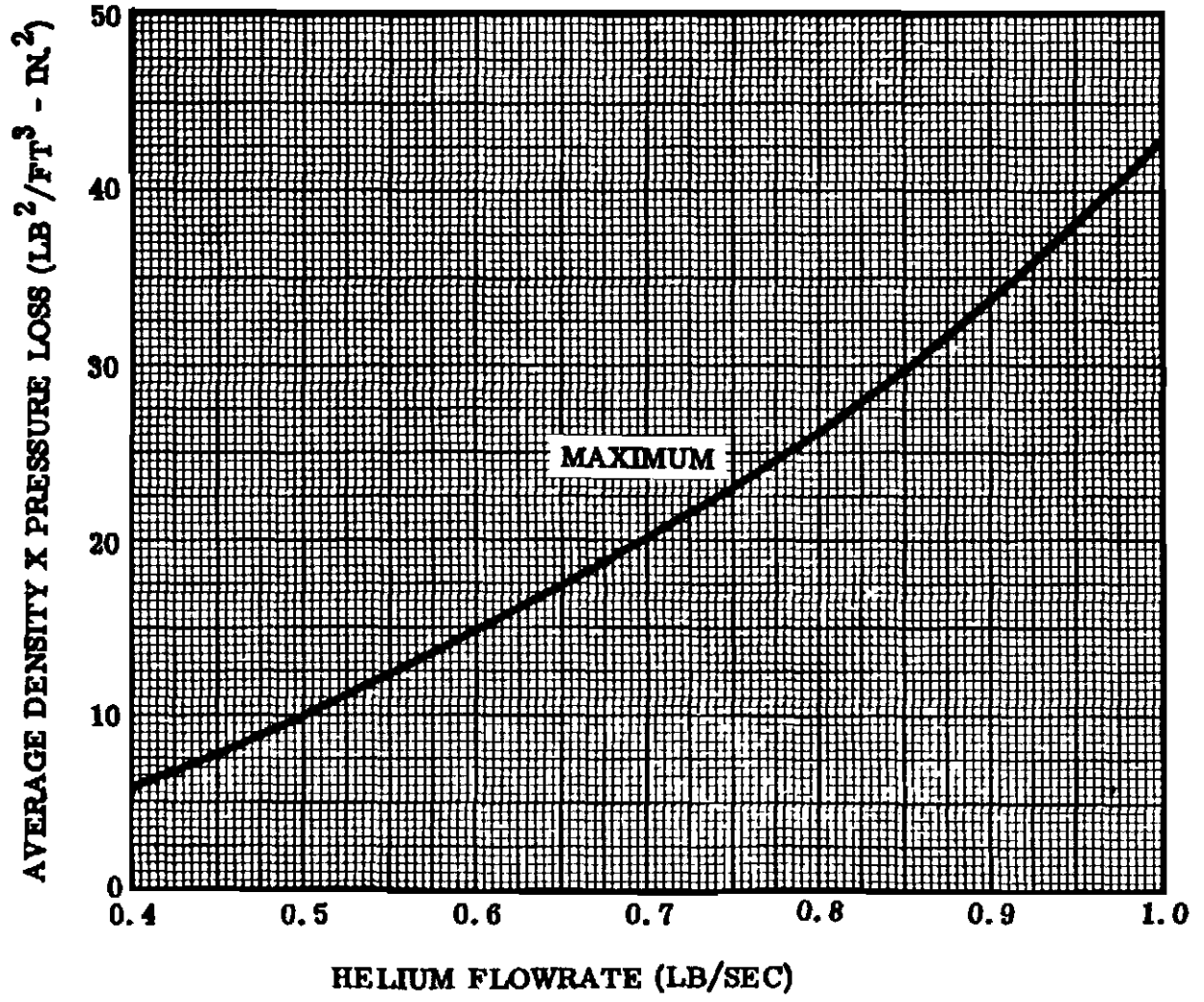

F1-1-16

Figure 2-9H. Estimated Helium Pressure Loss Versus Helium Flowrate for Steady-State Operation of Heat Exchanger

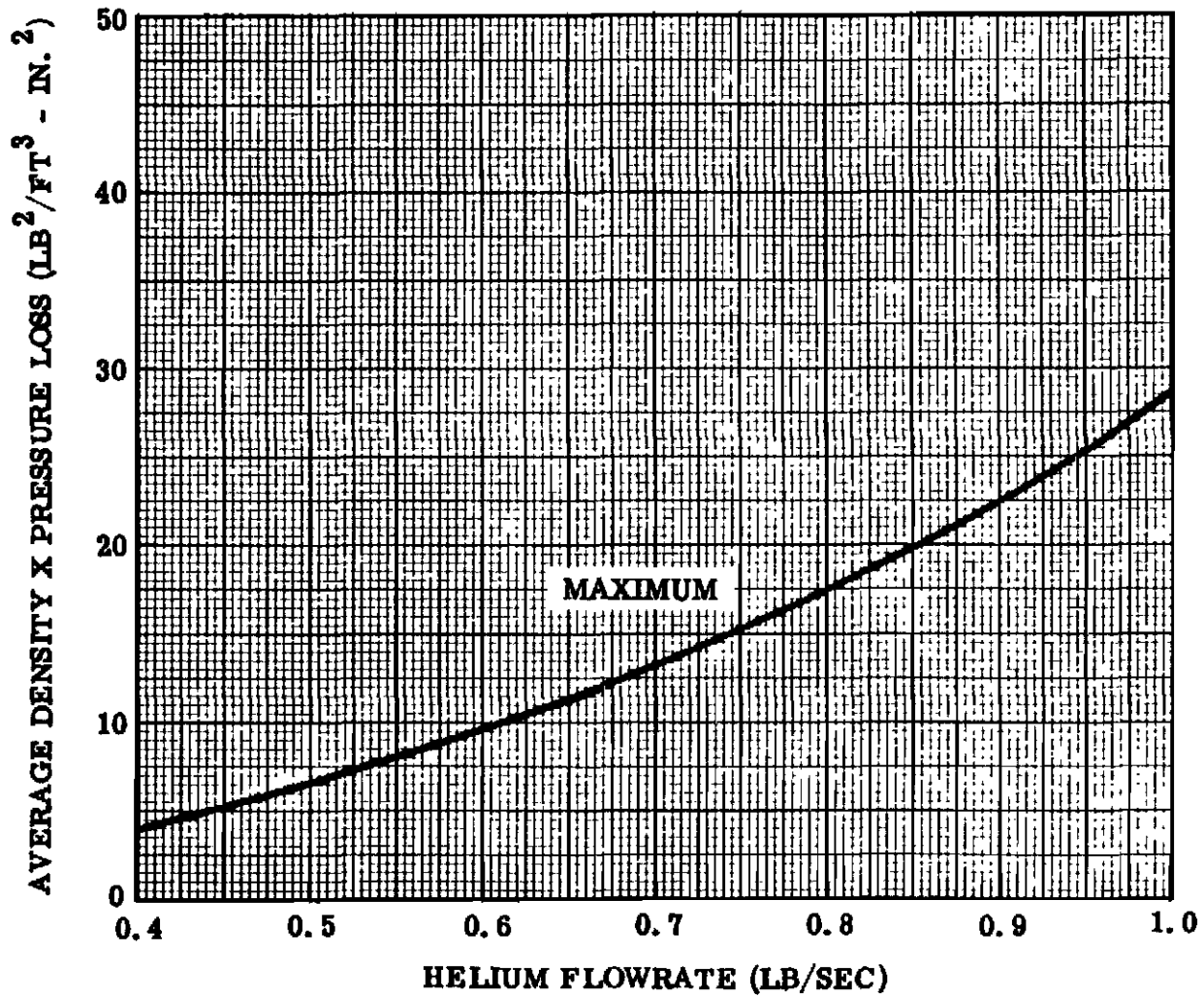

F1-1-15

Figure 2-9G. Estimated Helium Pressure Loss Versus Helium Flowrate for Steady-State Operation of Heat Exchanger (Engines F-2003 Through F-2028)

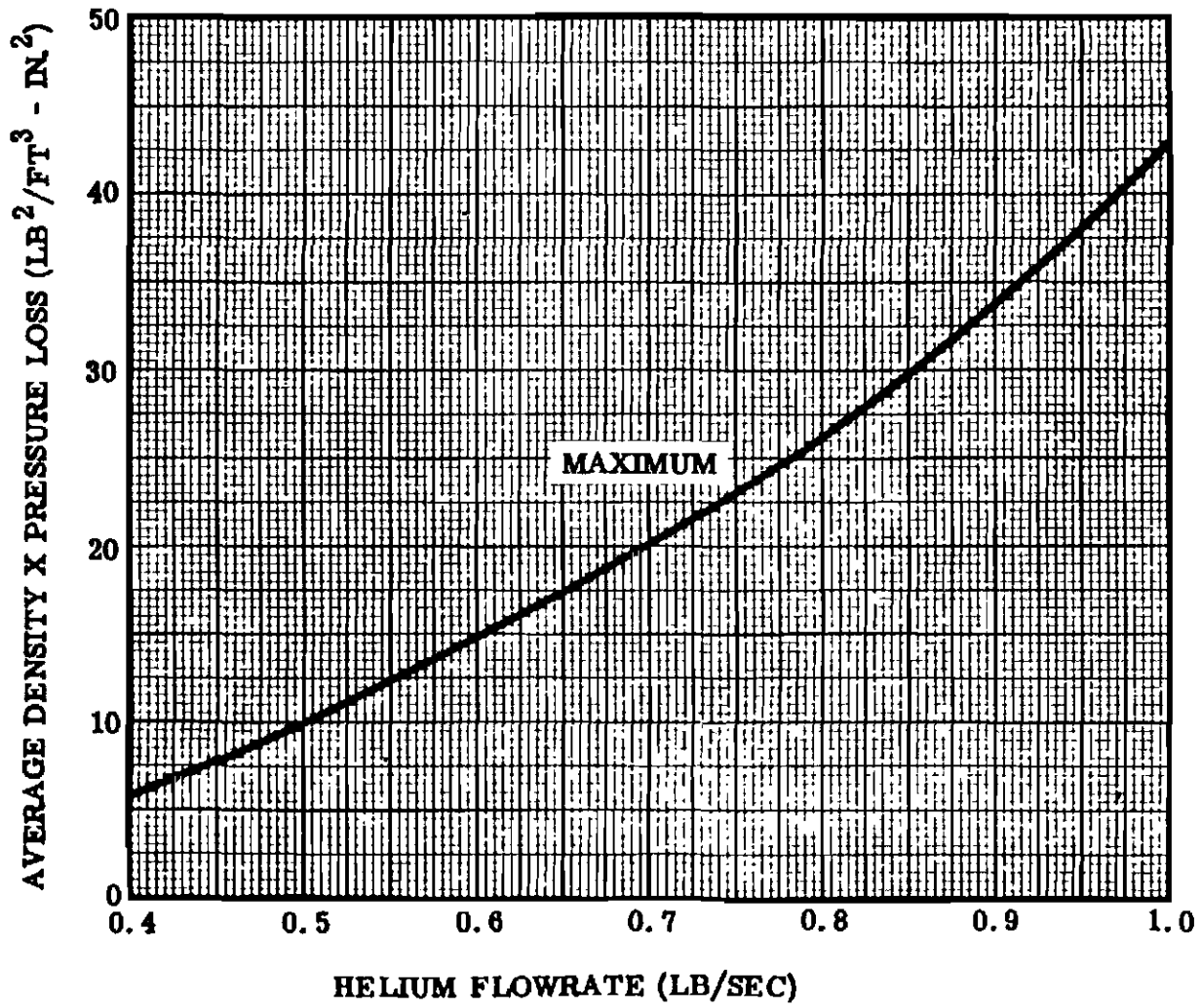

F1-1-16

Figure 2-9H. Estimated Helium Pressure Loss Versus Helium Flowrate for Steady-State Operation of Heat Exchanger (Engines F-2029 and Subsequent)

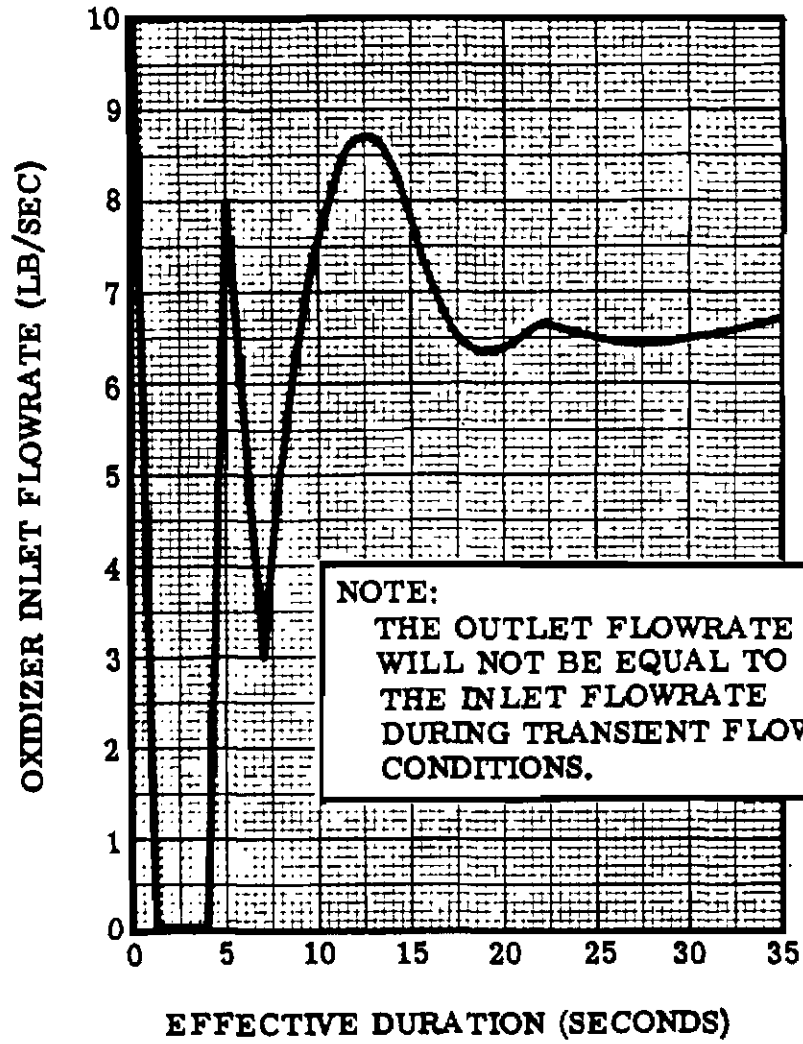

F1-1-17

Figure 2-9J. Estimated Oxidizer Flowrate Transient for Heat Exchanger

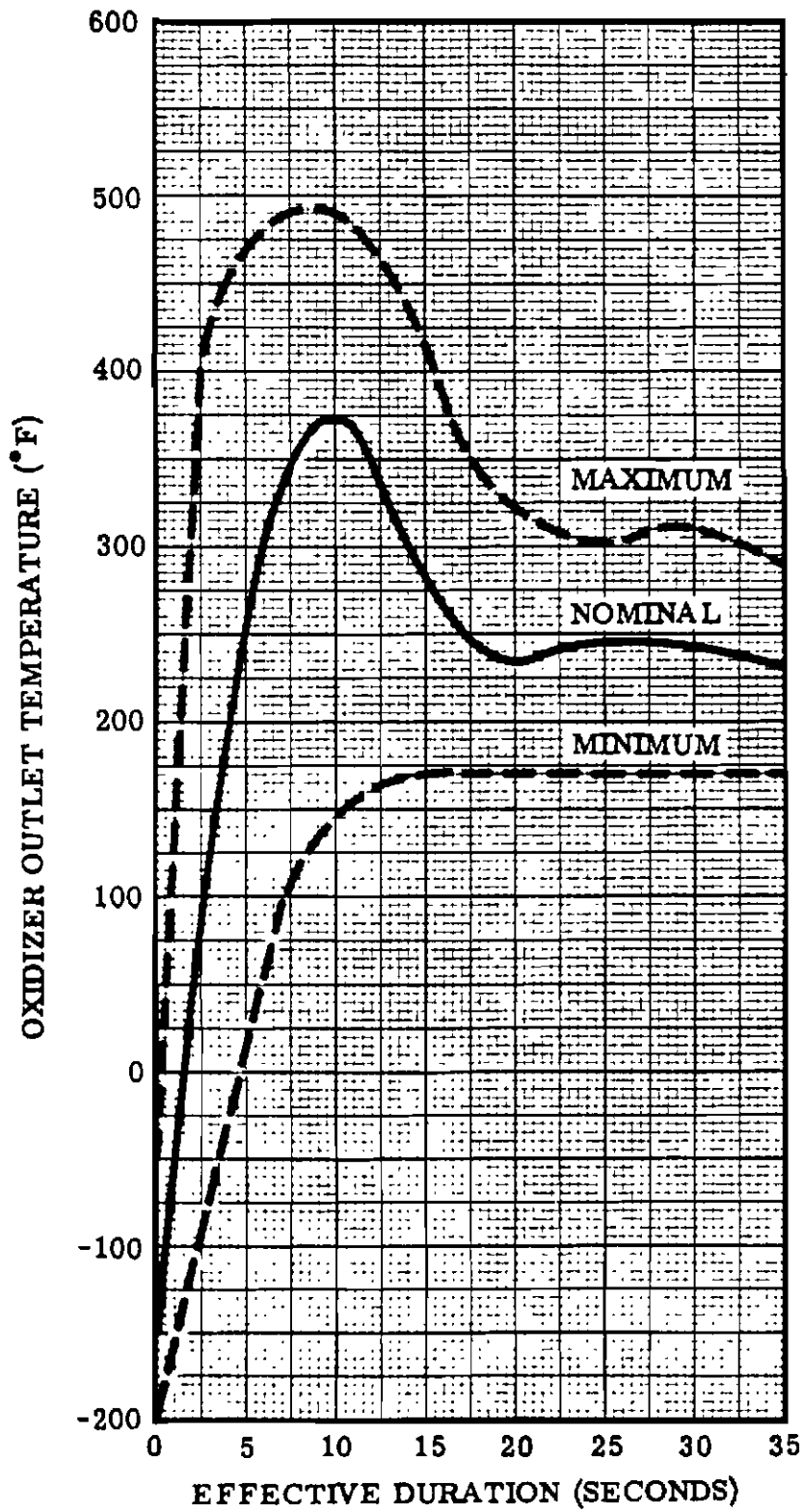

F1-1-18

Figure 2-9K. Estimated Oxidizer Outlet Temperature Transient for Heat Exchanger

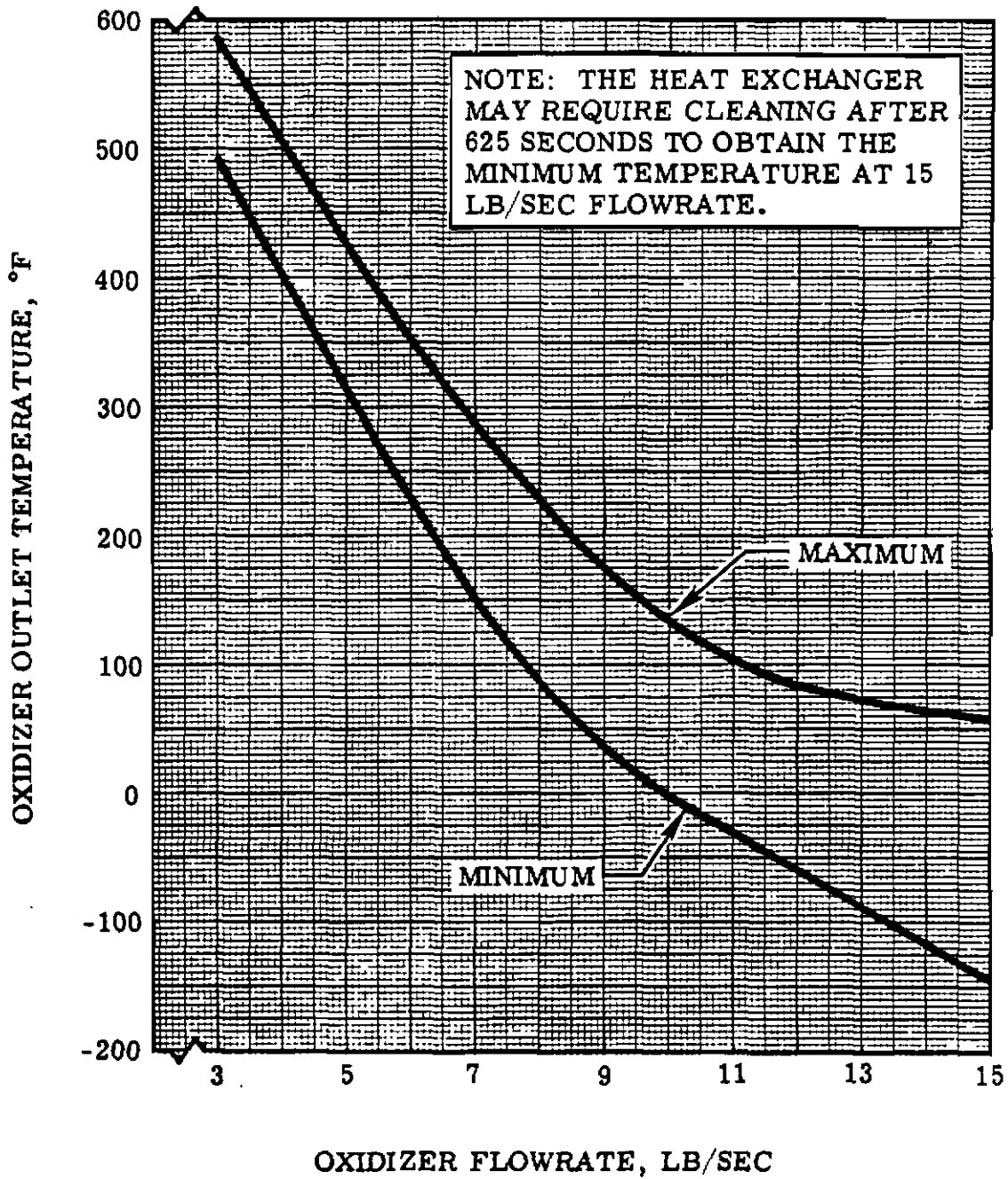

F1-1-19B

Figure 2-9L. Estimated Oxidizer Outlet Temperature Versus Oxidizer Flowrate for Steady-State Operation of Heat Exchanger

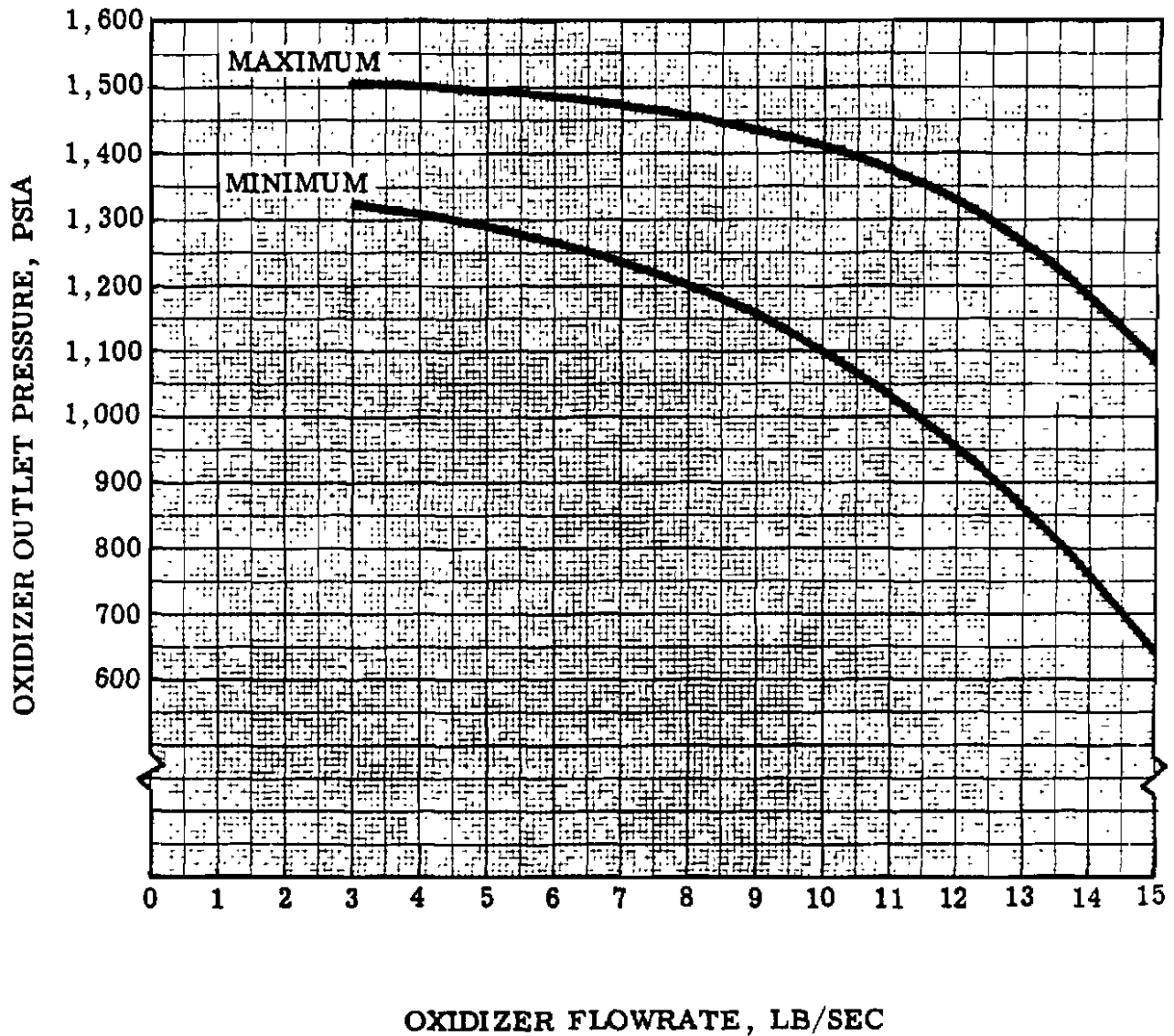

F1-1-20A

Figure 2-9M. Estimated Oxidizer Outlet Pressure Versus Oxidizer Flowrate for Steady-State Operation of Heat Exchanger

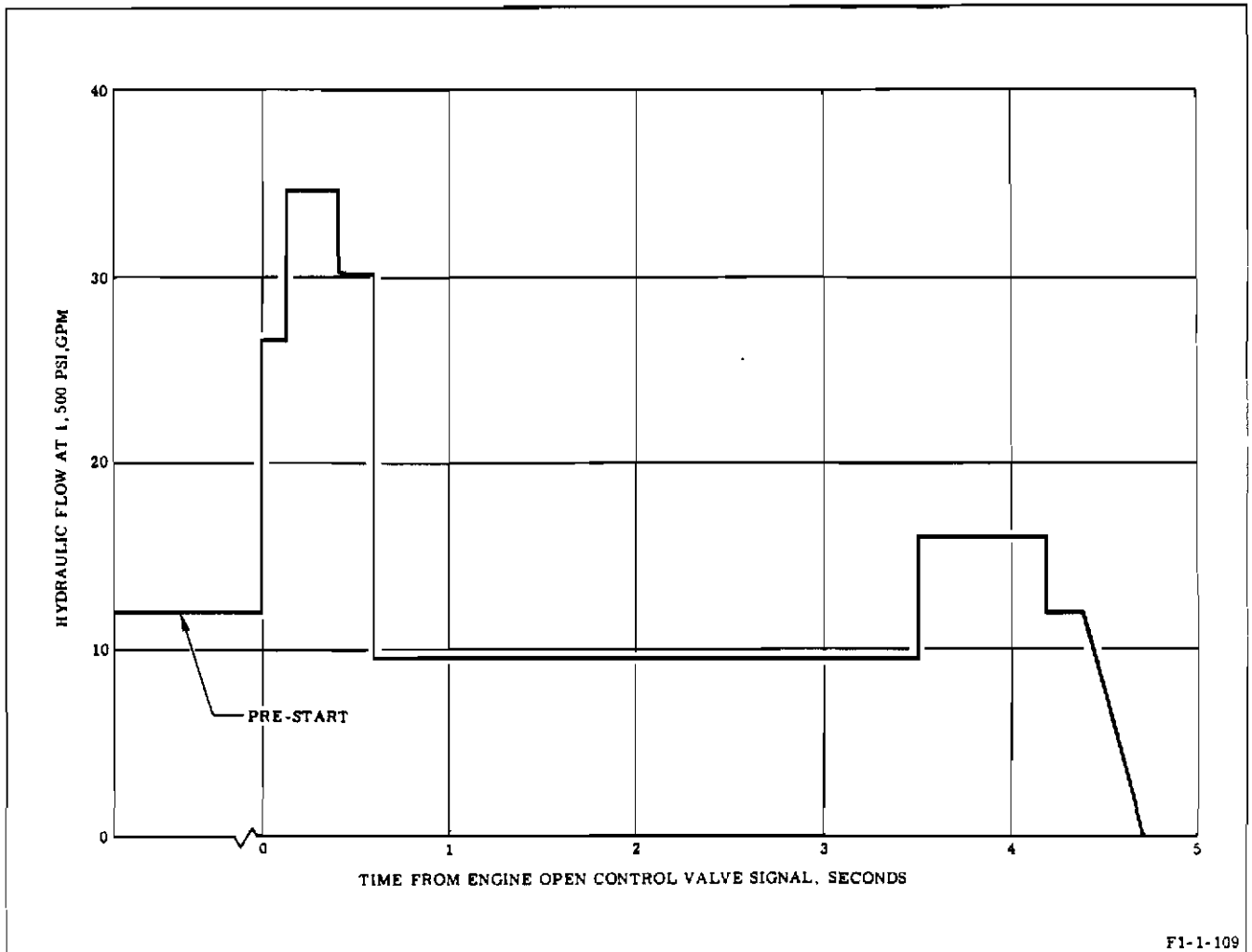

Figure 2-10. Hydraulic Flowrate at Nominal Control System Values

2-25. The engine without thermal insulation installed, when supplied with required operating fluids, electrical power, and fuel and oxidizer propellants, will not suffer detrimental effects when exposed to an ambient temperature range of 0° to 130° F for 16 hours, except as limited by the freezing point of the thrust chamber pre-fill fluid.

2-26. The engine with thermal insulation installed, when supplied with required operating fluids, electrical power, and fuel and oxidizer propellants, will not suffer detrimental effects

when exposed to an ambient temperature range of 28° to 130° F for 16 hours, except as limited by the freezing point of the thrust chamber pre-fill fluid.

2-27. GROUND HYDRAULIC FLUID SUPPLY TEMPERATURE.

2-28. Ground hydraulic fluid supplied to the engine must be within a temperature range of 60° to 130° F and a pressure range of 1,400-1,800 psig at the customer connect point whenever oxidizer propellant is in the engine.

2-29. THERMAL INSULATION COCOON ENVIRONMENTAL CONDITIONING ENVELOPE.

2-30. The recommended thermal insulation cocoon environmental conditioning external input to maintain a safe engine starting temperature within the cocoon is presented in figure 2-11. The heated purge supply should be turned on any time the ambient air temperature is 55° F or less with oxidizer propellant in the engine. GN₂ supplied to the engine interface at temperatures and pressures of figure 2-11 and the above conditions will maintain the temperature inside the cocoon, as measured on the Environmental Flight Transducer, at 10° F or above when the outside ambient air temperature is 28° F or above.

2-31. MASS PROPERTIES DATA.

2-32. Weight, center of gravity, and inertia data is presented in figures 2-12 through 2-20A to aid in determination of stage-actuator-engine system combined natural frequency and also to aid in trajectory analysis.

2-33. WEIGHT STATUS.

2-34. See figure 2-12 for the approximate weights of the engine major components and figure 2-13 for the current engine weight status.

| COMPONENT | Weight (Pounds) |
|---|-----------------|
| Gas Generator Assembly (Including combustor, injector, and ball valve) | 218 |
| Heat Exchanger | 823 |
| Thrust Chamber | |
| Oxidizer Dome | 1,573 |
| Injector | 1,171 |
| Thrust Chamber Body | 5,237 |
| Extension Nozzle | 1,621 |
| Gimbal Bearing | 426 |
| Oxidizer System | |
| Oxidizer Valve | 168 |
| No. 1 Turbopump Oxidizer Outlet Line | 96 |
| No. 2 Turbopump Oxidizer Outlet Line | 70 |
| Fuel System | |
| Fuel Valve | 90 |
| No. 1 Turbopump Fuel Outlet Line | 85 |
| No. 2 Turbopump Fuel Outlet Line | 68 |
| Adapter (Inlet to pump) | 81 |
| Turbopump (Average) | 3,150 |
| Hypergol Assembly (Including container, cartridge, mount, and ignition monitor valve) | 40 |
| Hydraulic Filter and Four-Way Solenoid Valve Manifold | 39 |
| Interface Panel (Without connectors) | 413 |

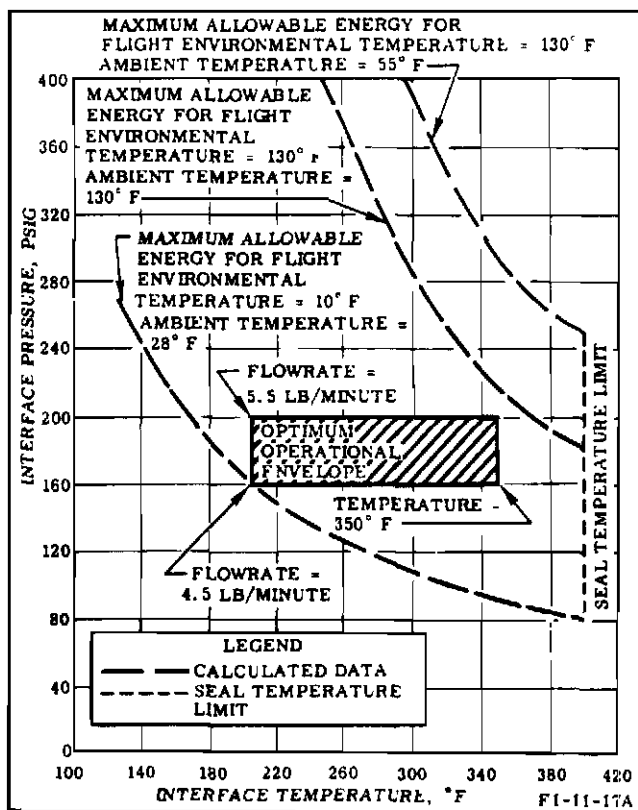

Figure 2-11. Recommended Thermal Insulation Cocoon Purge Operating Range Envelope

Figure 2-12. Major Component Weight List

| Item | DESCRIPTION | Weight (Pounds) | | | |
|-------|---|--------------------------|--------------------------|--------------------------|------------------------------------|
| | | F-2029 Thru F-2042 | F-2043 Thru F-2065 | F-2066 Thru F-2089 | F-2045-1, F-2090 and Subs |
| 1 + 2 | Rocket Engine--Wet | 20,850 | 20,746 | 20,766 | 20,833 |
| 1 + 3 | Rocket Engine--Burnout | 20,431 | 20,327 | 20,347 | 20,415 |
| 1 | Rocket Engine--Dry | 18,682 | 18,578 | 18,598 | 18,616 |
| | Thrust Chamber (Including skirt, 1,621 lb) | 8,508 | 8,508 | 8,508 | 8,511 |
| | Gimbal Bearing | 467 | 467 | 467 | 467 |
| | Turbopump | 3,152 | 3,150 | 3,151 | 3,149 |
| | Turbopump Mount (Including provisions on T/C, 286 lb) | 342 | 342 | 342 | 342 |
| | Oxidizer System | 651 | 651 | 651 | 653 |
| | Fuel System | 646 | 646 | 642 | 642 |
| | Purge System | 39 | 39 | 39 | 39 |
| | Electrical System | 83 | 83 | 85 | 85 |
| | Gimbal Supply System | 180 | 180 | 181 | 181 |
| | Gas Generator System | 336 | 336 | 336 | 336 |
| | Exhaust System (Including T/C exhaust manifold, 826 lb) | 995 | 995 | 997 | 998 |
| | Flight Instrumentation | 249 | 146 | 146 | 146 |
| | Ignition System | 52 | 52 | 52 | 52 |
| | Interface Installation | 536 | 536 | 543 | 543 |
| | Pressurization System (Including heat exchanger, 823 lb) | 1,022 | 1,019 | 1,019 | 1,029 |
| | Hydraulic Control System | 166 | 167 | 195 | 195 |
| | Thermal Insulation--Permanent | 58 | 58 | 72 ^(a) | 72 |
| | Thermal Insulation Set (TIS) | 1,200 | 1,200 | 1,186 | 1,186 |
| 2 | Rocket Engine Fluids (System Full) | 2,168 | 2,168 | 2,168 | 2,217 |
| 3 | Rocket Engine Fluids (Burnout) | 1,749 | 1,749 | 1,749 | 1,799 |

(a) Effective on engines F-2079 and subsequent.

Figure 2-13. Engine Weight Status

2-35. ENGINE COORDINATE AXES.

2-36. See figure 2-14 for engine coordinate axes.

2-37. CENTER OF GRAVITY AND INERTIA DATA.

2-38. See figures 2-18 through 2-20A for the current engine weight, center of gravity, and inertia data.

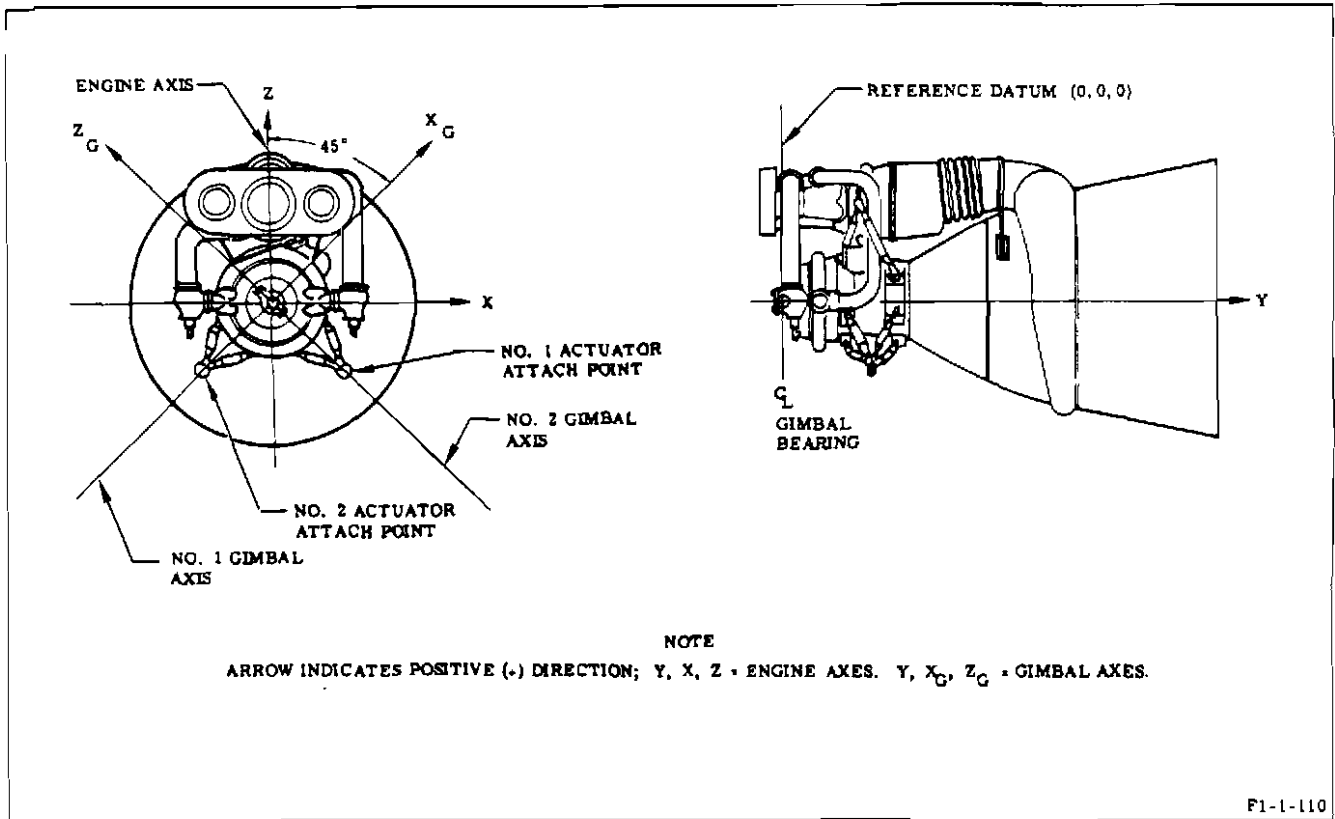

Figure 2-14. Coordinate Axis Diagram

Figures 2-15 through 2-17 deleted.

| Item | Description | Weight (Lb) | Center of Gravity (Inches) | | | Axis System Orientation | Origin of Axes (Inches) | | | Moment of Inertia (Slug Ft ²) | | |
|--------------------|---------------------|-------------|----------------------------|---------------|---------------|-------------------------|-------------------------|-------|-------|---|--------|--------|
| | | | \bar{Y} (+) | \bar{X} (+) | \bar{Z} (+) | | Y (+) | X (+) | Z (+) | I_y | I_x | I_z |
| (1) | Rocket Engine-- Dry | 18,682 | 56.2 | 11.8 | 11.9 | Gimbal | 56.2 | 11.8 | 11.9 | 6,822 | 17,497 | 17,532 |
| (2) | Rocket Engine-- Wet | 20,851 | 54.3 | 12.1 | 12.1 | Gimbal | 54.3 | 12.1 | 12.1 | 7,558 | 18,841 | 18,935 |
| (3) ^(a) | Wet Gimbaleed Mass | 20,637 | 54.9 | 12.3 | 12.2 | Gimbal | 54.9 | 12.3 | 12.2 | 7,547 | 18,687 | 18,772 |

(a) Product of Inertia (Slug Ft²): $I_{xz} = +886$, $I_{yz} = -913$, $I_{xy} = -966$

Figure 2-18. Weight, Center of Gravity, Moment of Inertia, and Product of Inertia Data (Engines F-2029 Through F-2042)

| Item | Description | Weight (Lb) | Center of Gravity (Inches) | | | Axis System Orientation | Origin of Axes (Inches) | | | Moment of Inertia (Slug Ft ²) | | |
|--------------------|------------------------|----------------|-------------------------------|------------------|------------------|----------------------------|----------------------------|----------|----------|--|----------------|----------------|
| | | | \bar{Y} (+) | \bar{X} (+) | \bar{Z} (+) | | Y (+) | X (+) | Z (+) | I _y | I _x | I _z |
| (1) | Rocket Engine-- Dry | 18,578 | 56.3 | 11.8 | 11.8 | Gimbal | 56.3 | 11.8 | 11.8 | 6,790 | 17,448 | 17,499 |
| (2) | Rocket Engine-- Wet | 20,746 | 54.4 | 12.1 | 11.9 | Gimbal | 54.4 | 12.1 | 11.9 | 7,529 | 18,795 | 18,901 |
| (3) ^(a) | Wet Gimbale Mass | 20,533 | 55.0 | 12.3 | 12.1 | Gimbal | 55.0 | 12.3 | 12.1 | 7,636 | 18,800 | 18,895 |

(a) Product of inertia (slug ft²): $I_{xz} = +880$, $I_{yz} = -893$, $I_{xy} = -961$

Figure 2-19. Weight, Center of Gravity, Moment of Inertia, and Product of Inertia Data
(Engines F-2043 Through F-2065)

| Item | Description | Weight (Lb) | Center of Gravity (Inches) | | | Axis System Orientation | Origin of Axes (Inches) | | | Moment of Inertia (Slug Ft ²) | | |
|--------------------|------------------------|----------------|-------------------------------|------------------|------------------|----------------------------|----------------------------|----------|----------|--|----------------|----------------|
| | | | \bar{Y} (+) | \bar{X} (+) | \bar{Z} (+) | | Y (+) | X (+) | Z (+) | I _y | I _x | I _z |
| (1) | Rocket Engine-- Dry | 18,598 | 56.3 | 11.6 | 11.7 | Gimbal | 56.3 | 11.6 | 11.7 | 6,809 | 17,437 | 17,470 |
| (2) | Rocket Engine-- Wet | 20,766 | 54.4 | 12.0 | 11.9 | Gimbal | 54.4 | 12.0 | 11.9 | 7,548 | 18,779 | 18,866 |
| (3) ^(a) | Wet Gimbale Mass | 20,553 | 55.0 | 12.1 | 12.0 | Gimbal | 55.0 | 12.1 | 12.0 | 7,534 | 18,625 | 18,712 |

(a) Product of inertia (slug ft²): $I_{xz} = +894$, $I_{yz} = -956$, $I_{xy} = -1,033$

Figure 2-20. Weight, Center of Gravity, Moment of Inertia, and Product of Inertia Data
(Engines F-2066 Through F-2089)

| Item | Description | Weight (Lb) | Center of Gravity (Inches) | | | Axis System Orientation | Origin of Axes (Inches) | | | Moment of Inertia (Slug Ft ²) | | |
|--------------------|------------------------|----------------|-------------------------------|------------------|------------------|----------------------------|----------------------------|----------|----------|--|----------------|----------------|
| | | | \bar{Y} (+) | \bar{X} (+) | \bar{Z} (+) | | Y (+) | X (+) | Z (+) | I _y | I _x | I _z |
| (1) | Rocket Engine-- Dry | 18,616 | 56.4 | 11.6 | 11.7 | Gimbal | 56.4 | 11.6 | 11.7 | 6,830 | 17,537 | 17,577 |
| (2) | Rocket Engine-- Wet | 20,833 | 54.5 | 12.0 | 11.9 | Gimbal | 54.4 | 12.0 | 11.9 | 7,583 | 18,895 | 18,984 |
| (3) ^(a) | Wet Gimbaleed Mass | 20,620 | 55.1 | 12.1 | 12.0 | Gimbal | 55.1 | 12.1 | 12.0 | 7,569 | 18,741 | 18,830 |

(a) Product of inertia (slug ft²): I_{xz} = +899, I_{yz} = -967, I_{xy} = -1,046

Figure 2-20A. Weight, Center of Gravity, Moment of Inertia, and Product of Inertia Data
 (Engines F-2045-1 and F-2090 Through F-2098)

2-39. INTERFACE CONNECTIONS.

2-40. Interface connections shown contain only physical descriptions of the interface connect points, engine envelope, and engine instrumentation tap locations. For detail design criteria, refer to F-1 Engine Interface Document, R-6749.

2-41. INTERFACE CONNECT POINTS.

2-42. See figure 2-21 for location on engine of stage interface connect points and for engine servicing connect points.

2-43. ENVELOPE DIMENSIONS.

2-44. See figure 2-22 for engine envelope dimensions.

2-45. ELECTRICAL INTERFACE.

2-46. See figure 2-23 for the connector numbers, connector types, pin functions, and other characteristics concerned with electrical

interface requirements. An explanation of the terminology used is as follows:

- Pin The pin letter assigned is for both halves of the interface and was derived from the letters on the connector. Signals have been referenced to specific pins.
- Functional Description The purpose and need for the signal in relation to the circuit involved.
- Origin The source of the signal.
- Termination The terminating or receiving point of the signal.

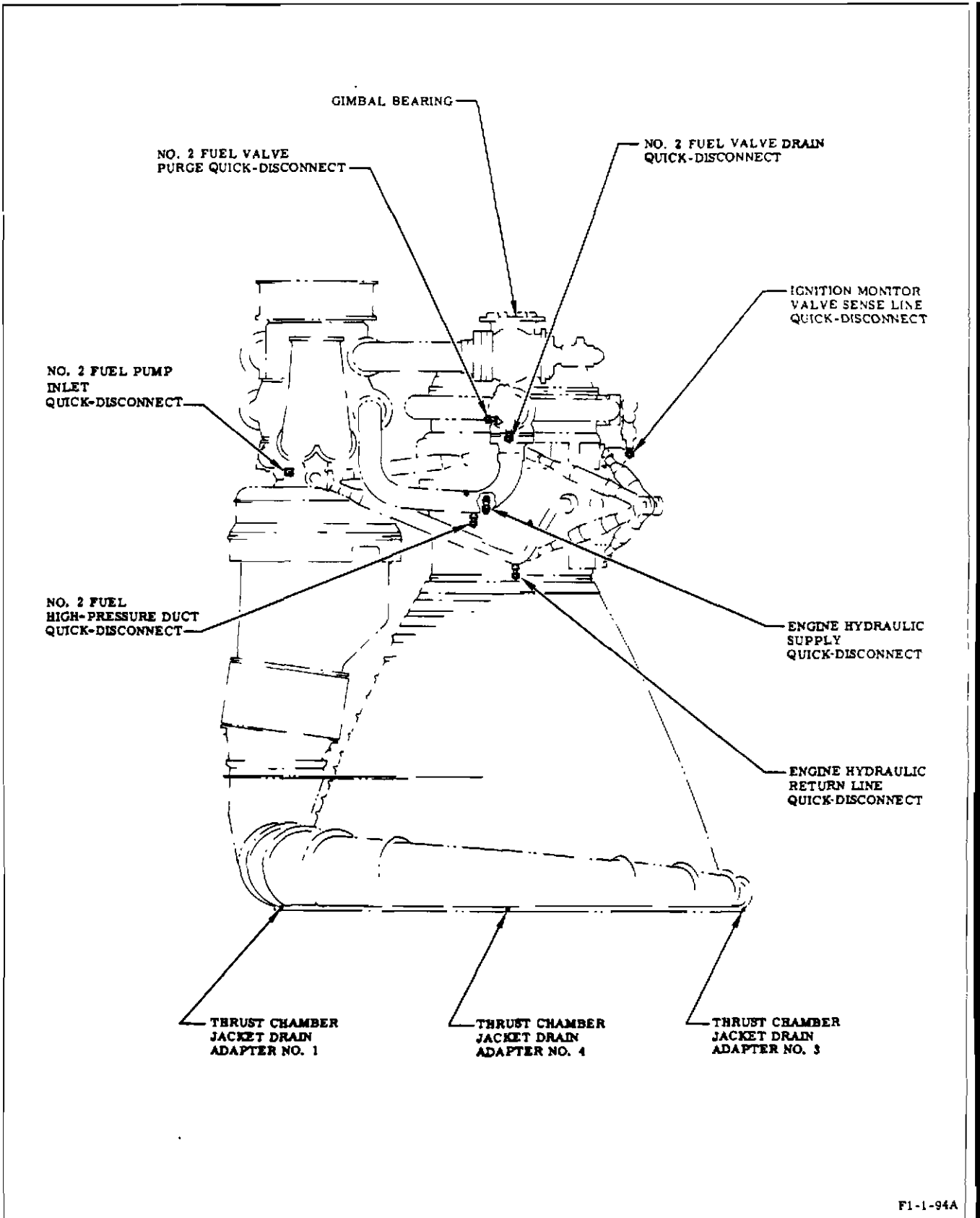
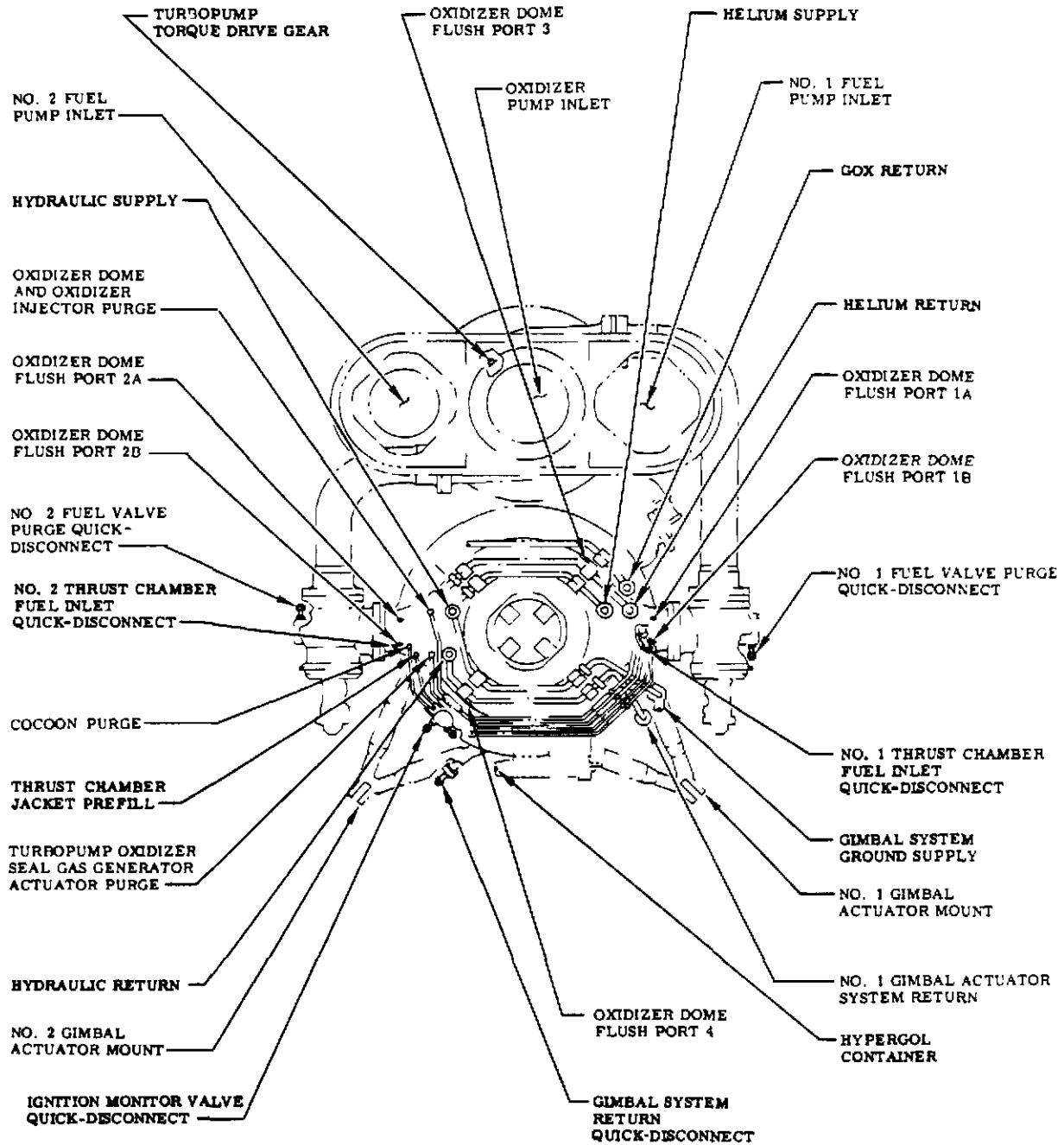
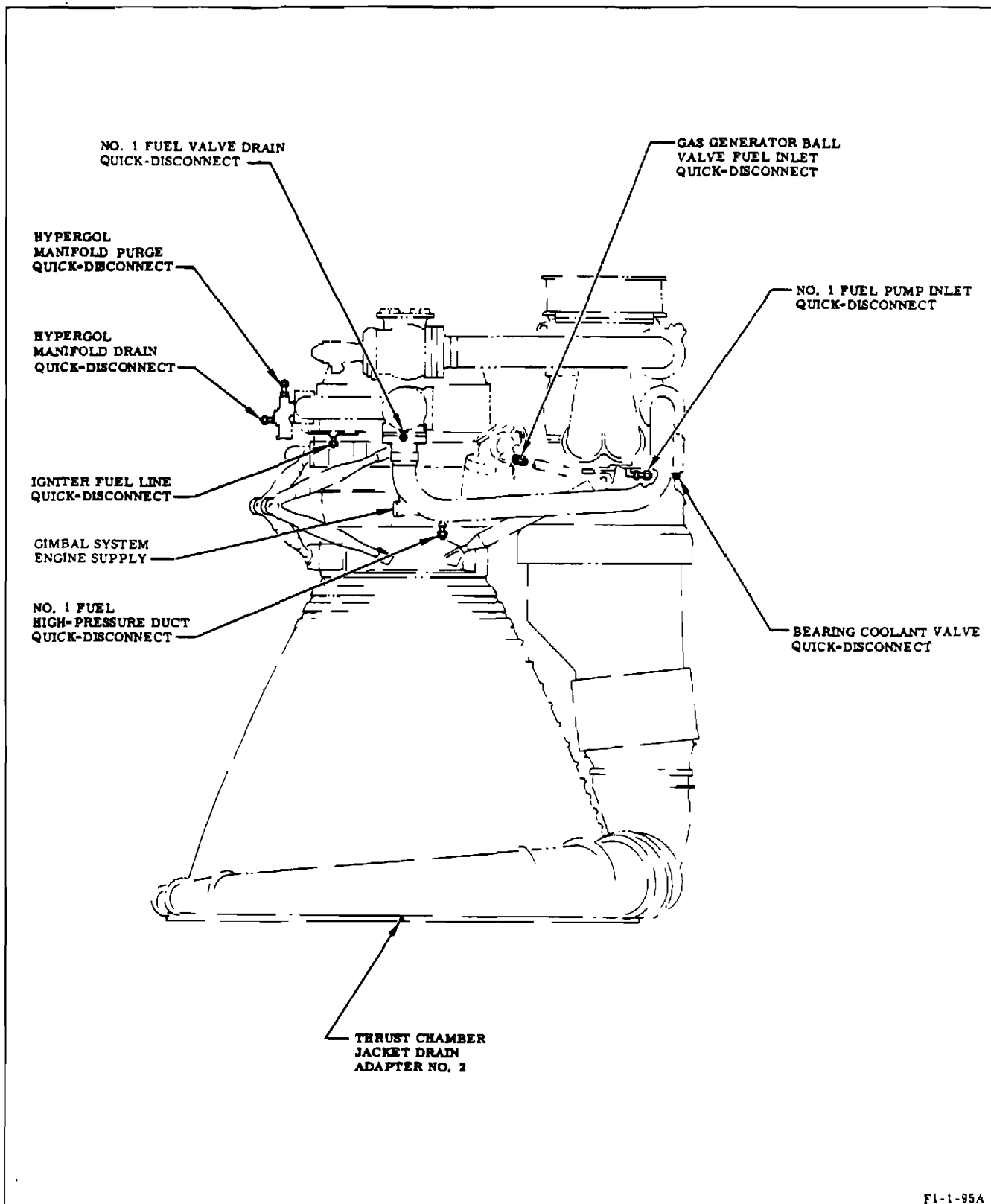

Figure 2-21. Operating and Servicing Interface Connections (Sheet 1 of 3)



F1-1-32B

Figure 2-21. Operating and Servicing Interface Connections (Sheet 2 of 3)



F1-1-95A

Figure 2-21. Operating and Servicing Interface Connections (Sheet 3 of 3)

Pages 2-19 through 2-22 deleted.

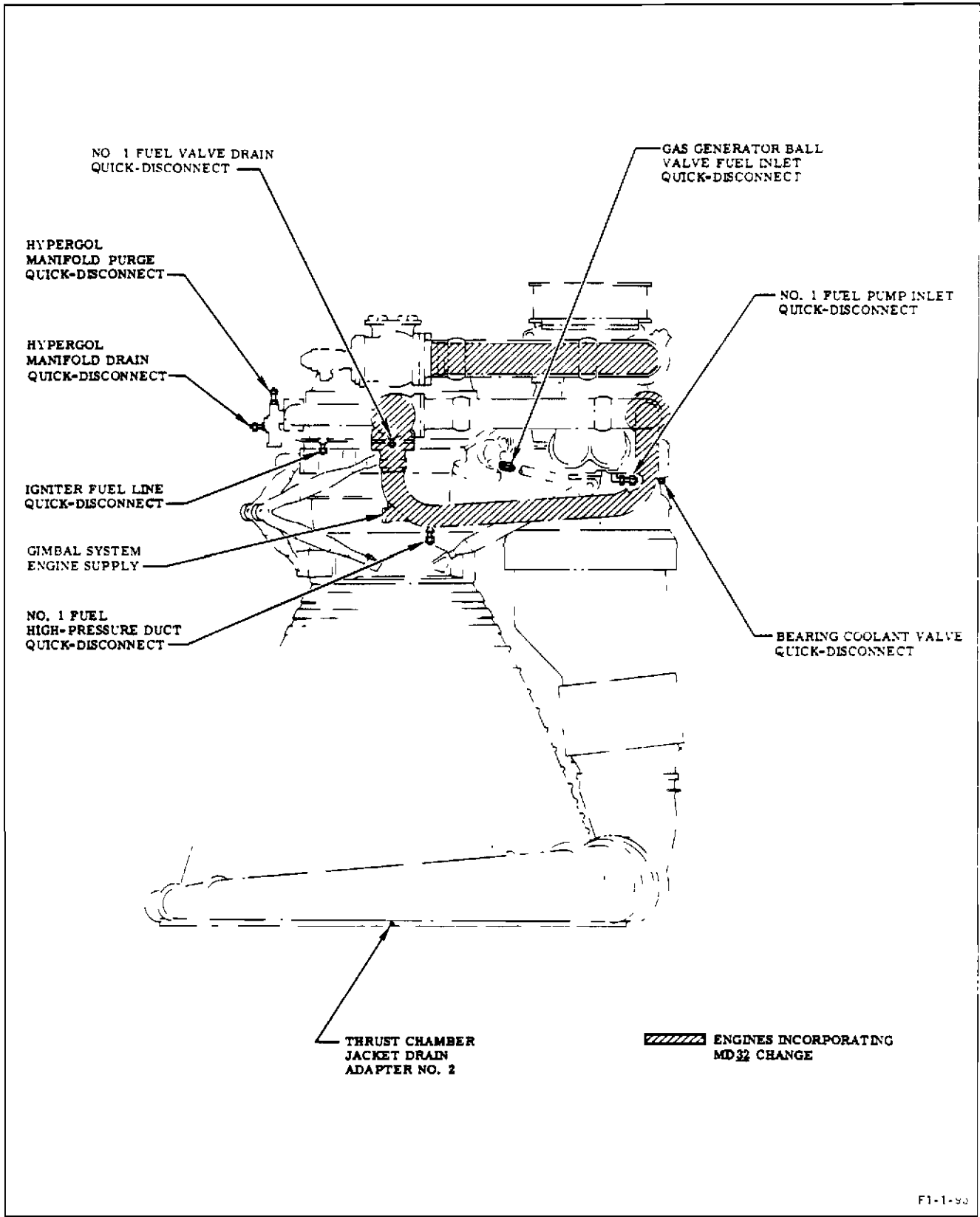

Figure 2-21. Interface Operating and Servicing Connections (Sheet 3 of 3)

All data on pages 2-21 and 2-22 deleted.

| No | Description | X | Y | Z | End Configuration | THK (Bolt Engage) | NOM Line Size | Flange Configuration | | | | No of Bolts | Monitor Hole ϕ to BC | Comments |
|----|---|--|--------------------------------------|--|----------------------------|-------------------|---------------|----------------------|--------|--------|---------|-------------|---------------------------|---------------------------------|
| | | | | | | | | OD | ID | BC | Hole | | | |
| 13 | No 1 and No 2 Turbopump Fuel Inlets (Interface) | +25.86 \pm 0.36 -25.86 \pm 0.36 | +5.18 \pm 0.18 | +50.00 \pm 0.14 | Fixed Flange | -- | -- | 14.75 | 11.76 | 13.250 | 5/16-24 | 40 | -- | 2 joints 5/16-24 (Keenserts) |
| | | (+25.86 \pm 0.61 -25.86 \pm 0.61) | +5.18 \pm 0.18 | +50.00 \pm 0.39 (a) | | | | | | | | | | |
| 14 | Turbopump LOX Inlet (Interface) | 00.00 \pm 0.16 (00.00 \pm 0.41) | -0.81 \pm 0.15 -0.81 \pm 0.15 | +50.00 \pm 0.15 (+50.00 \pm 0.40) (a) | Tapped Face (Monitor Port) | -- | -- | -- | 16.120 | 18.500 | 7/16-20 | 38 | 0.550 | 7/16-20 (Keenserts) |
| 15 | Gimbal Actuator Engine Mount | +35.36 \pm 0.09 -35.36 \pm 0.09 | +48.90 \pm 0.13 | -35.36 \pm 0.09 | --- | -- | -- | -- | -- | -- | -- | -- | -- | 2 joints |
| | | (+35.36 \pm 0.34 -35.36 \pm 0.34) | +48.90 \pm 0.13 | -35.36 \pm 0.34 (a) | | | | | | | | | | |
| | Gimbal Actuator Engine Mount (c) | +35.36 \pm 0.14 -35.36 \pm 0.14 | +48.90 \pm 0.20 | -35.36 \pm 0.14 | --- | -- | -- | -- | -- | -- | -- | -- | -- | |
| | | (+35.36 \pm 0.39 -35.36 \pm 0.39) | +48.90 \pm 0.20 | -35.36 \pm 0.39 (a) | | | | | | | | | | |
| 16 | J18 Electrical Control | -35.30 \pm 0.08 (-35.30 \pm 0.33) | -9.12 \pm 0.12 -9.12 \pm 0.12 | +57.31 \pm 0.08 (+57.31 \pm 0.31) (a) | 36-10P | -- | -- | -- | -- | -- | -- | -- | -- | |
| 17 | J20 Electrical Control | -33.18 \pm 0.08 (-33.18 \pm 0.33) | -9.12 \pm 0.12 -9.12 \pm 0.12 | +58.44 \pm 0.08 (+58.44 \pm 0.31) (a) | 28-12P | -- | -- | -- | -- | -- | -- | -- | -- | |
| 18 | J143 Auxiliary Flight Instrumentation | -30.80 \pm 0.08 (-30.80 \pm 0.33) | -9.12 \pm 0.12 -9.12 \pm 0.12 | +61.31 \pm 0.08 (+61.31 \pm 0.31) (a) | 24-28P | -- | -- | -- | -- | -- | -- | -- | -- | |
| 19 | J140 Auxiliary Flight Instrumentation | -17.62 \pm 0.08 (-17.62 \pm 0.33) | -9.12 \pm 0.12 -9.12 \pm 0.12 | +62.50 \pm 0.08 (+62.50 \pm 0.31) (a) | 16-8P | -- | -- | -- | -- | -- | -- | -- | -- | |
| 20 | J141 Auxiliary Flight Instrumentation | -16.24 \pm 0.08 (-16.24 \pm 0.33) | -9.12 \pm 0.12 -9.12 \pm 0.12 | +58.50 \pm 0.08 (+58.50 \pm 0.31) (a) | 36-7P | -- | -- | -- | -- | -- | -- | -- | -- | |
| 21 | J800 Electrical Control | -15.86 \pm 0.08 (-15.86 \pm 0.33) | -9.12 \pm 0.12 -9.12 \pm 0.12 | +37.50 \pm 0.08 (+37.50 \pm 0.31) (a) | 18-1P | -- | -- | -- | -- | -- | -- | -- | -- | |
| | --- | --- | --- | --- | --- | -- | -- | -- | -- | -- | -- | -- | -- | |
| 23 | J104 Auxiliary Flight Instrumentation | -8.88 \pm 0.07 | -9.12 \pm 0.12 | +37.81 \pm 0.08 | 20-27P | -- | -- | -- | -- | -- | -- | -- | -- | |

- (a) This dimension includes 0.25 inch gimbal bearing lateral adjustment but does not include the adjustment for thrust chamber-to-engine centerline adjustment.
(c) Engines F-2029 and subsequent.

Figure 2-21 Interface Layout Dimensions (Sheet 5 of 6)

| No | Description | X | Y | Z | End Configuration | THK (Bolt Engage) | NOM Line Size | Flange Configuration | | | | No. of Bolts | Monitor Hole ϕ to BC | Comments |
|----|--|----------------------------------|--------------------------------|------------------------------------|-------------------|-------------------|---------------|----------------------|----|----|------|--------------|---------------------------|----------|
| | | | | | | | | OD | ID | BC | Hole | | | |
| 24 | J106 Primary Flight Instrumentation | +8.12 ±0.06 (+8.12 ±0.31) | -9.12 ±0.12 -9.12 ±0.12 | +62.19 ±0.06 (+69.19 ±0.31) (a) | 20-28P | -- | -- | -- | -- | -- | -- | -- | -- | -- |
| | J106 Primary Flight Instrumentation ^(d) | 21.12 ±0.02 (21.12 ±0.27) | -9.12 ±0.12 -9.12 ±0.12 | +61.62 ±0.01 (+61.62 ±0.26) (a) | --- | -- | -- | -- | -- | -- | -- | -- | -- | -- |
| 25 | J100 Primary Flight Instrumentation | +8.12 ±0.06 (+8.12 ±0.31) | -9.12 ±0.12 -9.12 ±0.12 | +37.81 ±0.06 (+37.81 ±0.31) (a) | 20-16P | -- | -- | -- | -- | -- | -- | -- | -- | -- |
| 26 | J102 Primary Flight Instrumentation | +11.12 ±0.06 (+11.12 ±0.31) | -9.12 ±0.12 -9.12 ±0.12 | +40.88 ±0.06 (+40.88 ±0.31) (a) | 22-14P | -- | -- | -- | -- | -- | -- | -- | -- | -- |
| 27 | J103 Primary Flight Instrumentation | +11.12 ±0.06 (+11.12 ±0.31) | -9.12 ±0.12 -9.12 ±0.12 | +38.13 ±0.06 (+38.13 ±0.31) (a) | 22-14S | -- | -- | -- | -- | -- | -- | -- | -- | -- |
| 28 | J101 Primary Flight Instrumentation | +15.74 ±0.08 (+15.74 ±0.33) | -9.12 ±0.12 -9.12 ±0.12 | +37.75 ±0.06 (+37.75 ±0.31) (a) | 28-21P | -- | -- | -- | -- | -- | -- | -- | -- | -- |
| 29 | J19 Electrical Control | +16.86 ±0.08 (+16.86 ±0.33) | -9.12 ±0.12 -9.12 ±0.12 | +40.88 ±0.06 (+40.88 ±0.31) (a) | 20-33P | -- | -- | -- | -- | -- | -- | -- | -- | -- |
| 30 | J470 Electrical Control | +21.24 ±0.08 (+21.24 ±0.33) | -9.12 ±0.12 -9.12 ±0.12 | +37.75 ±0.06 (+37.75 ±0.31) (a) | 28-12P | -- | -- | -- | -- | -- | -- | -- | -- | -- |
| | --- | --- | --- | --- | --- | -- | -- | -- | -- | -- | -- | -- | -- | -- |
| 32 | Engine Handling Pin | --- | +42.00 ±0.08 (+42.00 ±0.08) | +50.00 ±0.03 (+50.00 ±0.28) (a) | --- | -- | -- | -- | -- | -- | -- | -- | -- | -- |
| 33 | Actuator Holding Device | --- | +16.43 ±0.05 | --- | --- | -- | -- | -- | -- | -- | -- | -- | -- | -- |
| | --- | --- | --- | --- | --- | -- | -- | -- | -- | -- | -- | -- | -- | -- |
| 35 | Calps Switch Supply | -33.30 ±0.08 (-33.00 ±0.33) | -3.83 ±0.10 -3.83 ±0.10 | +40.70 ±0.06 (+40.70 ±0.31) (a) | MC-227C04 | -- | -- | -- | -- | -- | -- | -- | -- | -- |
| 36 | J142 Electrical Control | -21.025 ±0.08 (-21.025 ±0.33) | -9.12 ±0.12 -9.12 ±0.12 | +62.50 ±0.06 (+62.50 ±0.31) (a) | 145-2P | -- | -- | -- | -- | -- | -- | -- | -- | -- |
| 37 | J174 Electrical Control | +18.49 ±0.08 (+18.49 ±0.33) | -9.12 ±0.12 -9.12 ±0.12 | +37.75 ±0.06 (+37.75 ±0.31) (a) | 145-5P | -- | -- | -- | -- | -- | -- | -- | -- | -- |

(a) This dimension includes 0.25-inch gimbal bearing lateral adjustment but does not include the adjustment for thrust chamber-to-engine centerline adjustment.

(d) Engines incorporating MD87 change

Figure 2-21. Interface Layout Dimensions (Sheet 6 of 8)

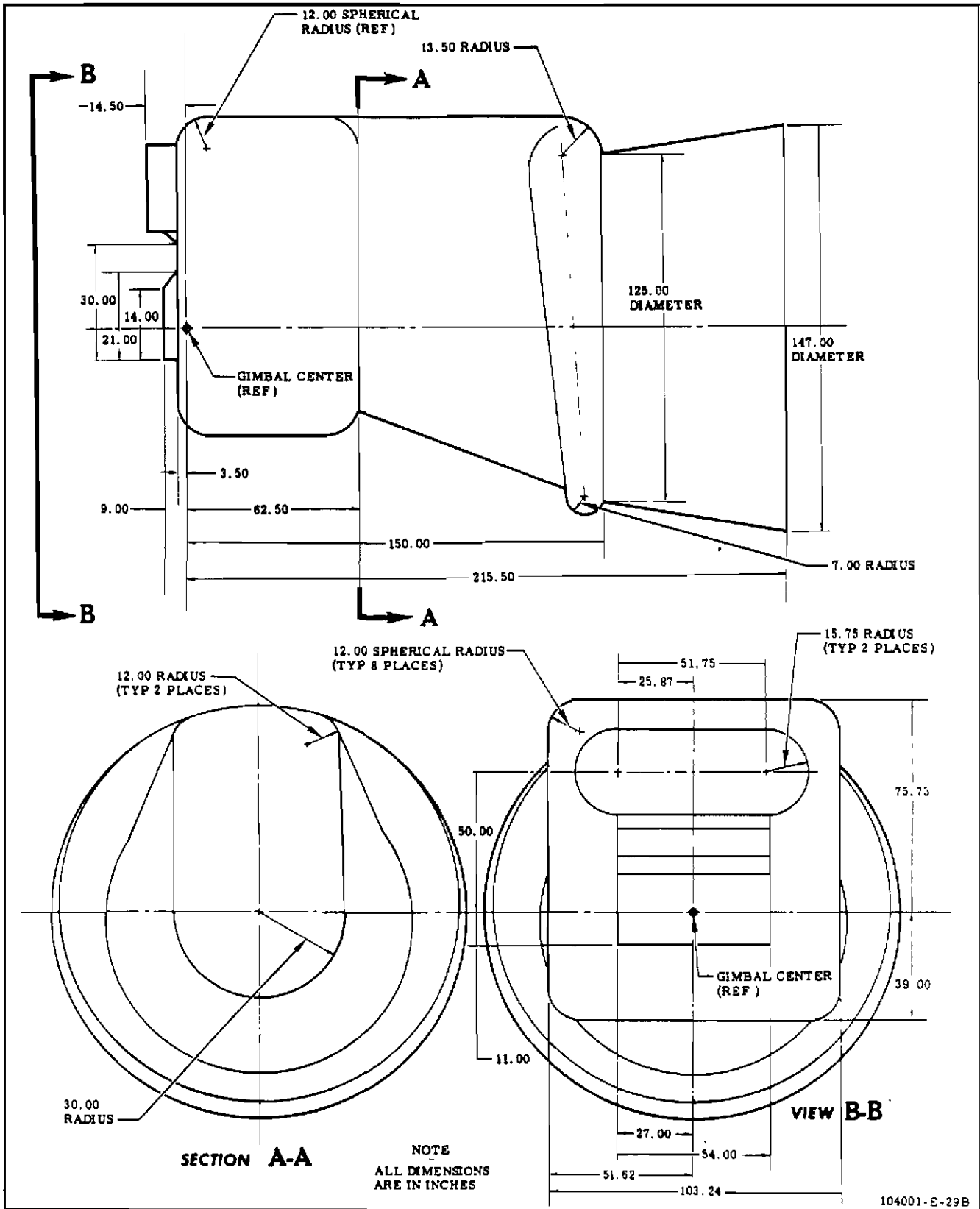

Figure 2-22. Engine Envelope Dimensions

| Pin | Functional Description | Signal | | Pin | Functional Description | Signal | |
|---|--|--------|-------------|----------|--|--------|--------------|
| | | Origin | Termination | | | Origin | Termination |
| <p>CONNECTOR J-18: Connector equivalent to an MS3101R36-10P with 48 contacts, size AWG #16</p> <p style="text-align: center;">CAUTION</p> <p>Pins <u>k</u> and <u>m</u> should be jumpered in customer connector P18 to make it electrically impossible to operate engine control valve opening solenoid without engine control valve closing solenoid connector being secured.</p> | | | | <u>h</u> | Vehicle Power Supply-- Provides vehicle power to GSE (input) | Stage | GSE |
| <u>A</u> thru <u>Y</u> | Spares | | | <u>i</u> | Engine Control Valve--Negative return for opening and closing solenoid | Engine | Stage or GSE |
| <u>Z</u> | Turbopump Thermostat Control Package--Signal indicating normal heater temperature (output) | Engine | GSE | <u>k</u> | Engine Control Valve--Negative return for opening solenoid through closing solenoid to make sure both connectors are secured | Engine | GSE |
| <u>a</u> | Turbopump Thermostat Control Package-- Loss of signal indicates above normal heater temperature (output) | Engine | GSE | <u>m</u> | Engine Control Valve--Negative return for opening solenoid through closing solenoid to make sure both connectors are secured | Engine | GSE |
| <u>b</u> | Turbopump Thermostat Control Package--Heater cycle signal (output) | Engine | GSE | <u>n</u> | Engine Control Valve--Opening solenoid energizing signal (input) | GSE | Engine |
| <u>c</u> thru <u>e</u> | Spares | | | <u>p</u> | Checkout Valve-- 28 vdc signal to drive checkout valve motor to engine return position (input) | GSE | Engine |
| <u>f</u> | Turbopump Thermostat Control Package--28 vdc power to thermostat control package (input) | GSE | Engine | <u>q</u> | Checkout Valve-- 28 vdc signal to drive checkout valve motor to ground return position (input) | GSE | Engine |
| <u>g</u> | Engine Control Valve--Closing solenoid energizing signal (input) | GSE | Engine | | | | |

Figure 2-23. Electrical Interface Requirements (Sheet 1 of 14)

| Pin | Functional Description | Signal | | Pin | Functional Description | Signal | |
|------------------------------|---|--------|-------------|------------------|---|--------|-------------|
| | | Origin | Termination | | | Origin | Termination |
| <u>r</u> | Checkout Valve-- Signal indicating valve in engine return position (output) | Engine | GSE | D | Redundant Shutdown Valve--28 vdc power energizing signal (input) | GSE | Engine |
| <u>s</u> | Checkout Valve-- Signal indicating valve in ground return position (output) | Engine | GSE | E | Spare | | |
| <u>t</u> | Checkout Valve-- Ground return for motor on checkout valve | Engine | GSE | F | Spare | | |
| <u>u</u> thru <u>y</u> | Spares | | | H | Spare | | |
| <u>z</u> | Shielded Termina- tion--Connects engine shielding to GSE shielding | | | H | Redundant Shutdown Valve--Monitoring signal | Engine | GSE |
| | <u>CONNECTOR J-19:</u> Connector equivalent to an MS3101R20-33P with 11 contacts, size AWG #16 | | | H ^(a) | Spare | | |
| A | Spare | | | J | Spare | | |
| B | Hypergol Car- tridge--28 vdc power to car- tridge switch common ter- minal (input) | GSE | Engine | K | Spare | | |
| C | Hypergol Car- tridge--Signal indicating hy- pergol cartridge installed (output) | Engine | GSE | | | | |

(a) Engines incorporating MD152 change

| Pin | Functional Description | Signal | | Pin | Functional Description | Signal | |
|----------|---|--------|-------------|----------|---|----------------|-------------|
| | | Origin | Termination | | | Origin | Termination |
| L | Spare | | | V | Vehicle Power Supply--Negative return from GSE and engine control valve closing solenoid | Engine and GSE | Stage |
| L | Redundant Shutdown Valve--Negative return | Engine | GSE | W | Spare | | |
| M | Shield Termination-- Connects engine shielding to GSE shielding | | | X | Spare | | |
| | <u>CONNECTOR J-20:</u> Connector equivalent to an MS3101R28-12P with 26 contacts, size AWG #16 | | | Y | Vehicle Power Supply-- Provides vehicle power to GSE | Stage | GSE |
| | | | | Z | Spare | | |
| | | | | <u>a</u> | Spare | | |
| | | | | <u>b</u> | Shielded Termination-- Connects engine shielding to stage shielding | | |
| A thru D | Spares | | | <u>d</u> | Engine Control Valve-- Closing solenoid energizing signal from vehicle; signal time duration to 100 ms (input) | Stage | Engine |
| E | No. 1 Thrust OK Pressure Switch-- Signal Indicating engine is not up to full thrust (output) | Engine | GSE | | <u>CONNECTOR J-100:</u> Connector equivalent to an MS3101R20-16P with 9 contacts, sizes 2 AWG #12 and 7 AWG #16 | | |
| F | No. 1 Thrust OK Pressure Switch-- 28 vdc power (input) | GSE | Engine | A | Positive 28 VDC Power Source for Primary Instrumentation System | Stage | Engine |
| G | No. 1 Thrust OK Pressure Switch-- Signal indicating engine has developed satisfactory thrust (output) | Engine | GSE | B | 28 VDC Power Return for Primary Instrumentation System | Stage | Engine |
| H thru U | Spares | | | C | Positive 28 VDC Duplicate Power for Primary Instrumentation Valve Position Switches | Stage | Engine |
| | | | | D | 5 VDC Duplicate Power Return and Pressure Transducer Signal Return for Primary Instrumentation System | Stage | Engine |

Figure 2-23. Electrical Interface Requirements (Sheet 3 of 14)

| Pin | Functional Description | Signal | | Pin | Functional Description | Signal | |
|----------|---|--------|-------------|-----|---|--------|-------------|
| | | Origin | Termination | | | Origin | Termination |
| E thru H | Spares | | | L | Combustion Chamber Pressure Transducer Signal Output (D-8) | Engine | Stage |
| I | Shield Return for Primary Instrumentation System | Engine | Stage | M | Combustion Chamber Pressure Transducer 20-Percent Calibration and Checkout Voltage Input (D-8) | GSE | Engine |
| | <u>CONNECTOR J-101:</u> Connector equivalent to an MS3101R28-21P with 37 contacts, size 37 AWG #16 | | | N | Combustion Chamber Pressure Transducer 80-Percent Calibration and Checkout Voltage Input (D-8) | GSE | Engine |
| A | Positive 28 VDC Duplicate Power Source for Primary Instrumentation System | Stage | Engine | P | Spare | | |
| B | 28 VDC Duplicate Power Return for Primary Instrumentation System | Stage | Engine | R | Spare | | |
| C | Positive 28 VDC Duplicate Power Source for Primary Instrumentation System Valve Position Switches | Stage | Engine | S | Common Hydraulic Return Pressure Transducer 20-Percent Calibration and Checkout Voltage Input (D-126) | GSE | Engine |
| D | 5 VDC Duplicate Power Return and Pressure Transducer Signal Return for Primary Instrumentation System | Stage | Engine | T | Turbine Outlet Pressure Transducer Signal Output (D-10) | Engine | Stage |
| E thru J | Spares | | | U | Turbine Outlet Pressure Transducer 20-Percent Calibration and Checkout Voltage Input (D-10) | GSE | Engine |
| K | Common Hydraulic Return Pressure Transducer 80-Percent Calibration and Checkout Voltage Input (D-126) | GSE | Engine | | | | |

Figure 2-23. Electrical Interface Requirements (Sheet 4 of 14)

| Pin | Functional Description | Signal | | Pin | Functional Description | Signal | |
|----------|---|--------|-------------|----------|---|--------|-------------|
| | | Origin | Termination | | | Origin | Termination |
| V | Turbine Outlet Pressure Transducer 80-Percent Calibration and Checkout Voltage Input (D-10) | GSE | Engine | <u>e</u> | Fuel Pump Inlet No. 1 Pressure Transducer Signal Output (D-4) | Engine | Stage |
| W | Gas Generator Chamber Pressure Transducer 20-Percent Calibration and Checkout Voltage Input (D-9) | GSE | Engine | <u>f</u> | Gas Generator Chamber Pressure Transducer Signal Output (D-9) | Engine | Stage |
| X | Gas Generator Chamber Pressure Transducer 80-Percent Calibration and Checkout Voltage Input (D-9) | GSE | Engine | <u>g</u> | LOX Pump Discharge No. 2 Pressure Transducer 20-Percent Calibration and Checkout Voltage Input (D-3) | GSE | Engine |
| Z | Spare | | | <u>h</u> | Fuel Pump Discharge No. 2 Pressure Transducer Signal Output (D-7) | Engine | Stage |
| <u>a</u> | Common Hydraulic Return Pressure Transducer Signal Output (D-126) | Engine | Stage | <u>i</u> | Fuel Pump Discharge No. 2 Pressure Transducer 20-Percent Calibration and Checkout Voltage Input (D-7) | GSE | Engine |
| <u>b</u> | LOX Pump Bearing Jet Pressure Transducer Signal Output (D-13) | Engine | Stage | <u>k</u> | Fuel Pump Inlet No. 1 Pressure Transducer 20-Percent Calibration and Checkout Voltage Input (D-4) | GSE | Engine |
| <u>c</u> | LOX Pump Bearing Jet Pressure Transducer 20-Percent Calibration and Checkout Voltage Input (D-13) | GSE | Engine | <u>m</u> | Fuel Pump Inlet No. 1 Pressure Transducer 80-Percent Calibration and Checkout Voltage Input (D-4) | GSE | Engine |
| <u>d</u> | LOX Pump Bearing Jet Pressure Transducer 80-Percent Calibration and Checkout Voltage Input (D-13) | GSE | Engine | <u>n</u> | LOX Pump Discharge No. 2 Pressure Transducer 80-Percent Calibration and Checkout Voltage Input (D-3) | GSE | Engine |
| | | | | <u>p</u> | LOX Pump Discharge No. 2 Pressure Transducer Signal Output (D-3) | Engine | Stage |

Figure 2-23. Electrical Interface Requirements (Sheet 5 of 14)

| Pin | Functional Description | Signal | | Pin | Functional Description | Signal | |
|----------|---|--------|-------------|------|--|--------|-------------|
| | | Origin | Termination | | | Origin | Termination |
| <u>r</u> | Fuel Pump Discharge No. 2 Pressure Transducer 80-Percent Calibration and Checkout Voltage Input (D-7) | GSE | Engine | H | No. 2 Main LOX Valve Position Potentiometer Signal Output (K-10) | Engine | Stage |
| <u>s</u> | Shield Return | Engine | Stage | J | Positive 5 VDC Excitation for No. 2 Main LOX Valve Position Potentiometer (K-10) | Engine | Engine |
| | <u>CONNECTOR J102:</u> Connector equivalent to an MS3101R22-14P with 19 contacts, size 19 AWG #16 | | | K | Spares | | |
| A | Spare | | | thru | | | |
| B | No. 1 Main Fuel Valve Position Potentiometer Signal Output (K-7) | Engine | Stage | N | | | |
| C | Positive 5 VDC Excitation for No. 1 Main Fuel Position Potentiometer (K-7) | Stage | Engine | P | 5 VDC Return for No. 1 Main Fuel Valve Position Potentiometer (K-7) | Stage | Engine |
| D | No. 2 Main Fuel Valve Position Potentiometer Signal Output (K-8) | Engine | Stage | R | Positive 5 VDC Excitation for No. 2 Main Fuel Valve Position Potentiometer (K-8) | Stage | Engine |
| E | Output Signal No. 1 Main LOX Valve Position Potentiometer Signal Output (K-9) | Engine | Stage | S | 5 VDC Return for No. 2 Main Fuel Valve Position Potentiometer (K-8) | Stage | Engine |
| F | Positive 5 VDC Excitation for No. 1 Main LOX Valve Position Potentiometer (K-9) | Stage | Engine | T | 5 VDC Return for No. 2 Main LOX Valve Position Potentiometer (K-10) | Stage | Engine |
| G | 5 VDC Return for No. 1 Main LOX Valve Position Potentiometer (K-9) | Stage | Engine | U | Spare | | |
| | | | | V | Shield Return | Engine | Stage |
| | | | | | <u>CONNECTOR J-103:</u> Connector equivalent to an MS3101R22-14S with 19 contacts, size 19 AWG #16 | | |
| | | | | A | Spare | | |
| | | | | B | Spare | | |

Figure 2-23. Electrical Interface Requirements (Sheet 6 of 14)

| Pin | Functional Description | Signal | | Pin | Functional Description | Signal | |
|----------|--|--------|-------------|--|---|--------|-------------|
| | | Origin | Termination | | | Origin | Termination |
| C | Gas Generator Valve Limit Switch Open Signal (K-6) | Engine | Stage | U | Spare | | |
| D | Gas Generator Valve Limit Switch Closed Signal (K-6) | Engine | Stage | V | Shield Return | Engine | Stage |
| E | No. 1 Main Fuel Valve Limit Switch Open Signal (K-7) | Engine | Stage | <u>CONNECTOR J-104:</u> Connector equivalent to an MS3101R20-27P with 14 contacts, size 14 AWG #16 | | | |
| F | No. 1 Main Fuel Valve Limit Switch Closed Signal (K-7) | Engine | Stage | | | | |
| G | No. 2 Main Fuel Valve Limit Switch Open Signal (K-8) | Engine | Stage | A | Spare | | |
| H | No. 2 Main Fuel Valve Limit Switch Closed Signal (K-8) | Engine | Stage | B | Spare | | |
| J | No. 2 Main LOX Valve Limit Switch Open Signal (K-10) | Engine | Stage | C | Turbopump Tachometer Signal Output, (T-1). Signal frequency is proportional to turbopump angular speed. | Engine | Stage |
| K thru N | Spares | | | D | Turbopump Tachometer Calibration and Checkout Voltage Input (T-1) | GSE | Engine |
| P | Vehicle Engine Cutoff Signal Received at Engine Cutoff Solenoid (Reference) (K-13) | Engine | Stage | E | Heat Exchanger LOX Inlet Flowmeter ±Signal Output (T-44) | Engine | Stage |
| R | Closed Signal, No. 1 Main LOX Valve Limit Switch (K-9) | Engine | Stage | F | Heat Exchanger Inlet Flowmeter Signal Output (T-44) | Engine | Stage |
| S | No. 1 Main LOX Valve Limit Switch Open Signal (K-9) | Engine | Stage | | | | |
| T | No. 2 Main LOX Valve Limit Switch Closed Signal (K-10) | Engine | Stage | | | | |

Figure 2-23. Electrical Interface Requirements (Sheet 7 of 14)

| Pin | Functional Description | Signal | | Pin | Functional Description | Signal | |
|----------|--|--------|-------------|-----|--|--------|-------------|
| | | Origin | Termination | | | Origin | Termination |
| G | Heat Exchanger LOX Inlet Flowmeter Calibration and Checkout Voltage Input (T-44) | GSE | Engine | C | Turbine Inlet Temperature Resistance Thermometer Sensor Output (C-3) | Stage | Engine |
| H | Heat Exchanger LOX Inlet Flowmeter Calibration and Checkout Voltage Input (T-44) | GSE | Engine | D | LOX Pump Bearing No. 1 Temperature Resistance Thermometer, Input Common (C-6) | Stage | Engine |
| I thru K | Spare | | | E | LOX Pump Bearing No. 1 Temperature Resistance Thermometer, Output Common (C-6) | Engine | Stage |
| L | Turbopump Tachometer Signal Output (T-1). Signal frequency is proportional to turbopump angular speed. | Engine | GSE | F | Engine Environmental Temperature Resistance Thermometer, Input Common (C-943) | Stage | Engine |
| M | Turbopump Tachometer Calibration and Checkout Voltage Input (T-1) | GSE | Engine | G | Engine Environmental Temperature Resistance Thermometer, Output Common (C-943) | Engine | Stage |
| N | Shield Return | Engine | Stage | H | LOX Pump Bearing No. 2 Temperature Resistance Thermometer Sensor Output (C-7) | Stage | Engine |
| | <u>CONNECTOR J-106:</u> Connector equivalent to an MS3101R20-29P with 17 contacts, size 17 AWG #16 | | | | | | |
| A | Spare | | | | | | |
| B | Spare | | | | | | |

Figure 2-23. Electrical Interface Requirements (Sheet 8 of 14)

| Pin | Functional Description | Signal | | Pin | Functional Description | Signal | |
|-----|--|--------|-------------|---|---|--------|-------------|
| | | Origin | Termination | | | Origin | Termination |
| H | Engine Environmental Temperature Resistance Thermometer, Sensor Output (C-943) | Engine | Stage | <u>CONNECTOR J-140:</u> ^(b) Connector equivalent to an MS3101R16S-8P with 5 contacts, size 5 AWG #16 | | | |
| J | Spare | | | A | Positive 28 VDC Duplicate Power for Auxiliary Instrumentation System | Stage | Engine |
| K | Spare | | | B | 28 VDC Duplicate Power Return for Auxiliary Instrumentation System | Stage | Engine |
| L | Spare | | | C | Spare | | |
| M | Spare | | | D | 5 VDC Duplicate Return and Pressure Transducer Signal Return for Auxiliary Instrumentation System | Stage | Engine |
| N | Turbine Inlet Temperature Resistance Thermometer Input Common (C-3) | Stage | Engine | E | Shield Return for Auxiliary Instrumentation System | Engine | Stage |
| P | Turbine Inlet Temperature Resistance Thermometer Output Common (C-3) | Engine | Stage | <u>CONNECTOR J-141:</u> ^(b) Connector equivalent to an MS3101R36-7P with 47 contacts, sizes 40 AWG #16 and 7 AWG #12 | | | |
| R | LOX Pump Bearing No. 1 Temperature Resistance Thermometer, Sensor Output (C-6) | Stage | Engine | A | Positive 28 VDC Duplicate Power Source for Auxiliary Instrumentation System | Stage | Engine |
| S | Turbine Bearing Temperature Resistance Thermometer, Sensor Output (C-8) | Stage | Engine | B | 28 VDC Duplicate Power Return for Auxiliary Instrumentation System | Stage | Engine |
| S | Spare | | | C | 28 VDC Duplicate Power Return for Auxiliary Instrumentation System | Stage | Engine |
| T | Shield Return | Engine | Stage | | | | |

(b) Engines not incorporating MD96 or MD97 change

Figure 2-23. Electrical Interface Requirements (Sheet 9 of 14)

| Pin | Functional Description | Signal | | Pin | Functional Description | Signal | |
|-----|---|--------|-------------|-----|--|--------|-------------|
| | | Origin | Termination | | | Origin | Termination |
| D | 5 VDC Duplicate Power Return and Pressure Transducer Output Common for Auxiliary Instrumentation System | Stage | Engine | L | LOX Pump Discharge No. 1 Pressure Transducer 80-Percent Calibration and Checkout Voltage Input (D-2) | GSE | Engine |
| E | Spare | | | M | Engine Control Closing Pressure Transducer 20-Percent Calibration and Checkout Voltage Input (D-11) | GSE | Engine |
| F | LOX Pump Discharge No. 1 Pressure Transducer Signal Output (D-2) | Engine | Stage | N | Engine Control Opening Pressure Transducer Signal Output (D-12) | Engine | Stage |
| G | Spare | | | O | Spare | | |
| H | LOX Pump Discharge No. 1 Pressure Transducer 20-Percent Calibration and Checkout Voltage Input (D-2) | GSE | Engine | P | Spare | | |
| I | Spare | | | R | Engine Control Closing Pressure Transducer 80-Percent Calibration and Checkout Voltage Input (D-11) | GSE | Engine |
| J | Output Signal, Engine Control Closing Pressure Transducer (D-11) | Engine | Stage | S | Engine Control Opening Pressure Transducer 20-Percent Calibration and Checkout Voltage Input (D-12) | GSE | Engine |
| K | Spare | | | T | Fuel Pump Discharge No. 1 Pressure Transducer Signal Output (D-6) | Engine | Stage |
| | | | | U | Spare | | |
| | | | | V | Spare | | |
| | | | | W | Engine Control Opening Pressure Transducer 80-Percent Calibration and Checkout Voltage Input (D-12) | GSE | Engine |
| | | | | X | Spare | | |

Figure 2-23. Electrical Interface Requirements (Sheet 10 of 14)

| Pin | Functional Description | Signal | | Pin | Functional Description | Signal | |
|----------|---|--------|-------------|------------------------------|---|--------|-------------|
| | | Origin | Termination | | | Origin | Termination |
| <u>Y</u> | Heat Exchanger Helium Inlet Pressure Transducer Signal Output (D-19) | Engine | Stage | <u>j</u> | Heat Exchanger Helium Inlet Pressure Transducer 80-Percent Calibration and Checkout Voltage Input (D-19) | GSE | Engine |
| <u>Z</u> | Spare | | | <u>k</u> | LOX Pump Seal Cavity Pressure 80-Percent Calibration and Checkout Voltage Input (D-142) | GSE | Engine |
| <u>a</u> | Heat Exchanger Helium Inlet Pressure Transducer Signal Output (D-20) | Engine | Stage | <u>m</u> | Heat Exchanger LOX Inlet Pressure Transducer Signal Output (D-17) | Engine | Stage |
| <u>b</u> | Spare | | | <u>n</u> | Heat Exchanger Gaseous Oxygen Outlet Pressure Transducer 20-Percent Calibration and Checkout Voltage Input (D-18) | GSE | Engine |
| <u>c</u> | LOX Pump Seal Cavity Pressure Transducer Signal Output (D-142) | Engine | Stage | <u>p</u> | Heat Exchanger LOX Inlet Pressure Transducer 20-Percent Calibration and Checkout Voltage Input (D-17) | GSE | Engine |
| <u>d</u> | Heat Exchanger Helium Inlet Pressure Transducer 20-Percent Calibration and Checkout Voltage Input (D-19) | GSE | Engine | <u>r</u> | Heat Exchanger Gaseous Oxygen Outlet Pressure Transducer 80-Percent Calibration and Checkout Voltage Input (D-18) | GSE | Engine |
| <u>e</u> | Heat Exchanger Helium Outlet Pressure Transducer 20-Percent Calibration and Checkout Voltage Input (D-20) | GSE | Engine | <u>s</u> | Heat Exchanger LOX Inlet Pressure 80-Percent Calibration and Checkout Voltage Input (D-17) | GSE | Engine |
| <u>f</u> | Heat Exchanger Helium Outlet Pressure Transducer 80-Percent Calibration and Checkout Voltage Input (D-20) | GSE | Engine | <u>t</u> thru <u>Y</u> | Spares | | |
| <u>g</u> | LOX Pump Seal Cavity Pressure Transducer 20-Percent Calibration and Checkout Voltage Input (D-142) | GSE | Engine | <u>z</u> | Shield Return | Engine | Stage |
| <u>h</u> | Heat Exchanger Gaseous Oxygen Outlet Pressure Transducer Output Signal (D-18) | Engine | Stage | | | | |

Figure 2-23. Electrical Interface Requirements (Sheet 11 of 14)

| Pin | Functional Description | Signal | | Pin | Functional Description | Signal | |
|---|---|--------|-------------|-----|---|--------|-------------|
| | | Origin | Termination | | | Origin | Termination |
| CONNECTOR J-142: | | | | J | Heat Exchanger LOX Inlet Temperature Resistance Thermometer Input Common (C-11) | Stage | Engine |
| A | No. 2 Thrust OK Pressure Switch-- Signal indicating engine is not up to full thrust (output) | Engine | GSE | K | Fuel Pump Inlet No. 2 Temperature Resistance Thermometer Input Common (C-24) | Stage | Engine |
| B | No. 2 Thrust OK Pressure Switch-- 28 vdc power (input) | GSE | Engine | L | Fuel Pump Inlet No. 2 Temperature Resistance Thermometer Output Common (C-24) | Engine | Stage |
| C | No. 2 Thrust OK Pressure Switch-- Signal indicating engine has developed satisfactory thrust (output) | Engine | GSE | M | Fuel Pump Inlet No. 2 Temperature Resistance Thermometer Sensor Output (C-24) | Stage | Engine |
| D | Shield Termination-- Connects engine shielding to S-IC stage shielding | | | N | Heat Exchanger LOX Inlet Temperature Resistance Thermometer Output Common (C-11) | Engine | Stage |
| CONNECTOR J-143: ^(b) Connector equivalent to an MS3101R24-28P with 28 contacts, size 24 AWG #16 | | | | P | Heat Exchanger LOX Inlet Temperature Resistance Thermometer Sensor Output (C-11) | Stage | Engine |
| A thru H | Spares | | | Q | Heat Exchanger Helium Outlet Temperature Resistance Thermometer Input Common (C-13) | Stage | Engine |
| | | | | R | Heat Exchanger Gaseous Oxygen Outlet Temperature Resistance Thermometer Input Common (C-12) | Stage | Engine |

(b) Engines not incorporating MD96 or MD97 change

Figure 2-23. Electrical Interface Requirements (Sheet 12 of 14)

| Pin | Functional Description | Signal | | Pin | Functional Description | Signal | |
|-------------------------|---|--------|-------------|---------|---|--------|-------------|
| | | Origin | Termination | | | Origin | Termination |
| S | Heat Exchanger Gaseous Oxygen Outlet Temperature Resistance Thermometer Output Common (C-12) | Engine | Stage | | CONNECTOR J-470: Connector equivalent to an MS3101R28-12P with 26 contacts, size AWG #16 | | |
| T | Heat Exchanger Gaseous Oxygen Outlet Temperature Resistance Thermometer Sensor Output (C-12) | Stage | Engine | A | Spare | | |
| U | Heat Exchanger Helium Outlet Temperature Resistance Thermometer Output Common (C-13) | Engine | Stage | B | Gas Generator Igniter No. 1 and No. 2-- Continuity-checks through igniter links No. 1 and No. 2 indicating igniters installed (input) | GSE | Engine |
| V | Heat Exchanger Helium Outlet Temperature Resistance Thermometer Sensor Outlet (C-13) | Stage | Engine | C | Gas Generator Igniter No. 1 and No. 2-- Continuity-checks through igniter links No. 1 and No. 2 indicating igniters installed (input) | GSE | Engine |
| W thru Y | Spares | | | D | Turbine Exhaust Igniter No. 1--500 vac to turbine exhaust igniter No. 1 (input) | Engine | GSE |
| Z | Shield Return | Engine | Stage | E and F | Spares | | |
| <u>CONNECTOR J-174:</u> | | | | G | Gas Generator Igniter No. 2-- 500 vac to gas generator igniter No. 2 squib (input) | GSE | Engine |
| A | No. 3 Thrust OK Pressure Switch-- Signal indicating engine is not up to full thrust (output) | Engine | GSE | H | Spare | | |
| B | No. 3 Thrust OK Pressure Switch-- 28 vdc power (input) | GSE | Engine | J | Turbine Exhaust Igniter No. 2-- 500 vac to turbine exhaust igniter No. 2 squib (input) | GSE | Engine |
| C | No. 3 Thrust OK Pressure Switch-- Signal indicating engine has developed satisfactory thrust (output) | Engine | GSE | K | Spare | | |
| D | Spare | | | L | Spare | | |
| E | Shielding Termination-- Connects engine shielding to S-1C stage shielding | | | | | | |

Figure 2-23. Electrical Interface Requirements (Sheet 13 of 14)

| Pin | Functional Description | Signal | | Pin | Functional Description | Signal | |
|---------|--|--------|-------------|----------|---|--------|-------------|
| | | Origin | Termination | | | Origin | Termination |
| M | Gas Generator Igniter No. 1--500 vac to gas generator igniter No. 1 squib (input) | GSE | Engine | <u>a</u> | Gas Generator Igniter No. 1--500 vac to gas generator igniter No. 1 squib (input) | GSE | Engine |
| N | Spare | | | <u>b</u> | Spare | | |
| P | Turbine Exhaust Igniter No. 1 and No. 2--Continuity-checks through igniter links No. 1 and No. 2 indicating igniters installed (input) | GSE | Engine | <u>d</u> | Shield Termination-- Connects engine shielding to GSE shielding | Engine | GSE |
| R | Turbine Exhaust Igniter No. 1 and No. 2--Continuity-checks through igniter links No. 1 and No. 2 indicating igniters installed | GSE | Engine | | CONNECTOR J-800: Connector equivalent to an MS3101R18-1P with 10 contacts, size AWG #16 | | |
| S | Spare | | | A and B | Spare | | |
| T | Turbine Exhaust Igniter No. 1--500 vac to turbine exhaust igniter No. 1 squib (input) | GSE | Engine | C | Turbopump Heater No. 1--208 vac power to turbopump heater No. 1 (input) | GSE | Engine |
| U | Spare | | | D | Turbopump Heater No. 1--208 vac power to turbopump heater No. 1 (input) | GSE | Engine |
| V | Gas Generator Igniter No. 2--500 vac to gas generator igniter No. 2 squib (input) | GSE | Engine | E | Turbopump Heater No. 2--208 vac power to turbopump heater No. 2 (input) | GSE | Engine |
| W and X | Spare | | | F | Turbopump Heater No. 2--208 vac power to turbopump heater No. 2 (input) | GSE | Engine |
| Y | Turbine Exhaust Igniter No. 2--500 vac to turbine exhaust igniter No. 2 squib (input) | GSE | Engine | G thru I | Spare | | |
| Z | Spare | | | J | Shield Termination-- Connects engine shielding to GSE shielding | Engine | GSE |

Figure 2-23. Electrical Interface Requirements (Sheet 14 of 14)

2-47. INSTRUMENTATION TAP LOCATIONS AND IDENTIFICATION.

2-48. TAP CODE IDENTIFICATION SYSTEM. Tap locations are shown in figure 2-24. The code identification system is as follows:

- A, actuator
- C, thrust chamber
- G, gas generator
- H, heat exchanger
- I, igniter fuel injection
- K, low-pressure propellant
- L, turbopump
- N, control system
- P, main propellant
- T, turbine
- W, gimbal

The second-column capital letter designates the medium being sensed or the operating feature connected with the tap as follows:

- F, propellant fuel
- G, high-temperature gas
- H, hydraulic control liquid or helium
- L, lubricant
- S, metal temperature
- B, bearing
- O, propellant oxidizer

The third-column number identifies the tap on the component or in the system.

The fourth-column lower case letter signifies more than one tap of the same measurement.

The fifth-column number signifies that the tap location is duplicated on both the No. 1 and No. 2 sides of the engine.

2-49. ACCELEROMETER CODE IDENTIFICATION SYSTEM. Accelerometer locations are shown in figure 2-24. The code identification system is as follows:

The first-column capital letter designates major component or basic support system as follows:

- C, thrust chamber
- P, turbopump
- M, interface panel

The second-column capital letter designates the medium being sensed or the operating feature connected with the tap as follows:

- Z, no fluid medium involved

The third-column capital letter identifies the type of measuring instrument as follows:

- A, accelerometer

The fourth-column number identifies the tap on the component or in the system.

The fifth-column letter identifies the axis sensitivity of the accelerometer.

Pages 2-39 through 2-46 deleted.

| Pin | Functional Description | Signal | | Voltage Level | Maximum Load |
|------|---|--------|-------------|------------------|---|
| | | Origin | Termination | | |
| C | 28 VDC Duplicate Power Return for Auxiliary Instrumentation System | Stage | Engine | Ground potential | 2.86 amps maximum at 28 vdc on positive bus |
| D | 5 VDC Duplicate Power Return and Pressure Transducer Output Common for Auxiliary Instrumentation System | Stage | Engine | Ground potential | 0.1 amp maximum |
| E | Turbine Outlet Pressure Transducer Signal Output (D-10) | Engine | Stage | 0-5 vdc | 100,000 \pm 2,000 ohms telemetry |
| E(e) | Spare | | | | |
| F | LOX Pump Discharge No. 1 Pressure Transducer Signal Output (D-2) | Engine | Stage | 0-5 vdc | 100,000 \pm 2,000 ohms telemetry |
| G | Turbine Outlet Pressure Transducer 20-Percent Calibration and Checkout Voltage Input (D-10) | GSE | Engine | 24-32 vdc | 71.5 milli-amperes maximum at 28 vdc |
| G(e) | Spare | | | | |
| H | LOX Pump Discharge No. 1 Pressure Transducer 20-Percent Calibration and Checkout Voltage Input (D-2) | GSE | Engine | 24-32 vdc | 71.5 milli-amperes maximum at 28 vdc |
| I | Turbine Outlet Pressure Transducer 80-Percent Calibration and Checkout Voltage Input (D-10) | GSE | Engine | 24-32 vdc | 71.5 milli-amperes maximum at 28 vdc |
| I(e) | Spare | | | | |
| J | Output Signal, Engine Control Closing Pressure Transducer (D-11) | Engine | Stage | 0-5 vdc | 100,000 \pm 2,000 ohms telemetry |
| K | Spare | | | | |
| L | LOX Pump Discharge No. 1 Pressure Transducer 80-Percent Calibration and Checkout Voltage Input (D-2) | GSE | Engine | 24-32 vdc | 71.5 milli-amperes maximum at 28 vdc |

(e) Engines incorporating MD31 or MD108 change.

Figure 2-23. Electrical Interface Requirements (Sheet 16 of 23)

| Pin | Functional Description | Signal | | Voltage Level | Maximum Load |
|----------|--|--------|-------------|---------------|-------------------------------------|
| | | Origin | Termination | | |
| M | Engine Control Closing Pressure Transducer 20-Percent Calibration and Check-out Voltage Input (D-11) | GSE | Engine | 24-32 vdc | 71.5 milliamperes maximum at 28 vdc |
| N | Engine Control Opening Pressure Transducer Signal Output (D-12) | Engine | Stage | 0-5 vdc | 100,000 \pm 2,000 ohms telemetry |
| O and P | Spare | | | | |
| R | Engine Control Closing Pressure Transducer 80-Percent Calibration and Check-out Voltage Input (D-11) | GSE | Engine | 24-32 vdc | 71.5 milliamperes maximum at 28 vdc |
| S | Engine Control Opening Pressure Transducer 20-Percent Calibration and Check-out Voltage Input (D-12) | GSE | Engine | 24-32 vdc | 71.5 milliamperes maximum at 28 vdc |
| T | Fuel Pump Discharge No. 1 Pressure Transducer Signal Output (D-6) | Engine | Stage | 0-5 vdc | 100,000 \pm 2,000 ohms telemetry |
| U and V | Spare | | | | |
| W | Engine Control Opening Pressure Transducer 80-Percent Calibration and Checkout Voltage Input (D-12) | GSE | Engine | 24-32 vdc | 71.5 milliamperes maximum at 28 vdc |
| X | Spare | | | | |
| Y | Heat Exchanger Helium Inlet Pressure Transducer Signal Output (D-19) | Engine | Stage | 0-5 vdc | 100,000 \pm 2,000 ohms telemetry |
| <u>a</u> | Heat Exchanger Helium Inlet Pressure Transducer Signal Output (D-20) | Engine | Stage | 0-5 vdc | 100,000 \pm 2,000 ohms telemetry |
| <u>b</u> | Spare | | | | |
| <u>c</u> | LOX Pump Seal Cavity Pressure Transducer Signal Output (D-142) | Engine | Stage | 0-5 vdc | 100,000 \pm 2,000 ohms telemetry |

Figure 2-23. Electrical Interface Requirements (Sheet 17 of 23)

| Pin | Functional Description | Signal | | Voltage Level | Maximum Load |
|----------|---|--------|-------------|---------------|--------------------------------------|
| | | Origin | Termination | | |
| <u>d</u> | Heat Exchanger Helium Inlet Pressure Transducer 20-Percent Calibration and Checkout Voltage Input (D-19) | GSE | Engine | 24-32 vdc | 71.5 milli-amperes maximum at 28 vdc |
| <u>e</u> | Heat Exchanger Helium Outlet Pressure Transducer 20-Percent Calibration and Checkout Voltage Input (D-20) | GSE | Engine | 24-32 vdc | 71.5 milli-amperes maximum at 28 vdc |
| <u>f</u> | Heat Exchanger Helium Outlet Pressure Transducer 80-Percent Calibration and Checkout Voltage Input (D-20) | GSE | Engine | 24-32 vdc | 71.5 milli-amperes maximum at 28 vdc |
| <u>g</u> | LOX Pump Seal Cavity Pressure Transducer 20-Percent Calibration and Checkout Voltage Input (D-142) | GSE | Engine | 24-32 vdc | 71.5 milli-amperes maximum at 28 vdc |
| <u>h</u> | Heat Exchanger Gaseous Oxygen Outlet Pressure Transducer Output Signal (D-18) | Engine | Stage | 0-5 vdc | 100,000 \pm 2,000 ohms telemetry |
| <u>j</u> | Heat Exchanger Helium Inlet Pressure Transducer 80-Percent Calibration and Checkout Voltage Input (D-19) | GSE | Engine | 24-32 vdc | 71.5 milli-amperes maximum at 28 vdc |
| <u>k</u> | LOX Pump Seal Cavity Pressure 80-Percent Calibration and Checkout Voltage Input (D-142) | GSE | Engine | 24-32 vdc | 71.5 milli-amperes maximum at 28 vdc |
| <u>m</u> | Heat Exchanger LOX Inlet Pressure Transducer Signal Output (D-17) | Engine | Stage | 0-5 vdc | 100,000 \pm 2,000 ohms telemetry |
| <u>n</u> | Heat Exchanger Gaseous Oxygen Outlet Pressure Transducer 20-Percent Calibration and Checkout Voltage Input (D-18) | GSE | Engine | 24-32 vdc | 71.5 milli-amperes maximum at 28 vdc |
| <u>p</u> | Heat Exchanger LOX Inlet Pressure Transducer 20-Percent Calibration and Checkout Voltage Input (D-17) | GSE | Engine | 24-32 vdc | 71.5 milli-amperes maximum at 28 vdc |

Figure 2-23. Electrical Interface Requirements (Sheet 18 of 23)

| Pin | Functional Description | Signal | | Voltage Level | Maximum Load |
|------------------------------|---|--------|-------------|------------------|---|
| | | Origin | Termination | | |
| <u>r</u> | Heat Exchanger Gaseous Oxygen Outlet Pressure Transducer 80-Percent Calibration and Checkout Voltage Input (D-18) | GSE | Engine | 24-32 vdc | 71.5 milliamperes maximum at 28 vdc |
| <u>s</u> | Heat Exchanger LOX Inlet Pressure 80-Percent Calibration and Checkout Voltage Input (D-17) | GSE | Engine | 24-32 vdc | 71.5 milliamperes maximum at 28 vdc |
| <u>t</u> thru <u>y</u> | Spares | | | | |
| <u>z</u> | Shield Return | Engine | Stage | Ground potential | Electrostatic shielding current |
| | <u>CONNECTOR J-143:</u> ^(h) Connector equivalent to an MS3101R24-28P with 28 contacts, size 24 AWG #16 | | | | |
| A thru H | Spares | | | | |
| J | Heat Exchanger LOX Inlet Temperature Resistance Thermometer Input Common (C-11) | Stage | Engine | Ground potential | Pin P; R _O pin P |
| K | Fuel Pump Inlet No. 2 Temperature Resistance Thermometer Input Common (C-24) | Stage | Engine | Ground potential | Pin M; R _O pin M |
| L | Fuel Pump Inlet No. 2 Temperature Resistance Thermometer Output Common (C-24) | Engine | Stage | Ground potential | Pin M; R _O pin M |
| M | Fuel Pump Inlet No. 2 Temperature Resistance Thermometer Sensor Output (C-24) | Stage | Engine | 350 millivolts | 1,160 to 1,530 ohms (R _O = 1,256 ±6 ohms) |
| N | Heat Exchanger LOX Inlet Temperature Resistance Thermometer Output Common (C-11) | Engine | Stage | Ground potential | Pin P; R _O pin P |

(h) Engines not incorporating MD96 or MD97 change.

Figure 2-23. Electrical Interface Requirements (Sheet 19 of 23)

| Pin | Functional Description | Signal | | Voltage Level | Maximum Load |
|----------|---|--------|-------------|------------------|--|
| | | Origin | Termination | | |
| P | Heat Exchanger LOX Inlet Temperature Resistance Thermometer Sensor Output (C-11) | Stage | Engine | 170 milli-volts | 295-450 ohms ($R_0 = 1,256 \pm 6$ ohms) |
| Q | Heat Exchanger Helium Outlet Temperature Resistance Thermometer Input Common (C-13) | Stage | Engine | Ground potential | Pin V; R_0 pin V |
| R | Heat Exchanger Gaseous Oxygen Outlet Temperature Resistance Thermometer Input Common (C-12) | Stage | Engine | Ground potential | Pin T; R_0 pin T |
| S | Heat Exchanger Gaseous Oxygen Outlet Temperature Resistance Thermometer Output Common (C-12) | Engine | Stage | Ground potential | Pin T R_0 pin T |
| T | Heat Exchanger Gaseous Oxygen Outlet Temperature Resistance Thermometer Sensor Output (C-12) | Stage | Engine | 100 milli-volts | 100-935 ohms ($R_0 = 425 \pm 2$ ohms) |
| U | Heat Exchanger Helium Outlet Temperature Resistance Thermometer Output Common (C-13) | Engine | Stage | Ground potential | Pin V; R_0 pin V |
| V | Heat Exchanger Helium Outlet Temperature Resistance Thermometer Sensor Outlet (C-13) | Stage | Engine | 100 milli-volts | 100-935 ohms ($R_0 = 425 \pm 2$ ohms) |
| W thru Y | Spares | | | | |
| Z | Shield Return | Engine | Stage | Ground potential | Electrostatic shielding current |
| | <u>CONNECTOR J-470:</u> Connector equivalent to an MS3101R28-12P with 26 contacts, size AWG #16 | | | | |
| A | Spare | | | | |
| B | Gas Generator Igniter No. 1 and No. 2-- Continuity-checks through igniter links No. 1 and No. 2 indicating igniters installed (input) | GSE | Engine | 24-32 vdc | 1 amp |

Figure 2-23. Electrical Interface Requirements (Sheet 20 of 23)

| Pin | Functional Description | Signal | | Voltage Level | Maximum Load |
|---------------|--|--------|-------------|---------------------------------|--------------|
| | | Origin | Termination | | |
| C | Gas Generator Igniter No. 1 and No. 2-- Continuity-checks through igniter links No. 1 and No. 2 indicating igniters in- stalled (input) | GSE | Engine | Ground potential | 1 amp |
| D | Turbine Exhaust Igniter No. 1--500 vac to turbine exhaust igniter No. 1 (input) | Engine | GSE | 500 vac, 60 cycle minimum | 3-6 amps |
| E and F | Spares | | | | |
| G | Gas Generator Igniter No. 2--500 vac to gas generator igniter No. 2 squib (input) | GSE | Engine | 500 vac, 60 cycle minimum | 3-6 amps |
| H | Spare | | | | |
| J | Turbine Exhaust Igniter No. 2--500 vac to turbine exhaust igniter No. 2 squib (input) | GSE | Engine | 500 vac, 60 cycle minimum | 3-6 amps |
| L | Spare | | | | |
| M | Gas Generator Igniter No. 1--500 vac to gas generator igniter No. 1 squib (input) | GSE | Engine | 500 vac, 60 cycle minimum | 3-6 amps |
| N | Spare | | | | |
| P | Turbine Exhaust Igniter No. 1 and No. 2-- Continuity-checks through igniter links No. 1 and No. 2 indicating igniters in- stalled (input) | GSE | Engine | 24-32 vdc | 1 amp |
| R | Turbine Exhaust Igniter No. 1 and No. 2-- Continuity-checks through igniter links No. 1 and No. 2 indicating igniters in- stalled | GSE | Engine | Ground potential | 1 amp |
| S | Spare | | | | |
| T | Turbine Exhaust Igniter No. 1--500 vac to turbine exhaust igniter No. 1 squib (input) | GSE | Engine | 500 vac, 60 cycle minimum | 3-6 amps |
| U | Spare | | | | |

Figure 2-23. Electrical Interface Requirements (Sheet 21 of 23)

| Pin | Functional Description | Signal | | Voltage Level | Maximum Load |
|----------|---|--------|-------------|---------------------------|---------------------------------|
| | | Origin | Termination | | |
| V | Gas Generator Igniter No. 2--500 vac to gas generator igniter No. 2 squib (input) | GSE | Engine | 500 vac, 60 cycle minimum | 3-6 amps |
| W and X | Spares | | | | |
| Y | Turbine Exhaust Igniter No. 2--500 vac to turbine exhaust igniter No. 2 squib (input) | GSE | Engine | 500 vac, 60 cycle minimum | 3-6 amp |
| Z | Spare | | | | |
| <u>a</u> | Gas Generator Igniter No. 1--500 vac to gas generator igniter No. 1 squib (input) | GSE | Engine | 500 vac, 60 cycle minimum | 3-6 amps |
| <u>b</u> | Spare | | | | |
| <u>d</u> | Shield Termination--Connects engine shielding to GSE shielding | Engine | GSE | Ground potential | Electrostatic shielding current |
| | <u>CONNECTOR J-800</u> : Connector equivalent to an MS3101R18-1P with 10 contacts, size AWG #16 | | | | |
| A and B | Spare | | | | |
| C | Turbopump Heater No. 1--208 vac power to turbopump heater No. 1 (input) | GSE | Engine | 190-220 vac 60 cycle | 1,500 watts |
| D | Turbopump Heater No. 1--208 vac power to turbopump heater No. 1 (input) | GSE | Engine | 190-220 vac 60 cycle | 1,500 watts |
| E | Turbopump Heater No. 2--208 vac power to turbopump heater No. 2 (input) | GSE | Engine | 190-220 vac 60 cycle | 1,500 watts |
| F | Turbopump Heater No. 2--208 vac power to turbopump heater No. 2 (input) | GSE | Engine | 190-220 vac 60 cycle | 1,500 watts |

Figure 2-23. Electrical Interface Requirements (Sheet 22 of 23)

| Pin | Functional Description | Signal | | Voltage Level | Maximum Load |
|----------|--|--------|-------------|------------------|---------------------------------|
| | | Origin | Termination | | |
| G thru I | Spare | | | | |
| J | Shield Termination--Connects engine shielding to GSE shielding | Engine | GSE | Ground potential | Electrostatic shielding current |

Figure 2-23. Electrical Interface Requirements (Sheet 23 of 23)

2-47. INSTRUMENTATION TAP LOCATIONS AND IDENTIFICATION.

The fourth-column lower case letter signifies more than one tap of the same measurement.

2-48. TAP CODE IDENTIFICATION SYSTEM. Tap locations are shown in figure 2-24. The code identification system is as follows:

The fifth-column number signifies that the tap location is duplicated on both the No. 1 and No. 2 sides of the engine.

- A, actuator
- C, thrust chamber
- G, gas generator
- H, heat exchanger
- I, igniter fuel injection
- K, low-pressure propellant
- L, turbopump
- N, control system
- P, main propellant
- T, turbine
- W, gimbal

2-49. ACCELEROMETER CODE IDENTIFICATION SYSTEM. Accelerometer locations are shown in figure 2-24. The code identification system is as follows:

The first-column capital letter designates major component or basic support system as follows:

- C, thrust chamber
- P, turbopump
- M, interface panel

The second-column capital letter designates the medium being sensed or the operating feature connected with the tap as follows:

The second-column capital letter designates the medium being sensed or the operating feature connected with the tap as follows:

- Z, no fluid medium involved

- F, propellant fuel
- G, high-temperature gas
- H, hydraulic control liquid
- L, lubricant
- S, metal temperature
- B, bearing
- O, propellant oxidizer

The third-column capital letter identifies the type of measuring instrument as follows:

- A, accelerometer

The third-column number identifies the tap on the component or in the system.

The fourth-column number identifies the tap on the component or in the system.

The fifth-column letter identifies the axis sensitivity of the accelerometer.

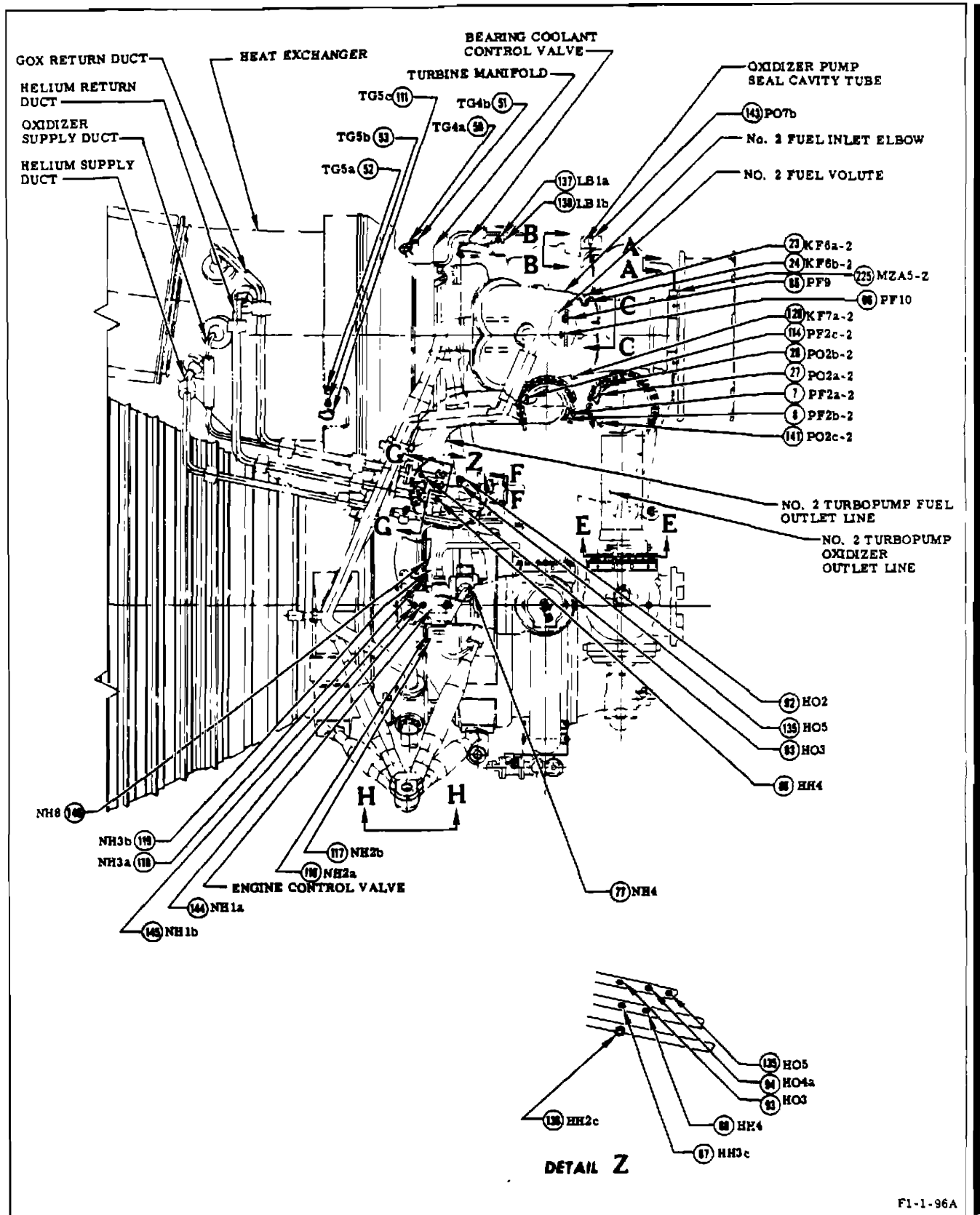
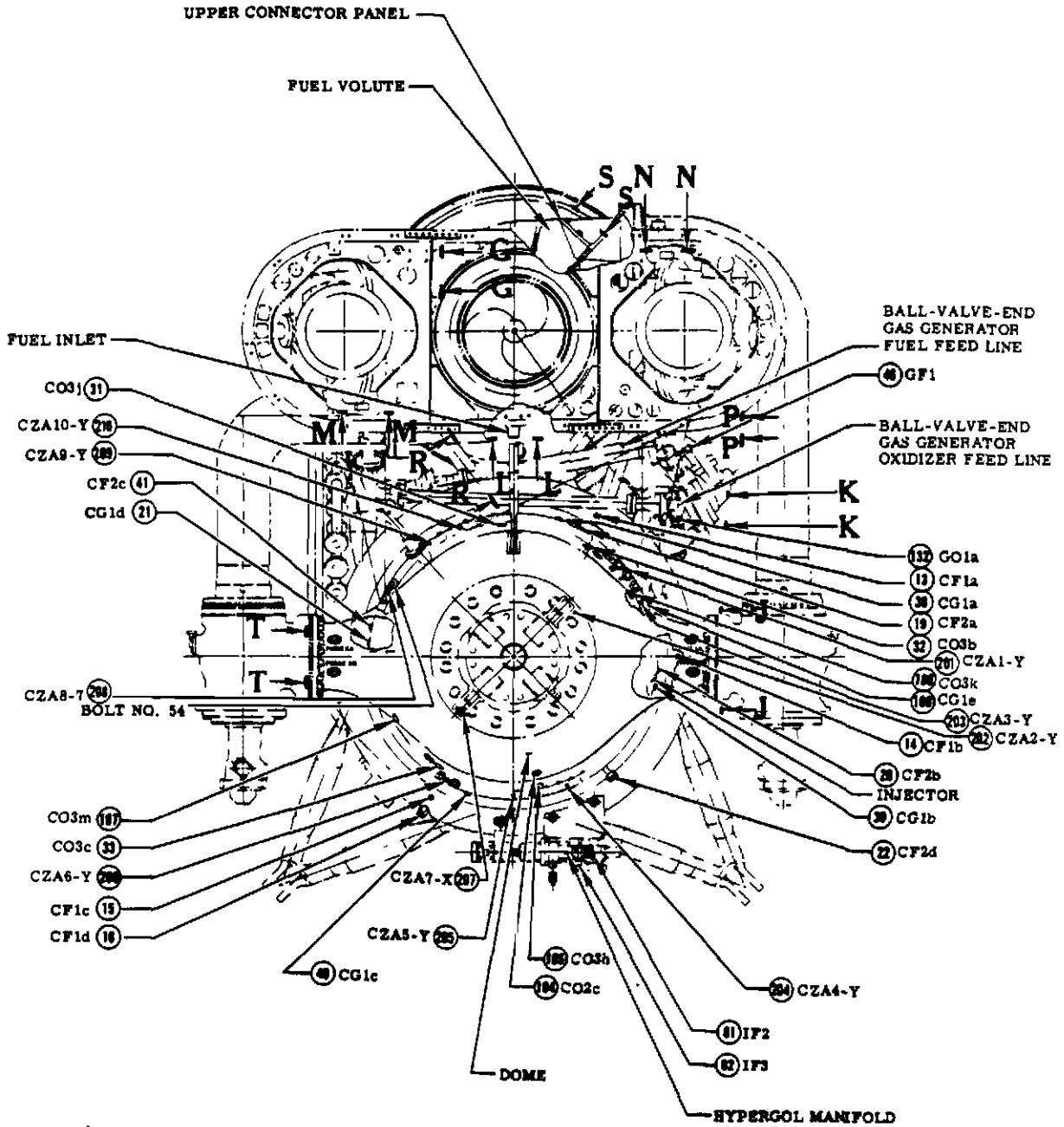

Figure 2-24. Instrumentation Tap Locations (Sheet 1 of 8)



F1-1-97B

Figure 2-24. Instrumentation Tap Locations (Sheet 2 of 8)

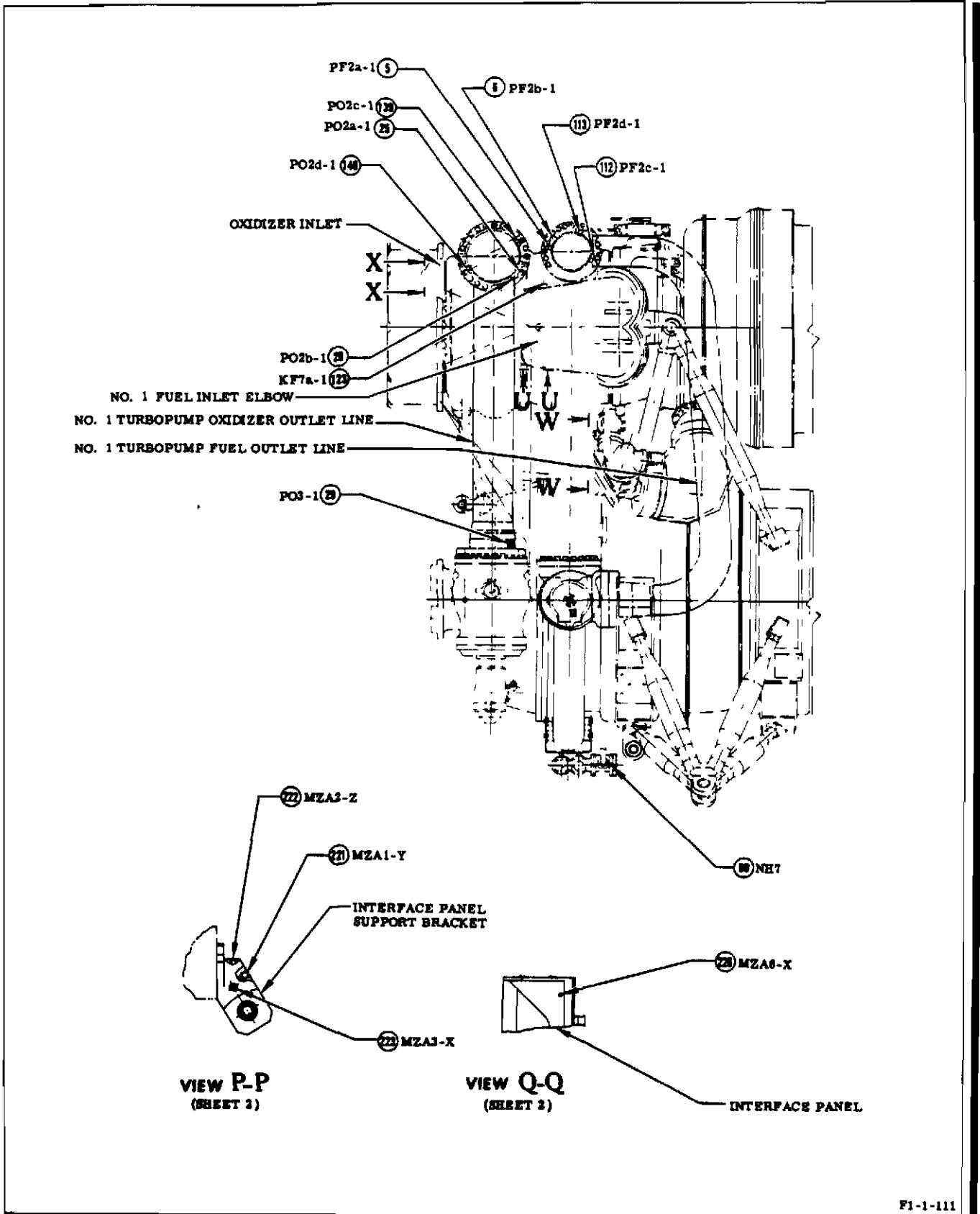
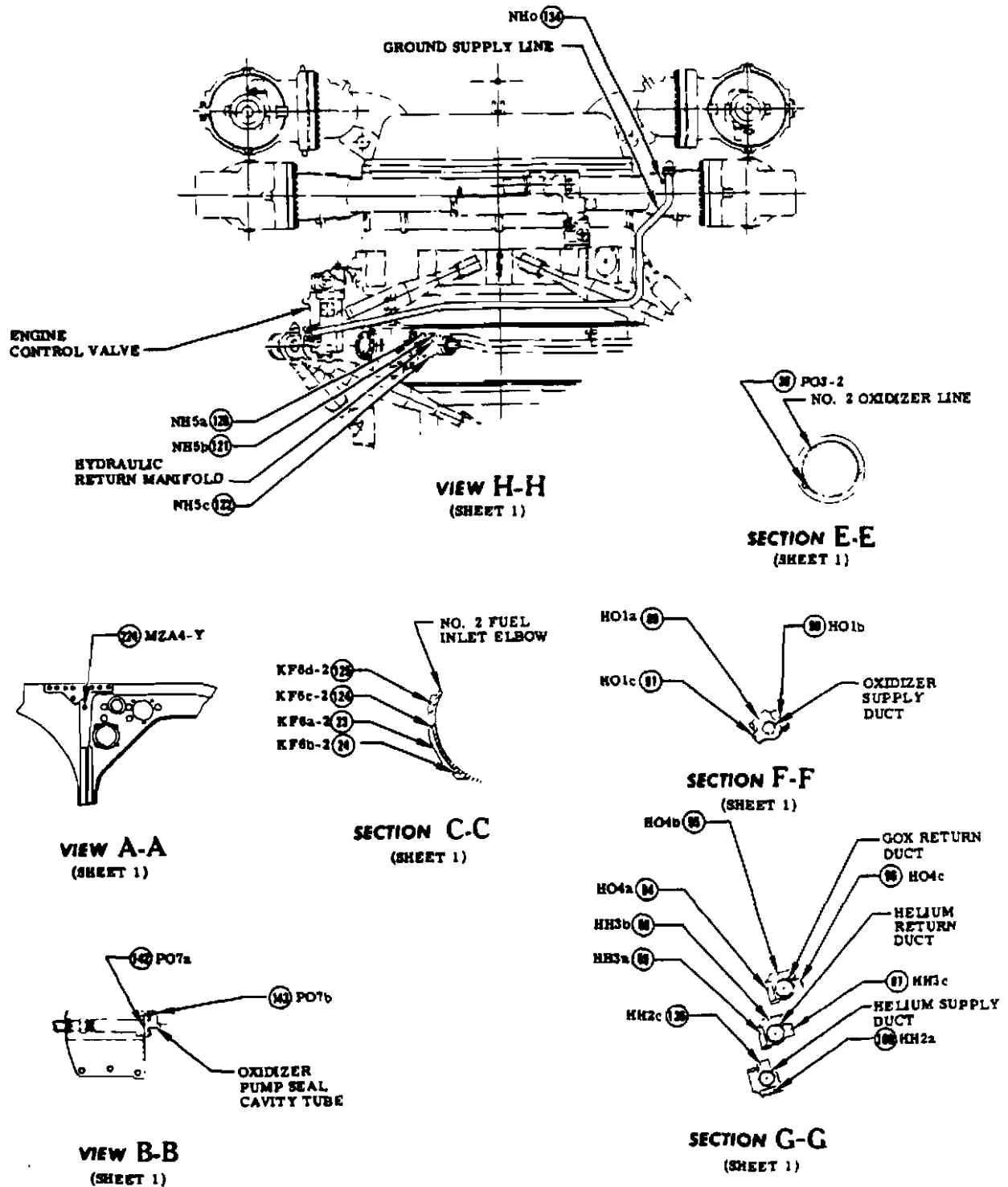

Figure 2-24. Instrumentation Tap Locations (Sheet 3 of 8)



F1-1-4A

Figure 2-24. Instrumentation Tap Locations (Sheet 4 of 8)

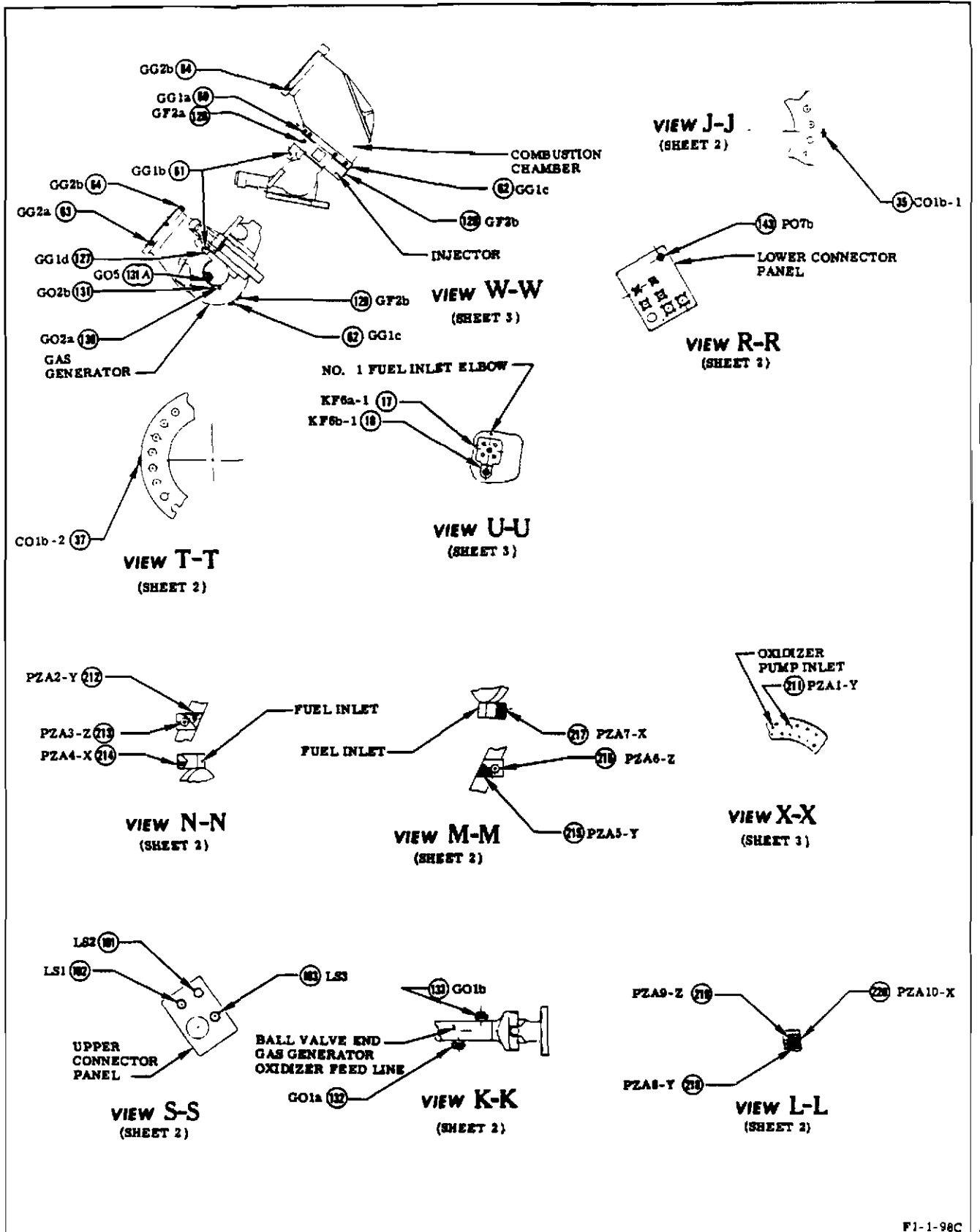

Figure 2-24. Instrumentation Tap Locations (Sheet 5 of 8)

| Item No. | Tap No. | Description | Type | Item No. | Tap No. | Description | Type |
|----------|---------|-------------------------------|------------|----------|---------|--------------------------------|------------|
| 5(a) | PF2a-1 | Fuel pump discharge No. 1 | Flange | 38 | CG1a | Combustion chamber | RP260-1001 |
| 6(e) | PF2b-1 | Fuel pump discharge No. 1 | AND10050-4 | 39(e) | CG1b | Combustion chamber | RP260-1001 |
| 7 | PF2a-2 | Fuel pump discharge No. 2 | Flange | 40(c) | CG1c | Combustion chamber | RP260-1001 |
| 8 | PF2b-2 | Fuel pump discharge No. 2 | AND10050-4 | 41(e) | CG1d | Combustion chamber | RP260-1001 |
| 9 | PF3a-1 | No. 1 fuel valve inlet | RP260-1001 | 46 | GF1 | Gas generator fuel valve inlet | RP260-1001 |
| 11 | PF3a-2 | No. 2 fuel valve inlet | AND10050-4 | 50 | TG4a | Turbine inlet (manifold) | Flange |
| 13 | CF1a | Fuel manifold | RP260-1001 | 51 | TG4b | Turbine inlet (manifold) | RP260-1001 |
| 14(b) | CF1b | Fuel manifold | RP260-1001 | 52 | TG5a | Turbine outlet | RP260-1001 |
| 15 | CF1c | Fuel manifold | RP260-1001 | 53 | TG5b | Turbine outlet | RP260-1001 |
| 16 | CF1d | Fuel manifold | Flange | 60(b) | GG1a | Gas generator chamber | RP260-1001 |
| 17 | KF6a-1 | Fuel pump inlet No. 1 | Flange | 61 | GG1b | Gas generator chamber | AND10050-4 |
| 18 | KF6b-1 | Fuel pump inlet No. 1 | RP260-1001 | 62 | GG1c | Gas generator chamber | RP260-1001 |
| 19 | CF2a | Fuel injection | RP260-1001 | 63 | GG2a | Turbine inlet | RP260-1001 |
| 20(b) | CF2b | Fuel injection | RP260-1001 | 64(f) | GG2b | Turbine inlet | RP260-1001 |
| 21 | CF2c | Fuel injection | RP260-1001 | 65 | PF9 | Fuel seal cavity | MS33656-5 |
| 22 | CF2d | Fuel injection | Flange | 66 | PF10 | Fuel impeller back casing | MS33656-5 |
| 23(a) | KF6a-2 | Fuel pump inlet No. 2 | Flange | 77(b) | NH4 | Engine control system return | RP260-1001 |
| 24(d) | KF6b-2 | Fuel pump inlet No. 2 | RP260-1001 | 80(b) | NH7 | Ignition monitor valve outlet | AND10050-4 |
| 25 | PO2a-1 | Oxidizer pump discharge No. 1 | Flange | 81 | IF2 | Fuel igniter valve inlet | AND10050-4 |
| 26 | PO2b-1 | Oxidizer pump discharge No. 1 | AND10050-4 | 82 | IF3 | Hypergol container inlet | RP260-1001 |
| 27 | PO2a-2 | Oxidizer pump discharge No. 2 | Flange | 85(a) | HH3a | Heat exchanger helium outlet | Flange |
| 28(e) | PO2b-2 | Oxidizer pump discharge No. 2 | AND10050-4 | 86(a) | HH3b | Heat exchanger helium outlet | Flange |
| 29 | PO3-1 | No. 1 oxidizer valve inlet | RP260-1001 | 87 | HH3c | Heat exchanger helium outlet | RP260-1001 |
| 30 | PO3-2 | No. 2 oxidizer valve inlet | RP260-1001 | 88 | HH4 | Heat exchanger helium outlet | RP260-1001 |
| 31 | CO3j | Oxidizer injection | AND10050-4 | 89(a) | HO1a | Heat exchanger oxidizer inlet | Flange |
| 32(b) | CO3b | Oxidizer injection | AND10050-4 | 90(a) | HO1b | Heat exchanger oxidizer inlet | Flange |
| 33 | CO3c | Oxidizer injection | AND10050-4 | | | | |
| 35 | CO1b-1 | Oxidizer dome inlet No. 1 | RP260-1001 | | | | |
| 37 | CO1b-2 | Oxidizer dome inlet No. 2 | RP260-1001 | | | | |

(a) Engines not incorporating MD96 or MD97 change
(b) Engines not incorporating MD140 change
(c) Engines not incorporating MD177 change
(d) Engines not incorporating MD146 change
(e) Engines not incorporating MD141 change
(f) Engines not incorporating MD176 change

Figure 2-24. Instrumentation Tap Locations (Sheet 6 of 8)

| Item No. | Tap No. | Description | Type | Item No. | Tap No. | Description | Type |
|--------------------|---------|-------------------------------|------------|--------------------|---------|----------------------------------|------------|
| 91 | HO1c | Heat exchanger oxidizer inlet | RP260-1001 | 124 ^(a) | KF6c-2 | Fuel pump inlet No. 2 | Flange |
| 92 | HO2 | Heat exchanger oxidizer inlet | RP260-1001 | 125 | KF6d-2 | Fuel pump inlet No. 2 | RP260-1001 |
| 93 | HO3 | Heat exchanger GOX outlet | RP260-1001 | 126 ^(d) | KF7a-2 | Fuel pump inlet No. 2 | RP260-1001 |
| 94 ^(a) | HO4a | Heat exchanger GOX outlet | Flange | 127 | GG1d | Gas generator chamber | Flange |
| 95 ^(a) | HO4b | Heat exchanger GOX outlet | Flange | 128 | GF2a | Gas generator fuel injection | RP260-1001 |
| 96 | HO4c | Heat exchanger GOX outlet | RP260-1001 | 129 | GF2b | Gas generator fuel injection | RP260-1001 |
| 101 | LS1 | Bearing No. 1 | MS33682-5 | 130 | GO2a | Gas generator oxidizer injection | RP260-1001 |
| 102 | LS2 | Bearing No. 2 | MS33682-2 | 131 ^(b) | GO2b | Gas generator oxidizer injection | RP260-1001 |
| 103 | LS3 | Turbine bearing | MS33682-3 | 131A | GO5 | Gas generator oxidizer inlet | RP260-1001 |
| 104 ^(b) | CO2c | Oxidizer manifold | AND10050-4 | 132 | GO1a | Gas generator valve inlet | RP260-1001 |
| 105 | CO3h | Oxidizer injection | AND10050-4 | 133 | GO1b | Gas generator valve inlet | RP260-1001 |
| 106 ^(b) | CO3k | Oxidizer injection | AND10050-4 | 134 | NHO | Ground hydraulic supply | RP260-1001 |
| 107 ^(b) | CO3m | Oxidizer injection | AND10050-4 | 135 ^(b) | HO5 | Heat exchanger GOX outlet | RP260-1001 |
| 108 | CG1e | Combustion chamber | Flange | 136 | HH2c | Heat exchanger helium inlet | RP260-1001 |
| 109 ^(a) | HH2a | Heat exchanger helium inlet | Flange | 137 | LB1a | Oxidizer pump bearing jet | Flange |
| 111 | TG5c | Turbine outlet | Flange | 138 | LB1b | Oxidizer pump bearing jet | RP260-1001 |
| 112 ^(d) | PF2c-1 | Fuel pump discharge No. 1 | RP260-1001 | 139 ^(d) | PO2c-1 | Oxidizer pump discharge No. 1 | RP260-1001 |
| 113 | PF2d-1 | Fuel pump discharge No. 1 | RP260-1001 | 140 | PO2d-1 | Oxidizer pump discharge No. 1 | RP260-1001 |
| 114 | PF2c-2 | Fuel pump discharge No. 2 | RP260-1001 | 141 | PO2c-2 | Oxidizer pump discharge No. 2 | RP260-1001 |
| 116 ^(a) | NH2a | Engine control closing | Flange | 142 ^(a) | PO7a | Oxidizer pump seal cavity | Flange |
| 117 ^(e) | NH2b | Engine control closing | RP260-1001 | 143 | PO7b | Oxidizer pump seal cavity | RP260-1001 |
| 118 ^(a) | NH3a | Engine control opening | Flange | 144 | NH1a | Control system supply | AND10050-4 |
| 119 ^(e) | NH3b | Engine control opening | RP260-1001 | 145 | NH1b | Control system supply | AND10050-4 |
| 120 ^(c) | NH5a | Common hydraulic return | RP260-1001 | 146 | NH8 | Control system override | AND10050-4 |
| 121 | NH5b | Common hydraulic return | RP260-1001 | | | | |
| 122 | NH5c | Common hydraulic return | Flange | | | | |
| 123 | KF7a-1 | Fuel pump inlet No. 1 | RP260-1001 | | | | |

(a) Engines not incorporating MD96 or MD97 change

(b) Engines not incorporating MD140 change

(c) Engines not incorporating MD177 change

(d) Engines not incorporating MD146 change

(e) Engines not incorporating MD141 change

Figure 2-24. Instrumentation Tap Locations (Sheet 7 of 8)

| Item No. | Tap No. | Accelerometer Measurement Description | Direction of Sensitivity (Axis) | Item No. | Tap No. | Accelerometer Measurement Description | Direction of Sensitivity (Axis) |
|----------|---------|---------------------------------------|---------------------------------|----------|---------|---------------------------------------|---------------------------------|
| 201 | CZA1-Y | Oxidizer dome position 1 | Y | 216 | PZA6-Z | Elbow to inlet flange fuel pump No. 2 | Z |
| 202 | CZA2-Y | Oxidizer dome position 2 | Y | 217 | PZA7-X | Elbow to inlet flange fuel pump No. 2 | X |
| 203 | CZA3-Y | Oxidizer dome position 3 | Y | 218 | PZA8-Y | Boss of fuel pump housing | Y |
| 204 | CZA4-Y | Oxidizer dome position 4 | Y | 219 | PZA9-Z | Boss of fuel pump housing | Z |
| 205 | CZA5-Y | Oxidizer dome position 5 | Y | 220 | PZA10-Y | Boss of fuel pump housing | X |
| 206 | CZA6-Y | Oxidizer dome position 6 | Y | 221 | MZA1-X | Interface panel support No. 1 side | Y |
| 207 | CZA7-X | Oxidizer dome position 7 | X | 222 | MZA2-Z | Interface panel support No. 1 side | Z |
| 208 | CZA8-Y | Oxidizer dome position 8 | Y | 223 | MZA3-X | Interface panel support No. 1 side | X |
| 209 | CZA9-Y | Oxidizer dome position 9 | Y | 225 | MZA5-Z | Interface panel support No. 2 side | Z |
| 210 | CZA10-Y | Oxidizer dome position 10 | Y | | | | |
| 211 | PZA1-Y | Oxidizer pump inlet flange | Y | | | | |
| 212 | PZA2-Y | Elbow to inlet flange fuel pump No. 1 | Y | | | | |
| 213 | PZA3-Z | Elbow to inlet flange fuel pump No. 1 | Z | | | | |
| 214 | PZA4-X | Elbow to inlet flange fuel pump No. 1 | X | | | | |
| 215 | PZA5-Y | Elbow to inlet flange fuel pump No. 2 | Y | | | | |

Figure 2-24. Instrumentation Tap Locations (Sheet 8 of 8)

2-50. JOINT AND SEAL DATA.

2-51. SEAL DESCRIPTION.

2-52. Eight types of seals are used in the engine systems. Typical use of the more uncommon seals are shown in figure 2-25. The following paragraphs describe the various types of seals and their applications.

2-53. **NAFLEX SEALS.** The Naflex seal (see figure 2-25) is a pressure-actuated, U-shaped seal with the slot opening radially inward. The legs of the U act as springs to preload the seal leg tip at the flange. The leg tip is covered with a thin teflon film for cryogenic applications or a soft copper or silver plating for

high-temperature applications. The film or plating deforms plastically at ambient temperatures to conform to flange surface irregularities. Loading of the seal tips by the spring legs effects a seal at low pressures and also compensates for flange separation due to increased pressure and differences in material shrinkage caused by temperature changes. On double Naflex seals, the heel of the seal is also teflon-film-coated or copper- or silver-plated. The cavities on either side of the heel, formed by the two seals, are connected by small diameter holes. The cavities are then ducted through the flange area to provide leakage monitoring capability for the seal.

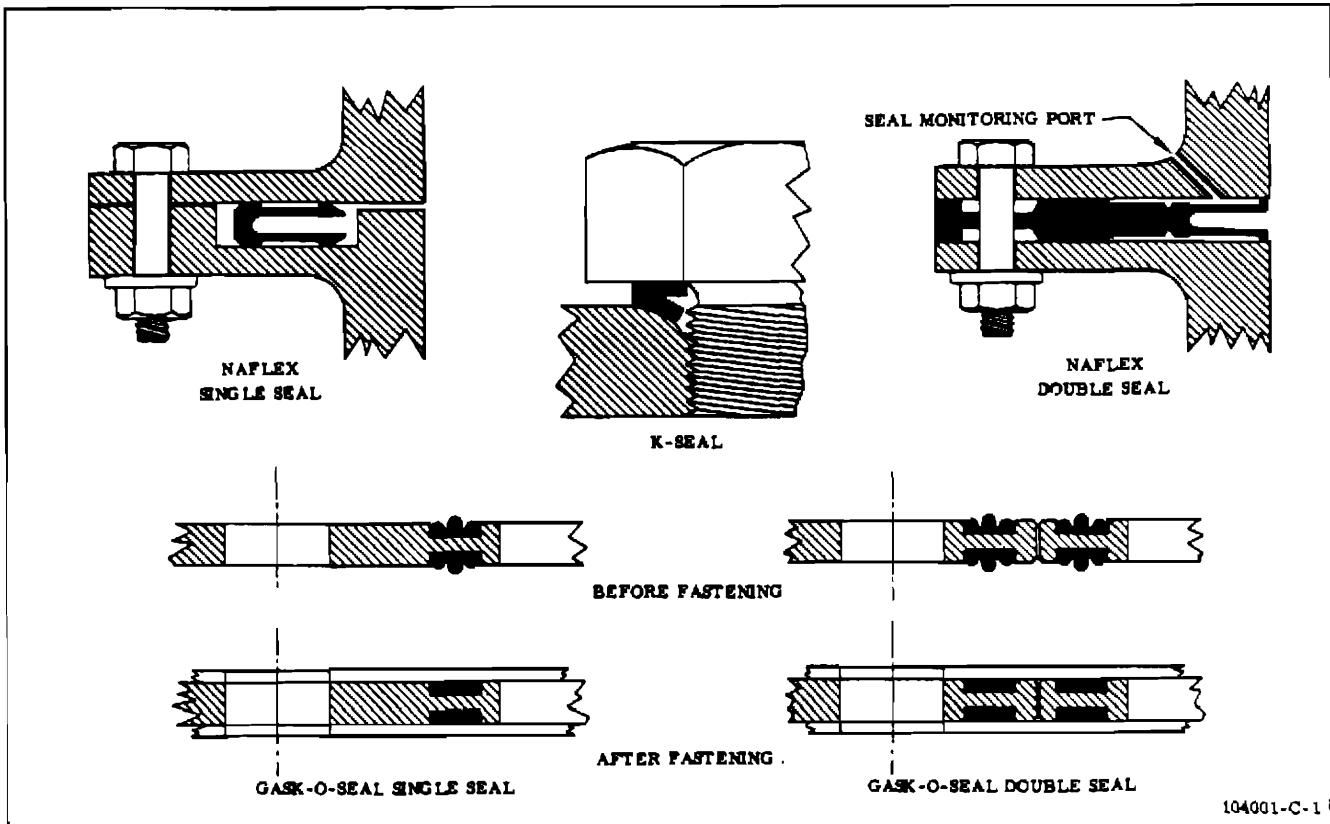

Figure 2-25. Seal Application (Typical)

2-54. **GASK-O-SEALS.** The gask-o-seal (see figure 2-25) is a metal plate with a rubber seal molded into a groove in the plate. Sealing is accomplished by initial compression of the rubber between mating flanges and extrusion of the rubber by the pressurized fluid. The double gask-o-seal consists of a metal plate with rubber seals molded into two grooves in the plate. The cavities on either side of the plate, formed by the two rubber seals, are connected by small diameter holes. The cavities are then ducted through the flange area to provide leakage monitoring capability of the seal.

2-55. **K-SEALS.** The K-seal (see figure 2-25) is a metal seal coated with teflon for cryogenic applications and silver or gold plating for high-temperature applications. This seal is used only on small threaded joints where flange separation will not take place since the leg movement of the K-seal is limited.

2-56. **O-RING SEALS.** The O-ring seal is an elastomeric rubber seal used for static and

dynamic joints in fuel and hydraulic applications. The seal material is Buna N except where the seal will be exposed to trichloroethylene; then the material is Viton A. Sealing is effected by compressing the seal between mating parts on installation; the pressurized fluid also extrudes the seal against the mating parts.

2-57. **ASBESTOS SEALS.** Two types of asbestos seals are used for hot-gas applications at the nozzle extension joint. The thermocore seal, consisting of two wrappings of 1/8-inch asbestos rope, is installed in the nozzle extension flange and depends on a high uniform flange preload to provide a good seal. On engines incorporating MD135 change, an asbestos gasket (tadpole) seal replaces the thermocore seal because of its greater resiliency. This seal consists of two wire-mesh rings covered with asbestos cloth. During nozzle extension installation, the large ring is compressed in the flange groove, and the small ring between the mating flanges.

2-58. **COPPER CRUSH SEALS.** The copper crush seal is a soft-metal-type washer. Joints using this type of seal have machined sharp circumferential ridges to obtain increased unit loading of the seal. Sealing is achieved by pre-loading the seal between two flanges. This type of seal is used for high-temperature applications.

2-59. **FLARED SEALS.** The flared seal consists of a machined, female, flared fitting welded to a tube end, a coupling nut on the tube, and a mating male connector. The coupling nut mates with an external shoulder on the flared fitting. Sealing is achieved between the nose of the male connector and the machined flare as the connector nut is tightened on the male connector.

2-60. **SPIRAL-WOUND GASKETS AND METAL O-RINGS.** The spiral-wound (spirallic) gasket consists of a spirally wound steel ribbon, of chevron cross-sectional shape, with copper or teflon filler between turns. The seal is used in the thrust chamber oxidizer dome-to-injector joint. The metal O-ring seal is used in the thrust chamber body-to-injector joint and provides a seal between fuel and hot gas.

2-61. **JOINT AND SEAL IDENTIFICATION.**

2-62. The locations of system joints are shown in figures 2-26 and 2-27. (Refer to R-3896-3 for removal and installation torque values and R-3896-4 when ordering seals.) The schematics are zoned and each joint is assigned a code number to aid in identification and cross-reference between each schematic and its legend. The code designation identifies the type of fluid used at a specific joint, location of the joint, and if the joint seal leakage can be monitored. Fluid identifications are as follows: O, oxidizer; F, fuel; HF, hydraulic fuel; HG, hot gas; H, helium; and N, nitrogen. For joint location, D designates drain joints. Leakage monitoring ports are indicated by an M. The seal type and material codes used in the legends are as follows:

Type Identification

| <u>Type</u> | <u>Code</u> |
|-----------------|-------------|
| Crush seal | CR |
| Flared fitting | F |
| Gask-o-seal | GO |
| K-seal | KB |
| Naflex seal | NA |
| O-ring seal | OR |
| Spirallic seal | SP |
| Thermocore seal | T |
| Tadpole seal | TP |

Material Identification

| <u>Material</u> | <u>Code</u> |
|-------------------------------|-------------|
| Aluminum | AL |
| Asbestos | A |
| Asbestos - rubber | AR |
| Asbestos - inconel | AI |
| Buna N | BN |
| Copper | C |
| Copper-plated nickel base | CN |
| Silver-plated nickel base | SN |
| Stainless steel | S |
| Copper-plated stainless steel | CS |
| Gold-plated stainless steel | GS |
| Silver-plated stainless steel | SS |
| Teflon-fill stainless steel | STF |
| Teflon-coated steel | TS |
| Viton A | VA |

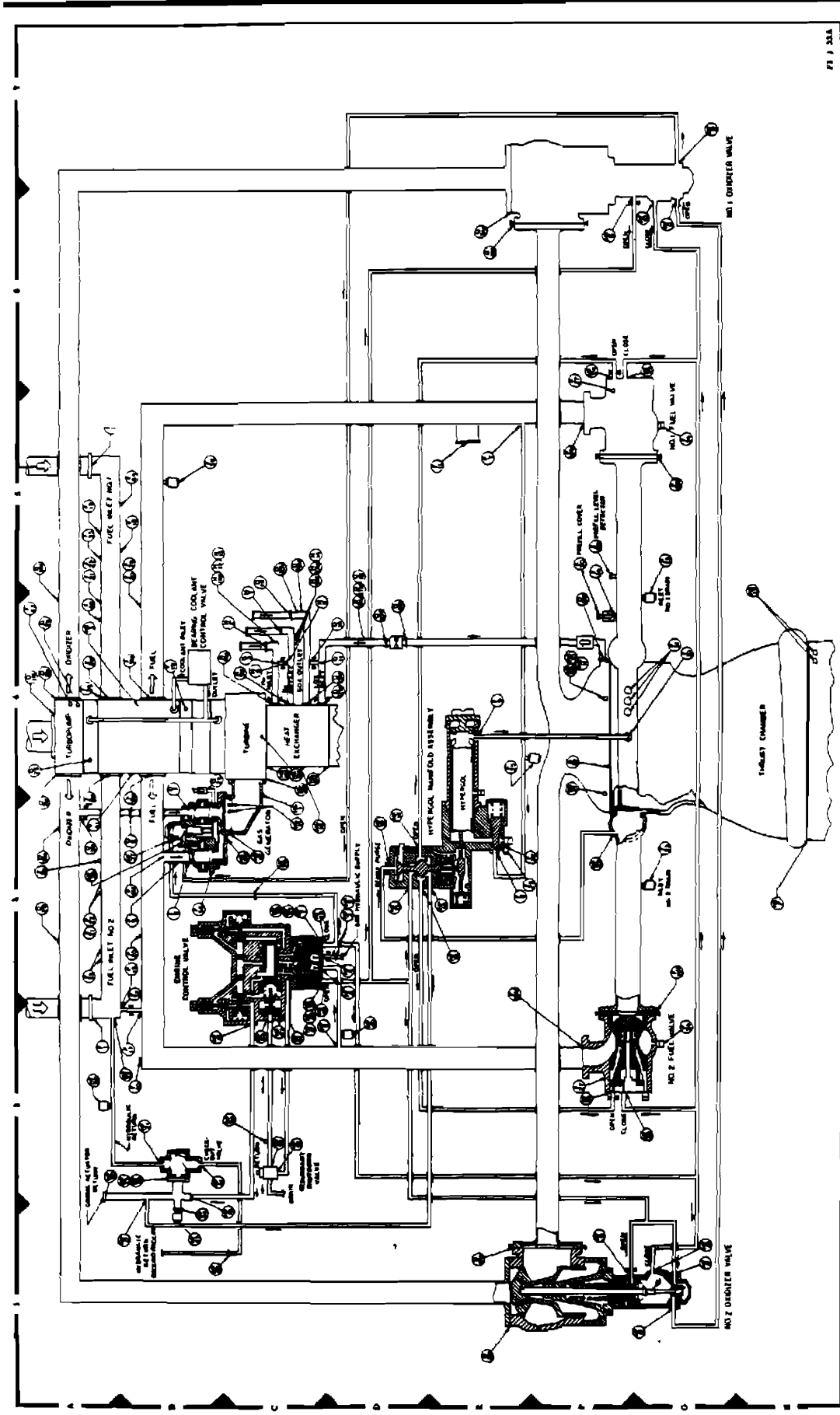

PI 3 31A

Figure 2-26. System Joint and Seal Schematic (Sheet 1 of 15)
Change No. 9 - 4 November 1970 2-57

| Joint Information | | | Seal Information | | | Environment | | Number of Fasteners |
|--|-------|---|------------------|----------|---------|----------------|----------------|---------------------|
| Zone | Code | Description | Type | Material | ID, in. | Pressure, psig | Temperature °F | |
| OXIDIZER PROPELLANT SYSTEM JOINTS | | | | | | | | |
| A4 | 0-1M | LOX Suction Duct to LOX Pump | NA | TS | 17.026 | 115 | -300 | 36 |
| A4 | 0-2M | No. 1 and 2 LOX Pump Discharge to Spacer to LOX High-Pressure Ducts (4 seals) | NA | TS | 9.00 | 1,700 | -300 | 24 |
| E1 E6 | 0-3M | No. 1 and 2 LOX High-Pressure Duct to Spacer to MLV Inlet (4 seals) | NA | TS | 9.00 | 1,700 | -300 | 24 |
| E1 E6 | 0-4M | No. 1 and 2 MLV to LOX Dome Inlets (2 seals) | NA | TS | 9.00 | 1,500 | -300 | 24 |
| A3 | 0-5M | No. 2 LOX High-Pressure Duct to B/S Line (2 seals) | NA | TS | 1.924 | 1,200 | -300 | 8 |
| B3 | 0-6 | B/S Line to GG LOX Supply Line (3 different seals) | NA | TS | 2.486 | 1,200 | -300 | 8 |
| B3 | 0-7 | GG LOX Supply Line to GG Ball Valve | NA | TS | 2.111 | 1,200 | -300 | 8 |
| F5 | 0-8M | H. E. LOX Check Valve to LOX Dome | NA | TS | 2.486 | 1,200 | -300 | 8 |
| D5 | 0-9M | H. E. LOX Check Valve to H. E. LOX Flowmeter | NA | TS | 2.00 | 1,450 | -300 | 8 |
| D5 | 0-10M | H. E. LOX Flowmeter to H. E. LOX Inlet Line | NA | TS | 1.635 | 1,400 | -300 | 8 |
| C4 | 0-11 | H. E. LOX Bypass Line to H. E. LOX Inlet Line (2 seals) | NA | TS | 1.635 | 1,350 | -300 | 8 |
| C4 | 0-12M | H. E. LOX Inlet Line to H. E. | NA | TS | 1.026 | 1,300 | -300 | 4 |
| C4 | 0-13M | H. E. GOX Outlet Line to H. E. | NA | CN | 3.735 | 1,300 | -300 | 8 |
| C4 | 0-13M | H. E. GOX Outlet Line to H. E. | NA | CN | 3.780 | 1,300 | 800 | 8 |

Figure 2-26. System Joint and Seal Schematic (Sheet 2 of 13)

| Joint Information | | | Seal Information | | | Environment | | Number of Fasteners |
|--|-------|--|------------------|----------|----------------|----------------|-----------------|---------------------|
| Zone | Code | Description | Type | Material | ID, in. | Pressure, psig | Temperature, °F | |
| <u>OXIDIZER PROPELLANT SYSTEM JOINTS (continued)</u> | | | | | | | | |
| C4 | 0-14 | H. E. LOX Bypass Line to H. E. GOX Outlet Line | NA | TS | 1.032 | 1,300 | 0 | 4 |
| C4 | 0-15 | H. E. GOX Outlet Line to H. E. GOX Wrap-Around Line | NA | SN | 1.530 | 1,300 | 800 | 8 |
| D5 | 0-16M | H. E. LOX Inlet Pressure Transducer (a) | NA | TS | 0.510 | 1,300 | -300 | 4 |
| D5 | 0-17M | H. E. LOX Inlet Temperature Transducer(a) | NA | TS | 0.510 | 1,300 | -300 | 4 |
| D5 | 0-18 | Tube (H. E. LOX Inlet Pressure)(a) | NA | TS | 0.510 | 1,300 | -300 | 4 |
| C4 | 0-19M | H. E. GOX Out Pressure Transducer and Hose (2 seals) | NA | CN | 0.510 | 1,300 | 800 | 4 |
| C4 | 0-20M | H. E. GOX Out Temperature Transducer(a) | NA | CN | 0.510 | 1,300 | 800 | 4 |
| A3 A4 | 0-21M | LOX Pump Discharge Pressure Transducer and Tube Assembly (4 seals) | NA | TS | 0.510 | 1,700 | -300 | 4 |
| B4 | 0-23 | GG LOX Purge Check Valve to GG Ball Valve | NA | TS | 0.464 | 1,200 | -300 | 3 |
| A4 | 0-25 | LOX Seal Cavity Pressure Transducer(a) | NA | TS | 0.510 | 12 | -300 to +130 | 4 |
| A4 | 0-26 | LOX Pump Seal Cavity; Static Firing Instrumentation (Port PO2b-2)(4 seals) | F | AL | 0.213 | 1,700 | -300 | 1 |
| A3 A4 | 0-28 | LOX Pump Discharge No. 2; Static Firing Instrumentation (Port PO2b-2)(2 seals each of 2 different seals) | KB F | TS AL | 0.451 0.213 | 1,700 1,700 | -300 -300 | 1 1 |

(a) Engines not incorporating MD96 or MD97 change

Figure 2-26. System Joint and Seal Schematic (Sheet 3 of 13)

| Joint Information | | | Seal Information | | | Environment | | Number of Fasteners |
|--|------|--|------------------|----------|---------|----------------|----------------|---------------------|
| Zone | Code | Description | Type | Material | ID, in. | Pressure, psig | Temperature, F | |
| <u>OXIDIZER PROPELLANT SYSTEM JOINTS (continued)</u> | | | | | | | | |
| A5 (continued) | 0-29 | LOX Pump Discharge No. 1; Static Firing Instrumentation (Port PO2b-1)(2 seals each of 2 different seals) | KB | TS | 0.451 | 1,700 | -300 | 1 |
| | | | F | AL | 0.213 | 1,700 | -300 | 1 |
| F3 | 0-30 | Oxidizer Dome to Injector | SP | STF | 41.062 | 1,450 | -300 | 58 |
| <u>FUEL PROPELLANT SYSTEM JOINTS</u> | | | | | | | | |
| A2 A5 | F-1 | Fuel Suction Duct to Fuel Low-Pressure Duct (2 seals) | GO | VA | 12 | 150 | 0-130 | 40 |
| A4 | F-2M | Fuel Low-Pressure Duct to Fuel Pump Inlet (2 seals) | GO | VA | 8.5 | 150 | 0-130 | 36 |
| B4 | F-3M | No. 1 and 2 Fuel Pump Outlet to Spacer to High-Pressure Ducts (4 seals) | GO | VA | 6 | 1,815 | 0-130 | 20 |
| B3 | F-4M | No. 2 Fuel High-Pressure Duct to GG Fuel Upstream Line | GO | VA | 2.28 | 1,815 | 0-130 | 8 |
| E B3 | F-5 | GG Fuel Upstream Line to GG Fuel Downstream Line | GO | VA | 1.25 | 1,815 | 0-130 | 8 |
| B3 | F-6 | GG Fuel Downstream Line to GG Ball Valve Inlet | GO | VA | 2 | 1,330 | 0-130 | 8 |
| E5 | F-7 | No. 1 Fuel High-Pressure Duct to Igniter Fuel Valve Supply Line | GO | VA | 0.875 | 1,815 | 0-130 | 4 |
| | | No. 1 Fuel High-Pressure Duct to Igniter Fuel Valve Supply | OR | VA | 1.176 | 1,815 | 0-130 | 4 |
| E3 | F-8 | Igniter Fuel Valve Supply Line to Igniter Fuel Valve Inlet | GO | VA | 0.625 | 1,700 | 0-130 | 4 |
| | | Igniter Fuel Valve Supply Line to Igniter Fuel Valve Inlet (2 seals) | OR | VA | 1.176 | 1,700 | 0-130 | 4 |

Figure 2-26. System Joint and Seal Schematic (Sheet 4 of 13)

| Joint Information | | | Seal Information | | | Environment | | Number of Fasteners |
|--|---------|--|------------------|----------|---------|----------------|-----------------|---------------------|
| Zone | Code | Description | Type | Material | ID, in. | Pressure, psig | Temperature, °F | |
| FUEL PROPELLANT SYSTEM JOINTS (continued) | | | | | | | | |
| E4 | F-9 | Igniter Fuel Valve to Igniter Fuel Line | GO | VA | 0.625 | 1,500 | 0-130 | 4 |
| F4 | F-10 | Igniter Fuel Line to Thrust Chamber Injector | GO | VA | 0.625 | 1,400 | 0-130 | 4 |
| E5 | F-11 | No. 1 High-Pressure Duct to Gimbal Supply Cover | GO | VA | 3 | 1,815 | 0-130 | 8 |
| F2 | F-12M | Fuel High-Pressure Duct to No. 1 and 2 MFV (2 seals) | GO | VA | 6.52 | 1,815 | 0-130 | 20 |
| F5 | | Fuel High-Pressure Duct to Spacer to No. 1 and 2 MFV (4 seals) | GO | VA | 6.52 | 1,815 | 0-130 | 20 |
| G2 | F-13M | No. 1 and 2 MFV to Fuel Manifold Inlet (2 seals) | GO | VA | 3 | 1,520 | 0-130 | 20 |
| F4 | F-14 | Prefill Inlet Boss (cover) | GO | VA | 1.492 | 1,520 | 0-130 | 6 |
| F5 | F-15M | Prefill Level Detector Boss | GO | VA | 1.499 | 1,520 | 0-130 | 6 |
| B2 | F-16 | High-Pressure Duct Bleed Line to Low-Pressure Duct | GO | VA | 0.57 | 1,800 | 0-130 | 4 |
| B2 | F-17 | High-Pressure Duct Bleed Line to High-Pressure Duct | GO | VA | 0.735 | 1,800 | 0-130 | 4 |
| A5 | F-18(a) | Fuel Pump Inlet Temperature Transducer | GO | VA | 0.735 | 150 | 0-130 | 4 |
| B4 | F-19 | Bearing Jet Pressure Transducer | GO | VA | 0.735 | 400 | 0-130 | 4 |
| B3 | F-20 | Fuel Pump Discharge Pressure Transducer (4 seals) | GO | VA | 0.735 | 1,815 | 0-130 | 4 |
| A3 | F-21 | Fuel Pump Inlet Pressure Transducer (2 seals) | GO | VA | 0.735 | 150 | 0-130 | 4 |
| A4 | F-22 | Fuel Pump Inlet Pressure Adapter to Inlet (2 seals) | GO | VA | 0.735 | 150 | 0-130 | 4 |
| G3 | F-23 | Fuel Inlet Manifold Disconnect (2 seals) | OR | VA | 1.045 | 1,520 | 0-130 | 4 |

(a) Engines not incorporating MD96 or MD97 change

Figure 2-26. System Joint and Seal Schematic (Sheet 5 of 13)

| Joint Information | | | Seal Information | | | Environment | | Number of Fasteners |
|--|------|--|------------------|----------|---------|----------------|-----------------|---------------------|
| Zone | Code | Description | Type | Material | ID, in. | Pressure, psig | Temperature, °F | |
| FUEL PROPELLANT SYSTEM JOINTS (continued) | | | | | | | | |
| G2 | F-24 | Fuel Valve Drain Port | OR | VA | 0.468 | 1,520 | 0-130 | 1 |
| G5 | | Disconnect (2 seals) | | | | | | |
| E4 | F-25 | Igniter Fuel Supply Line Disconnect | OR | VA | 0.739 | 1,815 | 0-130 | 4 |
| B5 | F-26 | Fuel Impeller Back-casing Supply Orifice | GO | VA | 1.125 | 1,815 | 0-130 | 4 |
| F2 | F-27 | Fuel Valve Disconnect (2 seals) | OR | VA | 0.739 | 1,815 | 0-130 | 4 |
| E3 | F-28 | Adapter, Hypergol Bleed | GO | VA | 0.401 | 1,700 | 0-130 | 4 |
| E3 | F-29 | Adapter Plug, Hypergol Bleed | OR | VA | 0.351 | 1,700 | 0-130 | 1 |
| F3 | F-30 | Prefill Inlet Valve Assembly | OR | VA | 0.75 | 1,520 | 0-130 | 6 |
| F4 | F-31 | Calip Switch Boss to Calip Switch | GO | VA | 0.735 | 1,520 | 0-130 | 6 |
| B2 | F-32 | High-Pressure Duct Bleed Line to Low-Pressure Duct | GO | VA | 0.735 | 1,815 | 0-130 | 4 |
| A3 | F-33 | AN814-4C Plug; Fuel Pump Inlet (3 seals) | OR | VA | 0.351 | 150 | 0-130 | 1 |
| A5 | | | | | | | | |
| B4 | F-34 | Fuel Inlet Duct to Pump; Seal Monitoring Port (2 seals) | OR | VA | 0.239 | 150 | 0-130 | 1 |
| B5 | F-35 | Fuel High-Pressure Duct; Disconnect | OR | VA | 0.739 | 1,815 | 0-130 | 4 |
| B3 | F-36 | Gas Generator Fuel Drain Disconnect (2 different seals) | OR | VA | 0.468 | 1,300 | 0-130 | 1 |
| | F-38 | Fuel Pump Inlet No. 2; Static Firing Instrumentation (Port KF6d-2)(5 RD and 2 VSF seals) | OR | VA | 0.351 | 150 | 0-130 | 1 |
| | F-40 | No. 2 Fuel Discharge; Static Firing Instrumentation (Port PF2b-2)(2 seals) | F | AL | 0.213 | 150 | 0-130 | 1 |
| B4 | F-41 | Fuel Impeller Back-casing; Static Firing Instrumentation (PF-10)(2 seals) | F | AL | 0.213 | 1,300 | 0-130 | 1 |

Figure 2-26. System Joint and Seal Schematic (Sheet 6 of 13)

| Joint Information | | | Seal Information | | | Environment | | Number of Fasteners |
|--|----------|---|------------------|----------|---------|----------------|-----------------|---------------------|
| Zone | Code | Description | Type | Material | ID, in. | Pressure, psig | Temperature, °F | |
| <u>FUEL PROPELLANT SYSTEM JOINTS (continued)</u> | | | | | | | | |
| A4 | F-43 | Fuel Pump Discharge No. 1; Static Firing Instrumentation (Port PF2b-1)(2 seals each of 2 different seals) | OR | VA | 0.351 | 1,815 | 0-130 | 1 |
| B5 | F-44 | LOX Pump Bearing Jet; Static Firing Instrumentation (Port LD1b)(2 seals) | F | AL | 0.213 | 1,815 | 0-130 | 1 |
| | F-45 | Fuel Pump Inlet No. 1; Static Firing Instrumentation (Port KF6b-1)(2 seals) | F | AL | 0.213 | 150 | 0-130 | 1 |
| <u>HELIUM SYSTEM JOINTS</u> | | | | | | | | |
| C4 | H-1 | Customer Connect to Helium Supply Crossover | NA | TS | 1.250 | 350 | -300 | 6 |
| C4 | H-2 | Helium Crossover to Supply Duct Assembly | NA | TS | 1.250 | 350 | -300 | 6 |
| C4 | H-3 | Helium Supply Duct to Bypass Hose (2 seals) | NA | TS | 1.026 | 350 | -300 | 4 |
| C4 | H-4M | Helium Supply Duct to H. E. | NA | CN | 3.2 | 350 | -300 | 8 |
| C4 | H-5M | H. E. to Helium Return Duct | NA | CN | 3.2 | 250 | 600 | 8 |
| C4 | H-6 | Helium Return Duct to Bypass Hose | NA | TS | 1.032 | 250 | 0 | 4 |
| C4 | H-7 | Helium Return Duct to Crossover | NA | SN | 1.530 | 250 | 600 | 8 |
| C4 | H-8 | Helium Crossover Return to Customer Connect | NA | SN | 1.530 | 250 | 600 | 8 |
| C4 | H-9M(a) | H. E. Helium Outlet Pressure Transducer | NA | CN | 0.510 | 250 | 600 | 4 |
| C4 | H-10M(a) | H. E. Helium Outlet Temperature Transducer | NA | CN | 0.510 | 250 | 600 | 4 |

(a) Engines not incorporating MD96 or MD97 change

Figure 2-26. System Joint and Seal Schematic (Sheet 7 of 13)

| Joint Information | | | Seal Information | | | Environment | | Number of Fasteners |
|---|----------|---|------------------|----------|---------|----------------|-----------------|---------------------|
| Zone | Code | Description | Type | Material | ID, in. | Pressure, psig | Temperature, °F | |
| <u>HELIUM SYSTEM JOINTS (continued)</u> | | | | | | | | |
| C4 | H-11M(a) | H. E. Helium Inlet Pressure Transducer | NA | TS | 0.510 | 350 | -300 | 4 |
| C4 | H-12(a) | H. E. Helium Inlet Temperature Transducer | NA | TS | 0.510 | 350 | -300 | 4 |
| C4 | H-13(a) | 703203 Hose (H. E. Helium Inlet Pressure) | NA | TS | 0.510 | 350 | -300 | 4 |
| C4 | H-14(a) | 703203 Hose (H. E. Helium Outlet Pressure) | NA | CN | 0.510 | 250 | 600 | 4 |
| <u>HYDRAULIC FLUID SYSTEM JOINTS</u> | | | | | | | | |
| D3 | HF-2 | Hydraulic Supply Crossover Cover | GO | VA | 1.31 | 1,800 | 0-130 | 8 |
| D3 | HF-3 | Hydraulic Supply Crossover Line | GO | VA | 0.875 | 1,800 | 0-130 | 8 |
| C4 | HF-4 | Ground Supply Port of Control Valve | GO | VA | 0.875 | 1,800 | 0-130 | 4 |
| D2 | HF-5 | High-Pressure Duct to Control Valve Supply Line (2 seals) | GO | VA | 1.176 | 1,800 | 0-130 | 4 |
| C3 | HF-6 | Engine Supply Port of Control Valve (2 seals) | OR | VA | 1.114 | 1,800 | 0-130 | 4 |
| C3 | HF-7 | Close-Pressure Port of Control Valve (2 seals)(1 seal) | GO | VA | 0.875 | 1,800 | 0-130 | 4 |
| C3 | HF-8 | Open-Pressure Port of Control Valve (2 seals) | GO | VA | 0.875 | 1,800 | 0-130 | 4 |
| F1 F6 | HF-9 | No. 1 and 2 MLV Open Control Port (2 seals) | GO | VA | 0.870 | 1,800 | 0-130 | 4 |
| G1 G6 | HF-10 | No. 1 and 2 MLV Close Control Port (2 seals) | GO | VA | 0.625 | 1,800 | 0-130 | 4 |
| G1 G6 | HF-11 | No. 1 and 2 Main Oxidizer Sequence Valve Inlet (2 seals) | GO | VA | 0.406 | 1,800 | 0-130 | 4 |

(a) Engines not incorporating MD96 or MD97 change

Figure 2-26. System Joint and Seal Schematic (Sheet 8 of 13)

| Joint Information | | | Seal Information | | | Environment | | Number of Fasteners |
|--|-------|---|------------------|----------|---------|----------------|-----------------|---------------------|
| Zone | Code | Description | Type | Material | ID, in. | Pressure, psig | Temperature, °F | |
| HYDRAULIC FLUID SYSTEM JOINTS (continued) | | | | | | | | |
| G1 G7 | HF-12 | No. 1 and 2 Main Oxidizer Sequence Valve Outlet (2 seals) | GO | VA | 0.406 | 1,800 | 0-130 | 4 |
| D3 | HF-13 | IMV Hydraulic Inlet Port | GO | VA | 0.625 | 1,800 | 0-130 | 4 |
| D3 | HF-14 | IMV Open Port to No. 1 MFV | GO | VA | 0.406 | 1,800 | 0-130 | 4 |
| D3 | HF-15 | IMV Open Port to No. 2 MFV | GO | VA | 0.406 | 1,800 | 0-130 | 4 |
| D3 | HF-16 | IMV Hydraulic Return Port | GO | VA | 0.500 | 1,800 | 0-130 | 4 |
| B1 | HF-17 | IMV Return to Common System Return | GO | VA | 0.500 | 1,800 | 0-130 | 4 |
| C2 | HF-18 | Control Valve Hydraulic Return Port | GO | VA | 1.125 | 1,800 | 0-130 | 6 |
| B2 | HF-19 | Control Valve Return Line to Common Return | GO | VA | 1.125 | 1,800 | 0-130 | 6 |
| A2 | HF-20 | Blind Cover 601546 to Common Hydraulic Return | GO | VA | 2.448 | 1,800 | 0-130 | 8 |
| B2 | HF-21 | Engine Hydraulic Return Line at Checkout Valve | GO | VA | 2.750 | 1,800 | 0-130 | 8 |
| A2 | HF-22 | Engine Hydraulic Return Line to No. 2 Fuel Inlet | GO | VA | 2.750 | 1,800 | 0-130 | 8 |
| B2 | HF-23 | Actuator Return Line Assembly to Checkout Valve | GO | VA | 2.750 | 1,800 | 0-130 | 8 |
| F2 F6 | HF-24 | No. 1 and 2 MFV Open Control Port (2 seals) | GO | VA | 0.735 | 1,800 | 0-130 | 8 |
| F2 F6 | HF-25 | No. 1 and 2 MFV Closing Control Port (2 seals) | GO | VA | 0.406 | 1,800 | 0-130 | 4 |
| C3 | HF-26 | Flange in GG Close Line | GO | VA | 0.406 | 1,800 | 0-130 | 4 |
| B3 | HF-27 | Closing Control Line at GG | GO | VA | 0.406 | 1,800 | 0-130 | 4 |
| B3 | HF-28 | Opening Control Line at GG | GO | VA | 0.400 | 1,800 | 0-130 | 6 |
| F3 | HF-29 | IMV Sense Line at Fuel Manifold | GO | VA | 0.307 | 1,800 | 0-130 | 4 |

Figure 2-26. System Joint and Seal Schematic (Sheet 9 of 13)

| Joint Information | | | Seal Information | | | Environment | | Number of Fasteners |
|--|----------|---|------------------|----------|----------------|----------------|-----------------|---------------------|
| Zone | Code | Description | Type | Material | ID, in. | Pressure, psig | Temperature, °F | |
| HYDRAULIC FLUID SYSTEM JOINTS (continued) | | | | | | | | |
| D3 | HF-32 | IMV Sense Pressure Inlet Port (2 seals) | OR | VA | 0.739 | 1,800 | 0-130 | 4 |
| B2 | HF-35 | Common Hydraulic Return Pressure Transducer | GO | VA | 0.735 | 1,800 | 0-130 | 4 |
| C3 | HF-36(a) | Engine Control Open Transducer | GO | VA | 0.735 | 1,800 | 0-130 | 4 |
| C3 | HF-37(a) | Engine Control Close Transducer | GO | VA | 0.735 | 1,800 | 0-130 | 4 |
| C3 | HF-38 | Plugs at Open and Close Control Ports of Control Valve (2 seals) | OR | VA | 0.351 | 1,800 | 0-130 | 1 |
| A2 | HF-39 | Hydraulic Return Disconnect | OR | VA | 0.739 | 1,800 | 0-130 | 4 |
| D2 | HF-40 | Four-Way Valve Supply Disconnect | OR | VA | 0.739 | 1,800 | 0-130 | 4 |
| B2 | HF-41 | Checkout Valve to Hydraulic Return Ground Facility Line | GO | VA | 2.323 | 1,800 | 0-130 | 8 |
| B1 | HF-44 | Gimbal Return Line Cover | GO | VA | 2.448 | 1,800 | 0-130 | 8 |
| B1 | HF-45 | Gimbal Return Line Cover Disconnect | OR | VA | 0.739 | 1,800 | 0-130 | 4 |
| C1 | HF-46 | Hydraulic Return Line to Crossover | GO | VA | 1.52 | 1,800 | 0-130 | 6 |
| C2 | HF-47 | Control System Supply; Static Firing Instrumentation (Port NH1b)(2 seals each of 2 different seals) | OR | VA | 0.351 | 1,800 | 0-130 | 1 |
| C3 | HF-48 | Engine Control Open; Static Firing Instrumentation (Port NH3b) (2 seals) | F OR | AL VA | 0.213 0.351 | 1,800 1,800 | 0-130 0-130 | 1 1 |

(a) Engines not incorporating MD96 or MD97 change

Figure 2-26. System Joint and Seal Schematic (Sheet 10 of 13)

| Joint Information | | | Seal Information | | | Environment | | Number of Fasteners |
|--|-------|---|------------------|----------|---------|----------------|-----------------|---------------------|
| Zone | Code | Description | Type | Material | ID, in. | Pressure, psig | Temperature, °F | |
| <u>HYDRAULIC FLUID SYSTEM JOINTS (continued)</u> | | | | | | | | |
| C3 | HF-49 | Engine Control Close; Static Firing Instrumentation (Port NH2b) (2 seals each of 2 different seals) | OR | VA | 0.351 | 1,800 | 0-130 | 1 |
| C2 | HF-51 | Engine Control Valve to Redundant Shutdown Valve (Port NH1a) | F | AL | 0.213 | 1,800 | 0-130 | 1 |
| C2 | HF-51 | Engine Control Valve to Redundant Shutdown Valve (Port NH1a) | O | VA | 0.351 | 1,800 | 0-130 | 1 |
| C2 | HF-52 | Engine Control Valve to Redundant Shutdown Valve (In Port) | GO | VA | 0.182 | 1,800 | 0-130 | 4 |
| C2 | HF-53 | Redundant Shutdown Valve to Engine Control Valve (Out Port) | GO | VA | 0.182 | 1,800 | 0-130 | 4 |
| C2 | HF-54 | Redundant Shutdown Valve to Engine Control Valve (Override Port) | F | AL | 0.213 | 1,800 | 0-130 | 1 |
| C2 | HF-55 | Redundant Shutdown Valve to Engine Control Valve (Port NH8) (2 seals each of 2 different seals) | O | VA | 0.644 | 1,800 | 0-130 | 1 |
| C2 | HF-55 | Redundant Shutdown Valve to Engine Control Valve (Port NH8) (2 seals each of 2 different seals) | OR | VA | 0.351 | 1,800 | 0-130 | 1 |
| C2 | HF-55 | Redundant Shutdown Valve to Engine Control Valve (Port NH8) (2 seals each of 2 different seals) | F | AL | 0.213 | 1,800 | 0-130 | 1 |
| <u>HOT-GAS SYSTEM JOINTS</u> | | | | | | | | |
| C4 | HG-1 | Gas Generator Compressor Drain Plug | KB | GS | 0.451 | 1,000 | 1,450 | 1 |
| C4 | HG-2M | Gas Generator Compressor to Turbine Inlet | NA | SN | 8.780 | 1,000 | 1,450 | 24 |
| B4 | HG-3 | Turbine Torus Temperature Transducer | NA | SN | 0.510 | 950 | 1,600 | 4 |
| C4 | HG-4M | Turbine to Heat Exchanger | NA | SN | 40.755 | 60 | 1,170 | 120 |
| C4 | HG-5M | Turbine Outlet Pressure Transducer and Hose (2 seals) | NA | SN | 0.510 | 60 | 1,170 | 4 |

Figure 2-26. System Joint and Seal Schematic (Sheet 11 of 13)

| Joint Information | | | Seal Information | | | Environment | | Number of Fasteners |
|--|-------|---|------------------|----------|----------------------------|----------------|-----------------|---------------------|
| Zone | Code | Description | Type | Material | ID, in. | Pressure, psig | Temperature, °F | |
| <u>HOT-GAS SYSTEM JOINTS (continued)</u> | | | | | | | | |
| C4 | HG-6M | Heat Exchanger to Exhaust Manifold | NA | SN | 23.94 | 30 | 1,170 | 60 |
| H3 | HG-7 | Thrust Chamber to Nozzle Extension | TP | AN | (117.1 in length per seal) | 20 | 1,170 | 240 |
| C4 | HG-8M | GG Chamber Pressure Transducer | NA | SN | 0.510 | 1,000 | 140 | 4 |
| F4 | HG-9M | Thrust Chamber Combustion Chamber Pressure Transducer | NA | SN | 0.510 | 1,100 | 500 | 4 |
| F4 | HG-10 | Thrust Chamber Pressure Transducer Boss | NA | CN | 0.875 | 1,100 | 500 | 6 |
| F4 | HG-11 | Thrust Chamber Pressure Adapter Plug | KB | GS | 0.325 | 1,100 | 500 | 1 |
| H4 | HG-13 | Nozzle Extension Igniter (2 seals) | CR | C | 0.682 | 20 | 1,170 | 1 |
| C4 | HG-15 | Gas Generator Igniter (2 seals) | CR | C | 0.682 | 1,000 | 1,450 | 1 |
| C4 | HG-16 | Heat Exchanger; Static Firing Instrumentation (Port TG5A) (2 seals each of 2 different seals) | KB F | TS AL | 0.451 0.213 | 1,000 1,000 | 1,450 1,450 | 1 1 |
| C4 | HG-18 | GG Chamber; Static Firing Instrumentation (Port GG1b) (1 K-seal and 2 VSF seal) | KB F | TS AL | 0.451 0.213 | 1,000 1,000 | 140 140 | 1 1 |

Figure 2-26. System Joint and Seal Schematic (Sheet 12 of 13)

| Joint Information | | | Seal Information | | | Environment | | Number of Fasteners |
|--|-------|---|------------------|----------|---------|----------------|-----------------|---------------------|
| Zone | Code | Description | Type | Material | ID, in. | Pressure, psig | Temperature, °F | |
| <u>HOT-GAS SYSTEM JOINTS (continued)</u> | | | | | | | | |
| F4 | HG-21 | Combustion Chamber; Static Firing Instru- mentation (Port CG1d) (one seal) | KB | TS | 0.451 | 1,000 | 1,450 | 1 |

Figure 2-26. System Joint and Seal Schematic (Sheet 13 of 13)

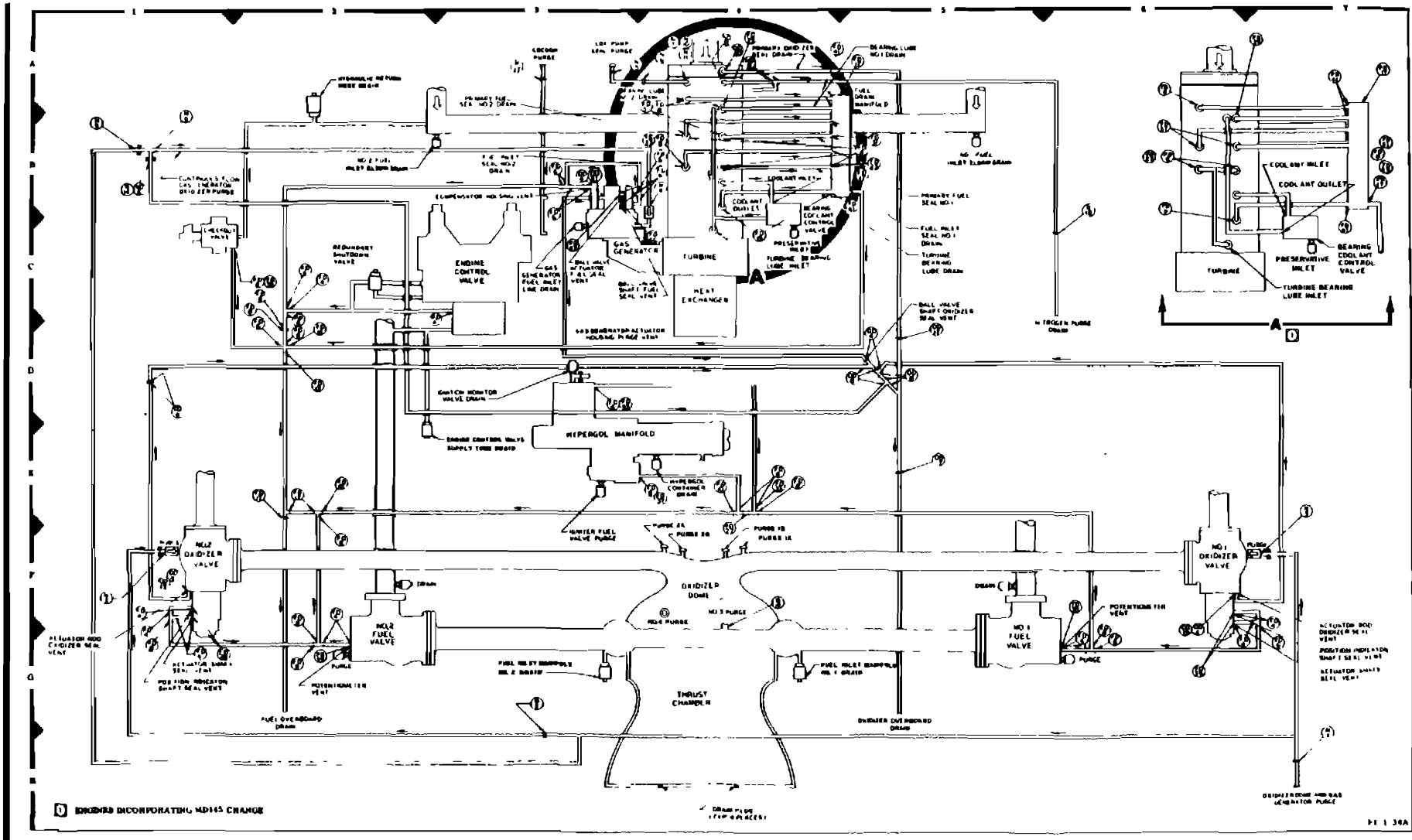

Figure 2-27. Purge and Drain Joint and Seal Schematic (Sheet 1 of 4)

2-70 Change No 9 - 4 November 1970

| Joint Information | | | Seal Information | | | Environment | | Number of Fasteners |
|--|-------|--|------------------|----------|---------|----------------|-----------------|---------------------|
| Zone | Code | Description | Type | Material | ID, in. | Pressure, psig | Temperature, °F | |
| <u>OXIDIZER PURGE AND DRAIN JOINTS</u> | | | | | | | | |
| B3,D1, D5,F1, F6 | OD-4 | Oxidizer Drain Line | F | S | 0.25 | 10 | -100 to +100 | 1 |
| D5 | OD-8 | Oxidizer Drain Line | F | S | 0.50 | 10 | -100 to +100 | 1 |
| D5 | OD-17 | Oxidizer Overboard Drain Line | NA | TS | 1.350 | 10 | -100 to +100 | 4 |
| E5 | | | | | | | | |
| F1 | OD-19 | No. 1 and 2 LOX Valve Actuator Shaft Drain | KB | TS | 0.451 | 10 | -100 to +100 | 1 |
| F6 | | | | | | | | |
| A4 | OD-20 | Oxidizer Drain Line | F | S | 1.25 | 10 | -100 to +100 | 1 |
| B3 | OD-21 | Gas Generator Ball Valve LOX Vent Port (2 seals) | KB | TS | 0.451 | 10 | -100 to +100 | 1 |
| <u>NITROGEN PURGE AND DRAIN JOINTS</u> | | | | | | | | |
| H7 | N-1 | Crossover to LOX Dome and Gas Generator Purge | GO | VA | 0.735 | 1,000 | 0-130 | 4 |
| H3 | N-2 | Purge Supply Line to No. 2 MLV | GO | VA | 0.735 | 1,000 | 0-130 | 4 |
| F1 | N-3 | Purge Line to No. 1 and 2 Check Valves (2 seals) | GO | VA | 0.735 | 1,000 | 0-130 | 4 |
| F7 | | | | | | | | |
| B4 | N-4 | Purge Line to GG Ball Valve Check Valve | NA | TS | 1.026 | 1,000 | 0-130 | 4 |
| A3 | N-5 | Pump LOX Seal Purge Crossover Line to Hard Line | GO | VA | 1.125 | 100 | 0-130 | 4 |
| A4 | N-6 | Hard Line Joint (Pump LOX Seal Purge) | GO | VA | 0.571 | 100 | 0-130 | 4 |
| B1 | | | | | | | | |
| B1 | N-9 | Gas Generator Bypass Oxidizer Manifold Purge | GO | VA | 0.571 | 100 | 0-130 | 4 |
| A4 | N-10 | No. 1 Bearing Purge Adapter to Pump | OR | BN | 0.468 | 100 | 0-130 | 1 |
| A4 | N-11 | No. 1 Bearing Purge Line to Adapter Fuel Pump | OR | BN | 0.426 | 100 | 0-130 | 1 |

Figure 2-27. Purge and Drain Joint and Seal Schematic (Sheet 2 of 4)

| Joint Information | | | Seal Information | | | Environment | | Number of Fasteners |
|--|-------|--|------------------|----------|---------|----------------|----------------|---------------------|
| Zone | Code | Description | Type | Material | ID, in. | Pressure, psig | Temperature, F | |
| <u>NITROGEN PURGE AND DRAIN JOINTS (continued)</u> | | | | | | | | |
| F4 | N-13 | Calip Switch Checkout Line | OR | VA | 0.351 | 1,090 | 0-130 | 1 |
| B1 | N-14 | Gas Generator Bypass Oxidizer Manifold Purge | KB | TS | 0.577 | 10-400 | 0-130 | 1 |
| A3 | N-17 | Purge to Crossover (Insulation) | GO | VA | 0.735 | 175 | 0-130 | 4 |
| C6 | N-18 | Purge Overboard Drain Line | OR | SN | 0.688 | 10 | 0-130 | 4 |
| B1 | ND-6 | Purge Drain Lines | F | S | 0.375 | 10 | 0-130 | 1 |
| A4 | ND-8 | Purge Drain Lines | F | S | 0.50 | 10 | 0-130 | 1 |
| <u>FUEL PURGE AND DRAIN JOINTS</u> | | | | | | | | |
| A4, B4, C2, C3, F1, F6, F7, G2, G6 | FD-4 | Fuel Drain Lines | F | S | 0.25 | 10 | 0-130 | 1 |
| B3, B4, C2, D3, E4, F1, G2, G6, G7 | FD-6 | Fuel Drain Lines | F | S | 0.375 | 10 | 0-130 | 1 |
| A4, B4, D2, E2, E4, G2, G6, B6, B7 | FD-8 | Fuel Drain Lines | F | S | 0.50 | 10 | 0-130 | 1 |
| E2, E4 | FD-10 | Fuel Drain Lines | F | S | 0.625 | 10 | 0-130 | 1 |
| D2, E2 | FD-12 | Fuel Drain Lines | F | S | 0.75 | 10 | 0-130 | 1 |
| D2 | FD-16 | Fuel Drain Lines | F | S | 1.0 | 10 | 0-130 | 1 |
| A5, B7 B5, C7 E2 | FD-17 | Drain Manifold Cover and Outlet Line (3 seals) | GO | VA | 2.00 | 10 | 0-130 | 4 |

Figure 2-27. Purge and Drain Joint and Seal Schematic (Sheet 3 of 4)

| Joint Information | | | Seal Information | | | Environment | | |
|--|-------|---|------------------|----------|---------|----------------|-----------------|---------------------|
| Zone | Code | Description | Type | Material | ID, in. | Pressure, psig | Temperature, °F | Number of Fasteners |
| FUEL PURGE AND DRAIN JOINTS (continued) | | | | | | | | |
| B4, C6 | FD-19 | Turbine Bearing Lube to Drain Manifold (2 seals) | GO | VA | 0.735 | 10 | 0-130 | 4 |
| B4, B6, B7 | FD-23 | Fuel Inlet Drain Lines (4 seals) | OR | VA | 0.924 | 10 | 0-130 | 1 |
| A4, B6 | FD-25 | Fuel Inlet Lube Bearing Drain Inboard | OR | VA | 0.644 | 10 | 0-130 | 1 |
| E4 | FD-27 | Reducer in Fuel Overboard Drain Line | OR | VA | 0.468 | 10 | 0-130 | 1 |
| F1 F6 | FD-29 | No. 1 and 2 LOX Valve Drain to Valve (4 seals) | KB | TS | 0.451 | 10 | 0-130 | 1 |
| A4 B4, B6, B7 | FD-31 | Primary Fuel Seal Drain No. 1 and 2 (4 seals) | OR | VA | 0.644 | 10 | 0-130 | 1 |
| E4 | FD-33 | Ignition Monitor Valve Vent Drain (3 seals) | OR | VA | 0.644 | 10 | 0-130 | 1 |
| G2 G6 | FD-35 | Main Fuel Valve Vent Drain (4 seals) | KB | GS | 0.451 | 10 | 0-130 | 1 |
| E4 | FD-37 | Igniter Fuel Valve Vent | OR | VA | 0.468 | 10 | 0-130 | 1 |
| C1 C2 | FD-39 | Checkout Valve Actuator and Seat Vents (2 seals) | OR | VA | 0.351 | 10 | 0-130 | 1 |
| C1 | FD-40 | Checkout Valve Actuator and Seat Vents (1 seal) | OR | VA | 0.351 | 10 | 0-130 | 1 |
| B4, B7 | FD-41 | Bearing Lube Drain; Inboard and Outboard and Turbine Bearing Lube Drain Lines (3 seals) | GO | VA | 0.735 | 10 | 0-130 | 4 |
| D3 | FD-43 | Igniter Monitor Valve Vent Drain | OR | VA | 0.351 | 10 | 0-130 | 1 |
| C1 | FD-45 | Gas Generator Ball Valve Cavity Vent | KB | TS | 0.451 | 10 | 0-130 | 1 |
| B3 | FD-46 | Gas Generator Ball Valve Shaft Vent | KB | TS | 0.451 | 10 | 0-130 | 1 |
| C1 | FD-47 | Gas Generator Actuator Vent Port | OR | VA | 0.351 | 10 | 0-130 | 1 |

Figure 2-27. Purge and Drain Joint and Seal Schematic (Sheet 4 of 4)

SECTION III NOMINAL
PERFORMANCE CHARACTERISTICS

SECTION III
PERFORMANCE

3-1. SCOPE. This section contains nominal engine performance characteristics, methods for predicting engine variable characteristics, engine influence coefficients, instrumentation parameters used during static tests of a single engine, and flight instrumentation transducer data control and processing. The data is presented as an aid in analyzing and/or determining specific engine performance.

3-2. NOMINAL PERFORMANCE CHARACTERISTICS.

3-3. The nominal performance characteristics contained in the following paragraphs are stated values for optimum engine performance. The allowable tolerance for actual engine performance values are based upon these nominal values.

3-4. NOMINAL ENGINE PERFORMANCE VALUES.

3-5. See figures 3-1 through 3-12A for current nominal engine performance values.

3-6. NOMINAL THRUST CHAMBER PERFORMANCE VALUES.

3-7. See figure 3-13 for nominal thrust chamber performance values.

3-8. NOMINAL TURBOPUMP PERFORMANCE VALUES.

3-9. See figures 3-14 through 3-18 for nominal turbopump values.

| Parameter | Value |
|-------------------|---|
| Thrust | 1,522,000 lb |
| Mixture ratio | 2.27 O/F |
| Specific impulse | 265.1 sec 265.3 sec ^(a) |
| Rated duration | 165 sec |
| Fuel flowrate | 1,755 lb/sec 1,756 lb/sec ^(a) |
| Oxidizer flowrate | 3,984 lb/sec 3,981 lb/sec ^(a) |

(a) Engines incorporating MD128 or MD174 change

Figure 3-1. Nominal Engine Performance Values at Sea Level and Standard Turbopump Inlet Conditions

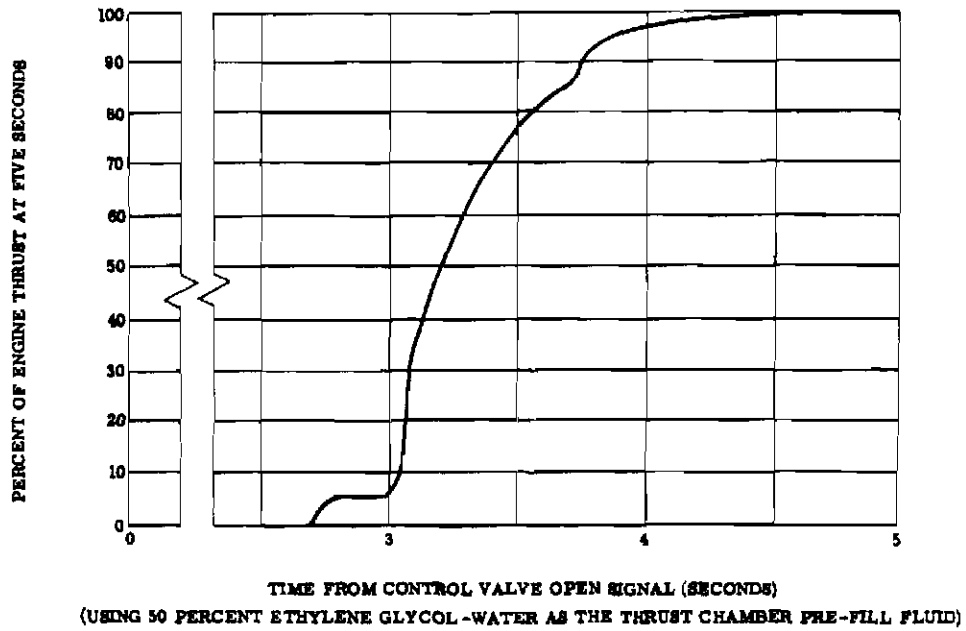

F1-1-35

Figure 3-2. Nominal Thrust Buildup Characteristics

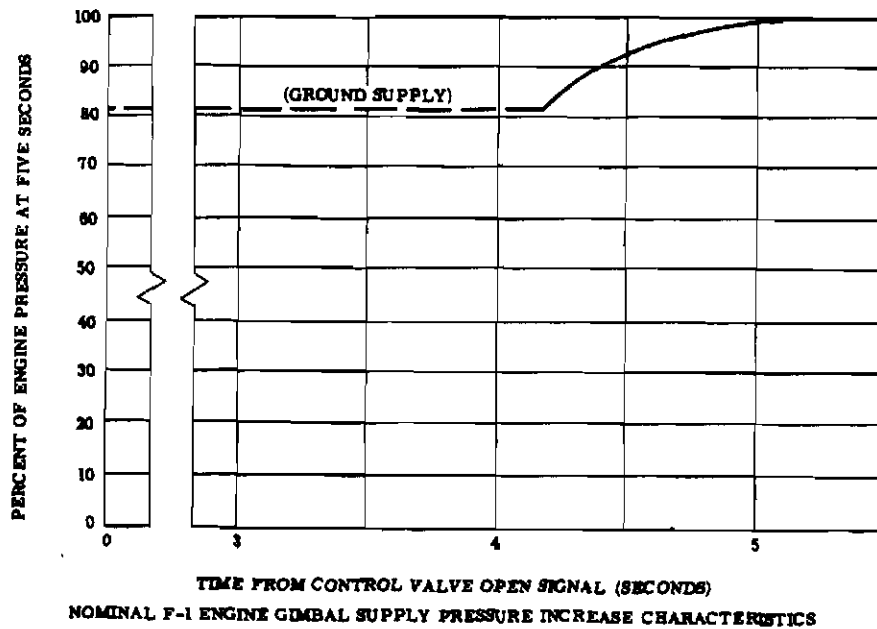

104001-G-31A

Figure 3-3. Gimbal Buildup Characteristics

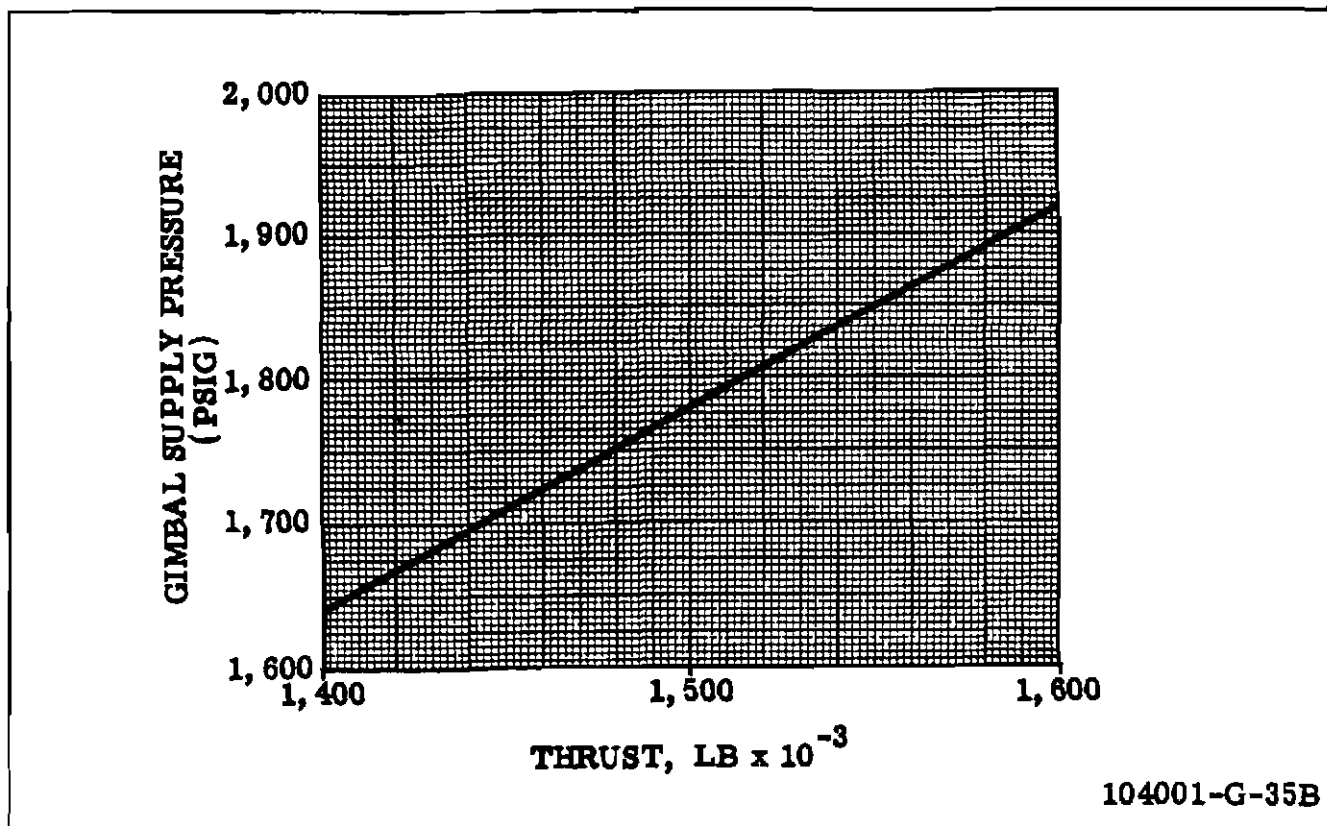

Figure 3-4. Gimbal Supply Pressure Versus Sea-Level Thrust

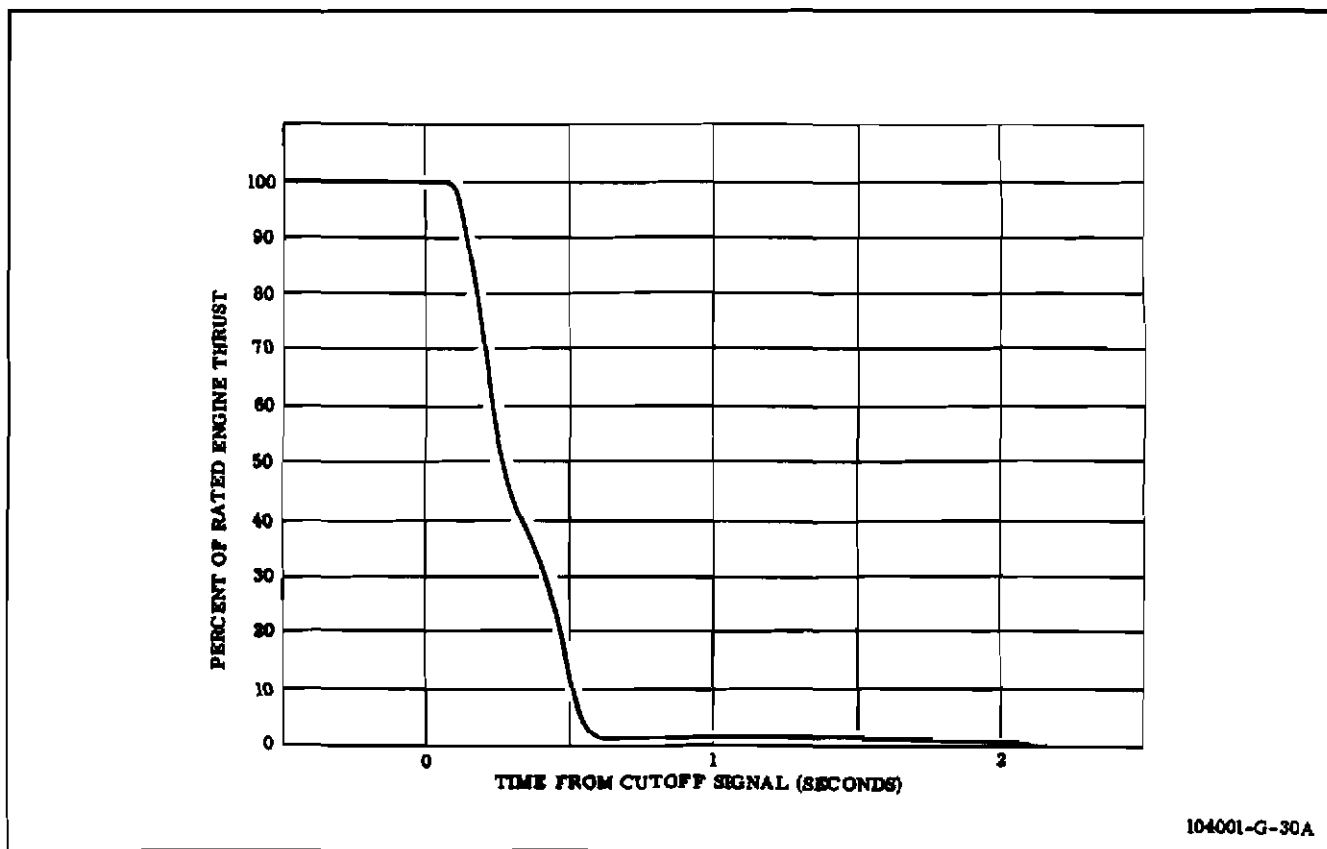

Figure 3-5. Nominal Thrust Decay Characteristics

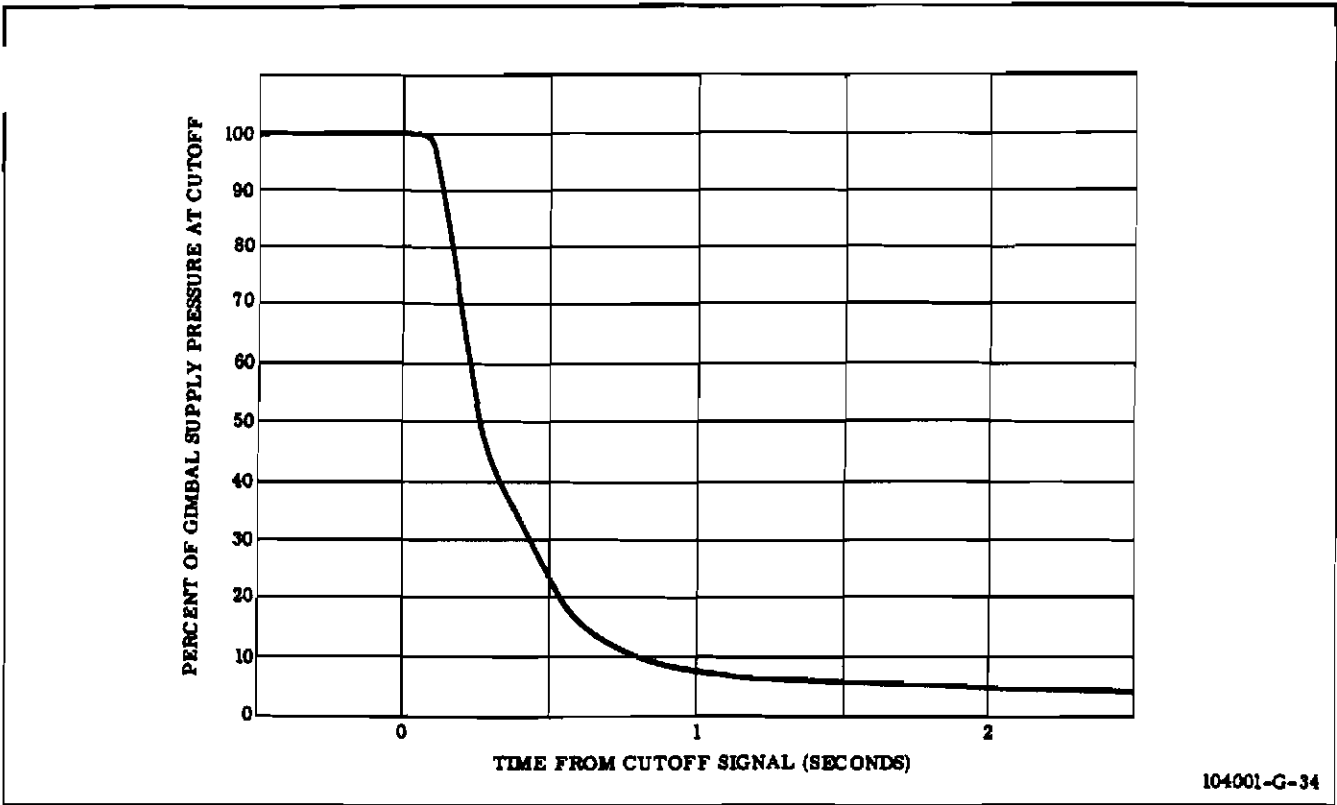

Figure 3-6. Nominal Gimbal Supply Pressure Decrease Characteristics

Figure 3-7 deleted.

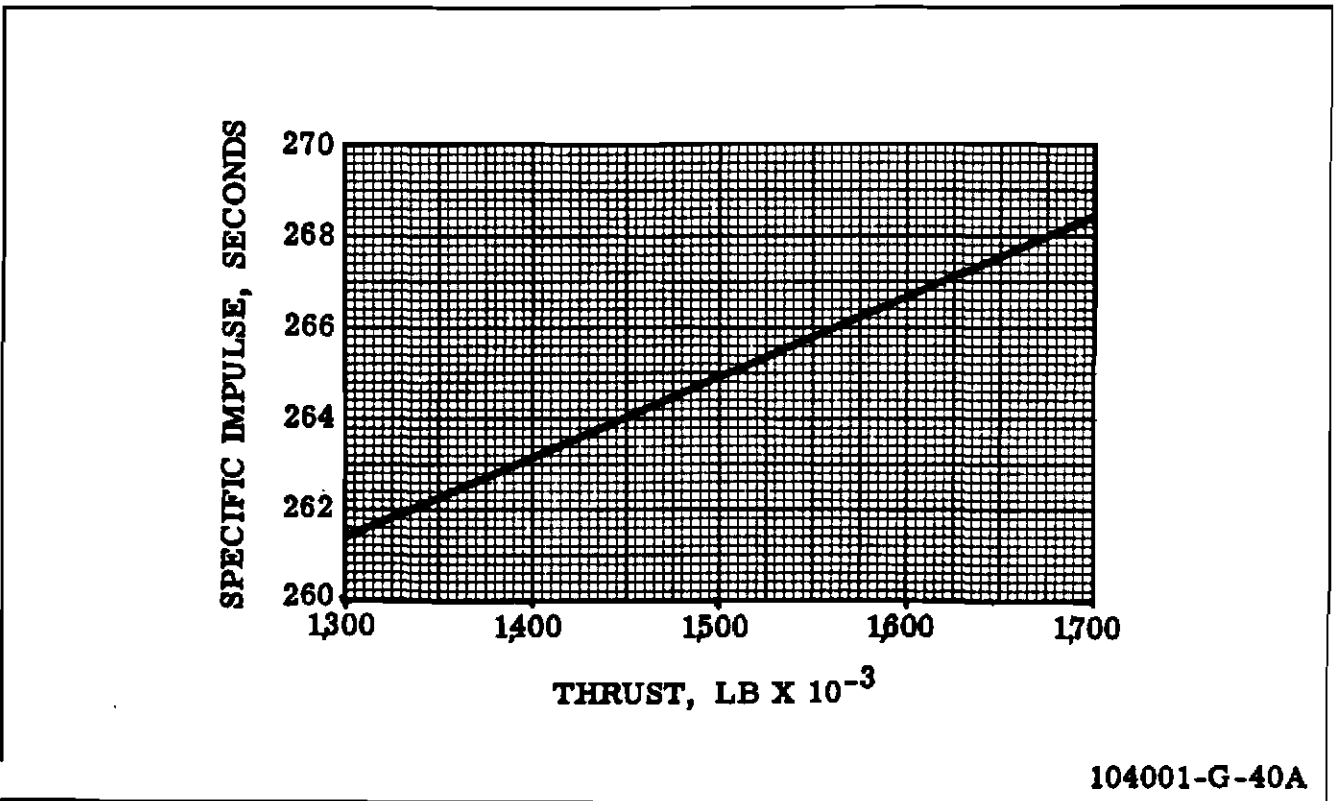

Figure 3-8. Sea-Level Specific Impulse Versus Thrust at Nominal Mixture Ratio and Temperature
 3-4 Change No. 9 - 4 November 1970

Figure 3-9 deleted.

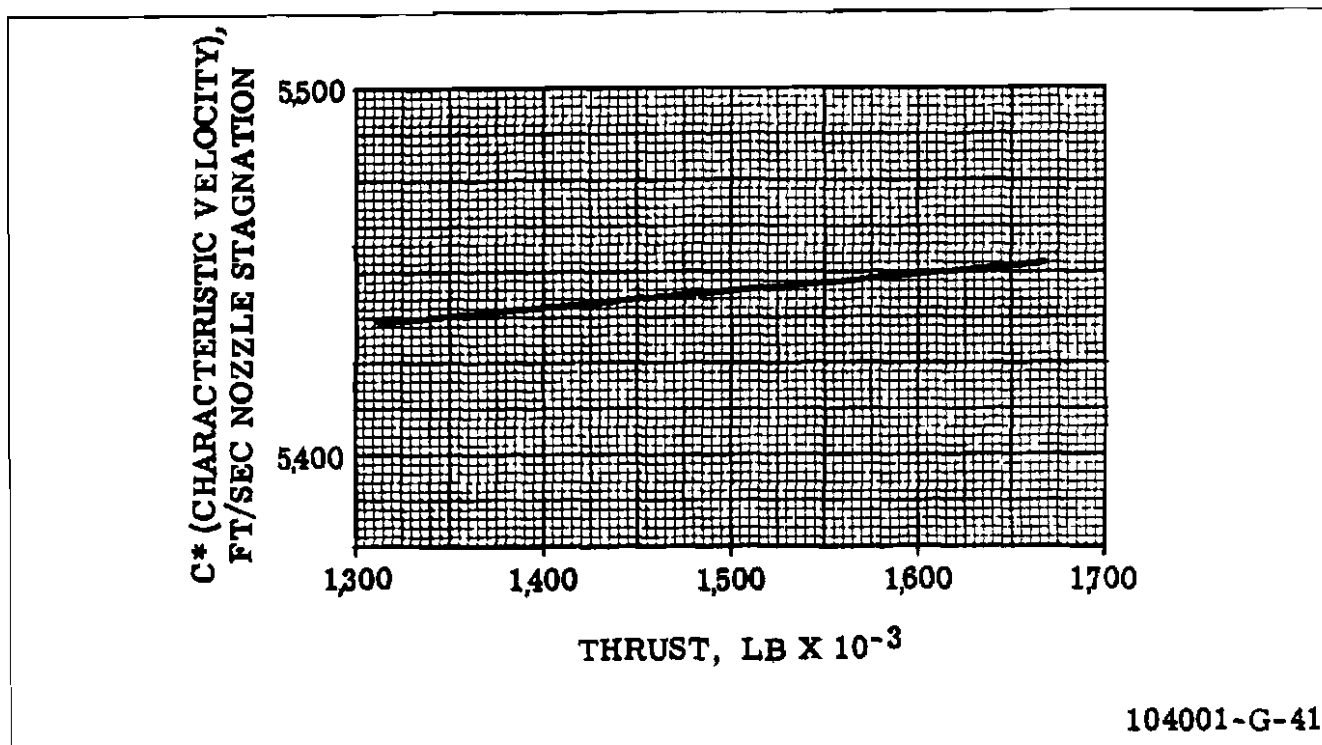

Figure 3-10. Sea-Level Characteristic Velocity Versus Thrust at Nominal Mixture Ratio and Temperature (Engines Not Incorporating MD128 or MD174 Change)

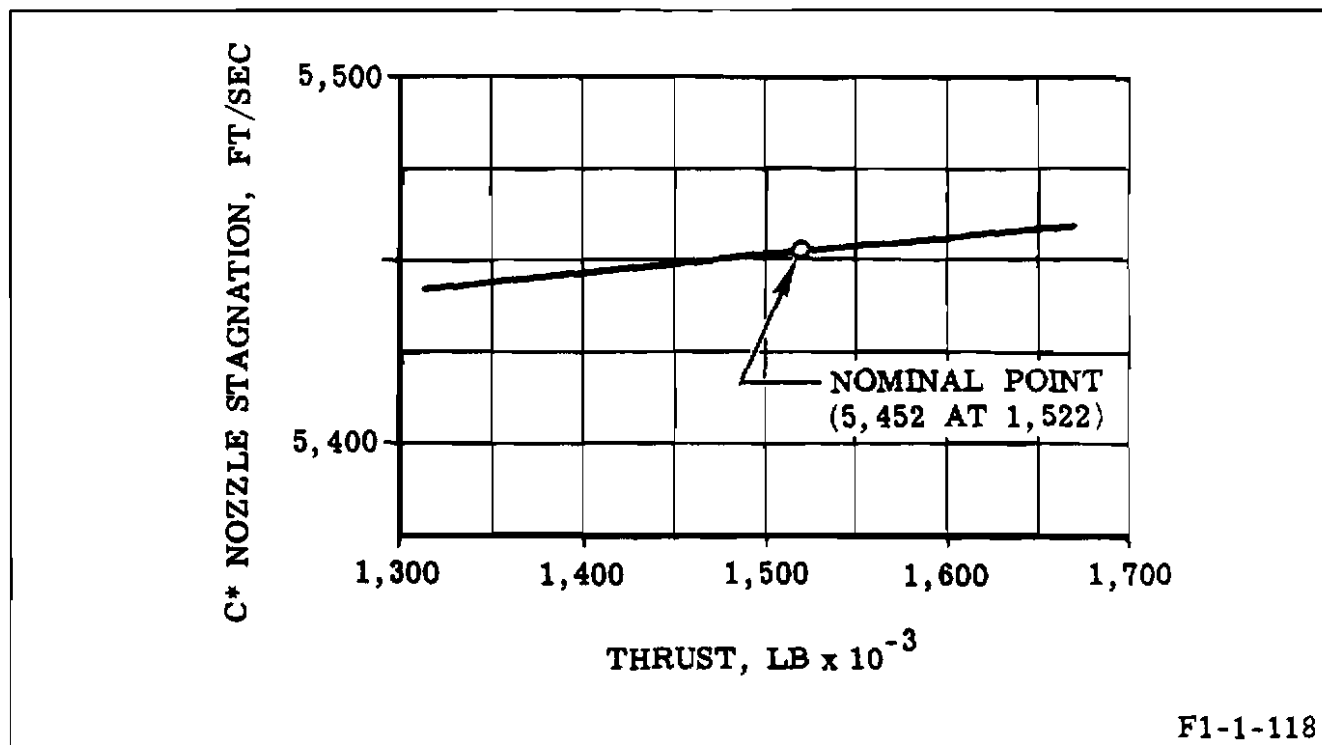
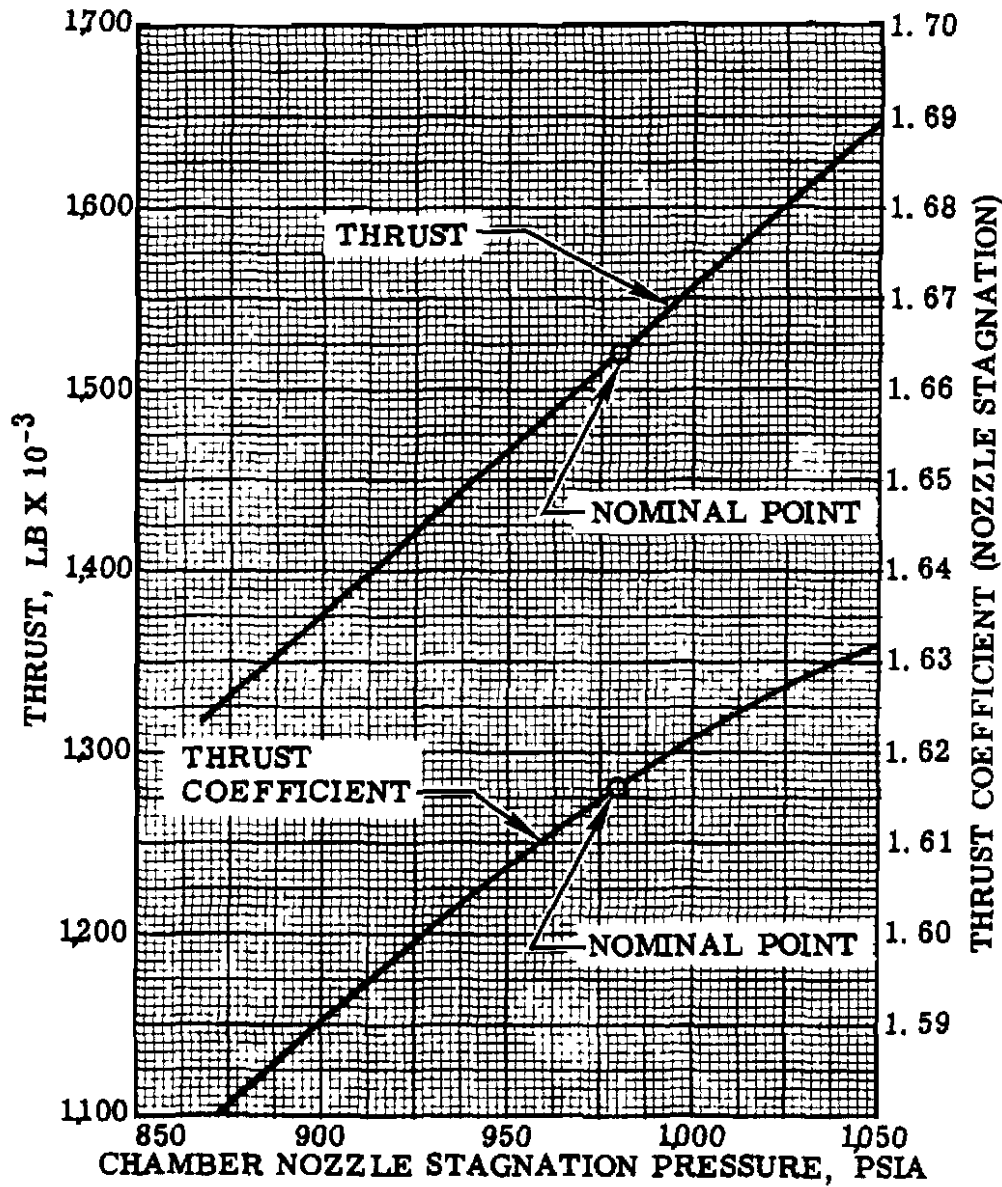
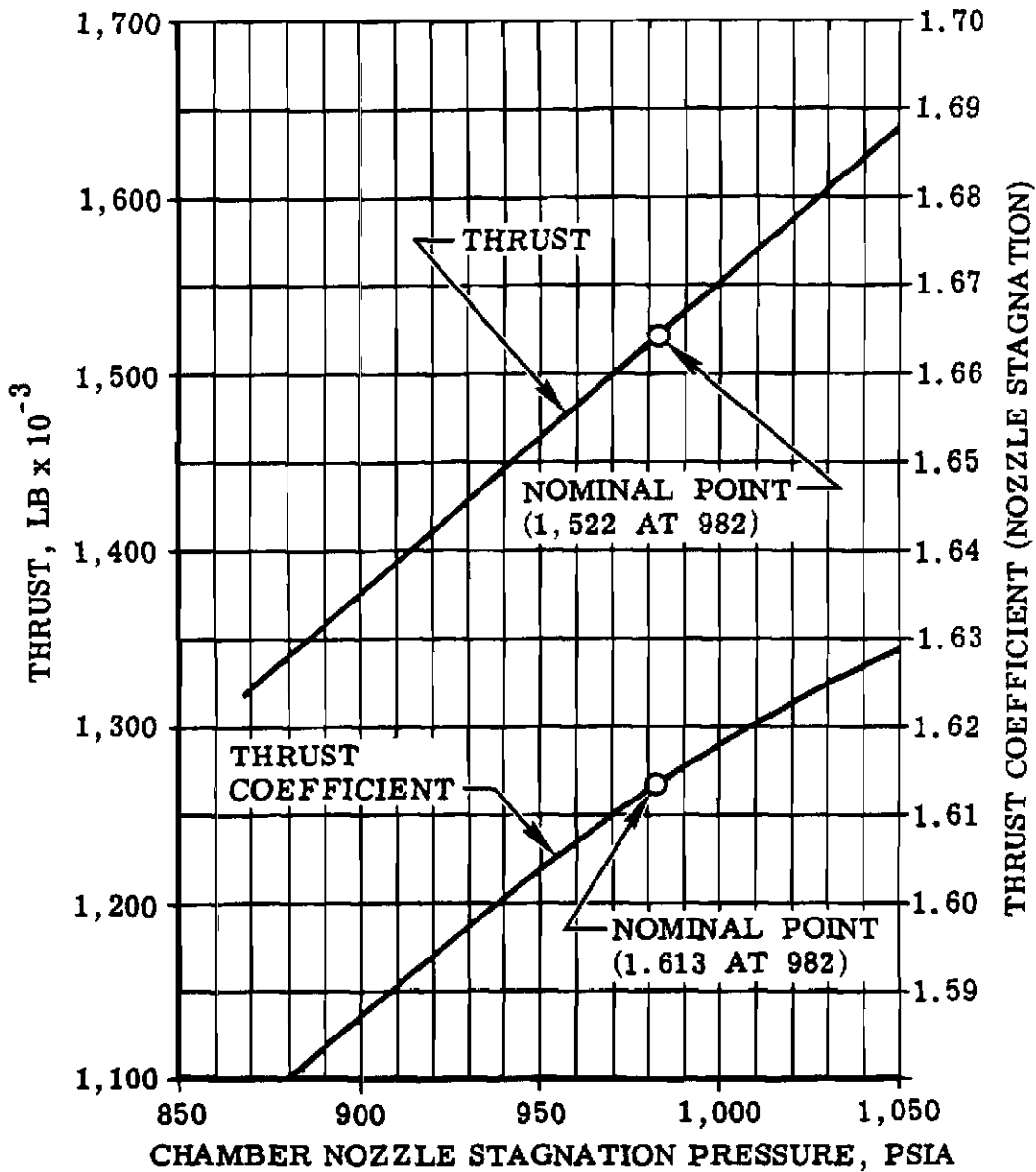

Figure 3-11. Sea-Level Characteristic Velocity Versus Thrust at Nominal Mixture Ratio and Temperature (Engines Incorporating MD128 or MD174 Change)



104001-G-42A

Figure 3-12. Sea-Level Thrust and Thrust Coefficient Versus Chamber Pressure at Nominal Mixture Ratio and Temperature (Engines Not Incorporating MD128 or MD174 Change)



F1-1-119

Figure 3-12A. Sea-Level Thrust and Thrust Coefficient Versus Chamber Pressure at Nominal Mixture Ratio and Temperature (Engines Incorporating MD128 or MD174 Change)

| Parameter | Value |
|--|--|
| Thrust at sea level | 1,522,000 lb |
| Expansion area | 16:1 |
| Throat area | 961.4 sq in. |
| Thrust chamber pressure injector end | 1,123 psia ^(a) 1,125 psia ^(a) |
| Nozzle stagnation | 980 psia ^(a) 982 psia ^(a) |
| Igniter fuel flowrate | 12 lb/sec |
| Total fuel flowrate | 1,633 lb/sec ^(a) 1,636 lb/sec ^(a) |
| Oxidizer flowrate | 3,931 lb/sec ^(a) 3,933 lb/sec ^(a) |
| Mixture ratio | 2.40 O/F |
| Characteristic velocity, Nozzle stagnation | 5,447 ft/sec ^(a) 5,451 ft/sec ^(a) |
| Throat gas stagnation temperature | 5,970° F |
| Throat gas static temperature | 5,328° F |
| Nozzle exit gas static temperature | 1,922° F |
| Thrust chamber wall temperature at throat | 975° F |
| Cooling jacket prefill volume | 105 gal |
| Oxidizer injector pressure drop | 312 psid |
| Fuel injector pressure drop | 96 psid |
| Cooling jacket pressure drop | 265 psid ^(a) 242 psid ^(a) |

(a) Engines incorporating MD128 or MD174 change

Figure 3-13. Nominal Thrust Chamber Performance Values

| Parameter | Value |
|----------------------------|--|
| OXIDIZER PUMP | |
| Total flowrate | 3,986 lb sec 25,061 gpm 25,063 gpm ^(a) |
| Inlet pressure (total) | 65 psia |
| Discharge pressure (total) | 1,598 psia 1,602 psia ^(a) |
| Required power | 30,270 bhp ^(a) 30,332 bhp ^(a) |
| Speed | 5,488 rpm ^(a) 5,492 rpm ^(a) |
| Torque | 28,967 ft-lb ^(a) 29,022 ft-lb ^(a) |
| FUEL PUMP | |
| Total flowrate | 1,756 lb/sec 15,620 gpm |
| Inlet pressure (total) | 45 psia |
| Discharge pressure (total) | 1,857 psia ^(a) 1,870 psia ^(a) |
| Required power | 22,656 bhp ^(a) 22,814 bhp ^(a) |
| Speed | 5,488 rpm ^(a) 5,492 rpm ^(a) |
| Torque | 21,681 ft-lb ^(a) 21,829 ft-lb ^(a) |
| TURBINE | |
| Inlet temperature | 1,453° F |
| Exit temperature | 1,152° F 1,138° F ^(a) |
| Inlet pressure (total) | 918 psia ^(a) 945 psia ^(a) |
| Exit static pressure | 58 psia |
| Gas flowrate | 172 lb sec 167 lb sec ^(a) |
| Developed power | 52,926 bhp ^(a) 53,146 bhp ^(a) |
| Speed | 5,488 rpm ^(a) 5,492 rpm ^(a) |
| Torque | 50,649 ft-lb ^(a) 50,851 ft-lb ^(a) |

(a) Engines incorporating MD128 or MD174 change

Figure 3-14. Nominal Turbopump Performance Values

Figure 3-15 deleted.

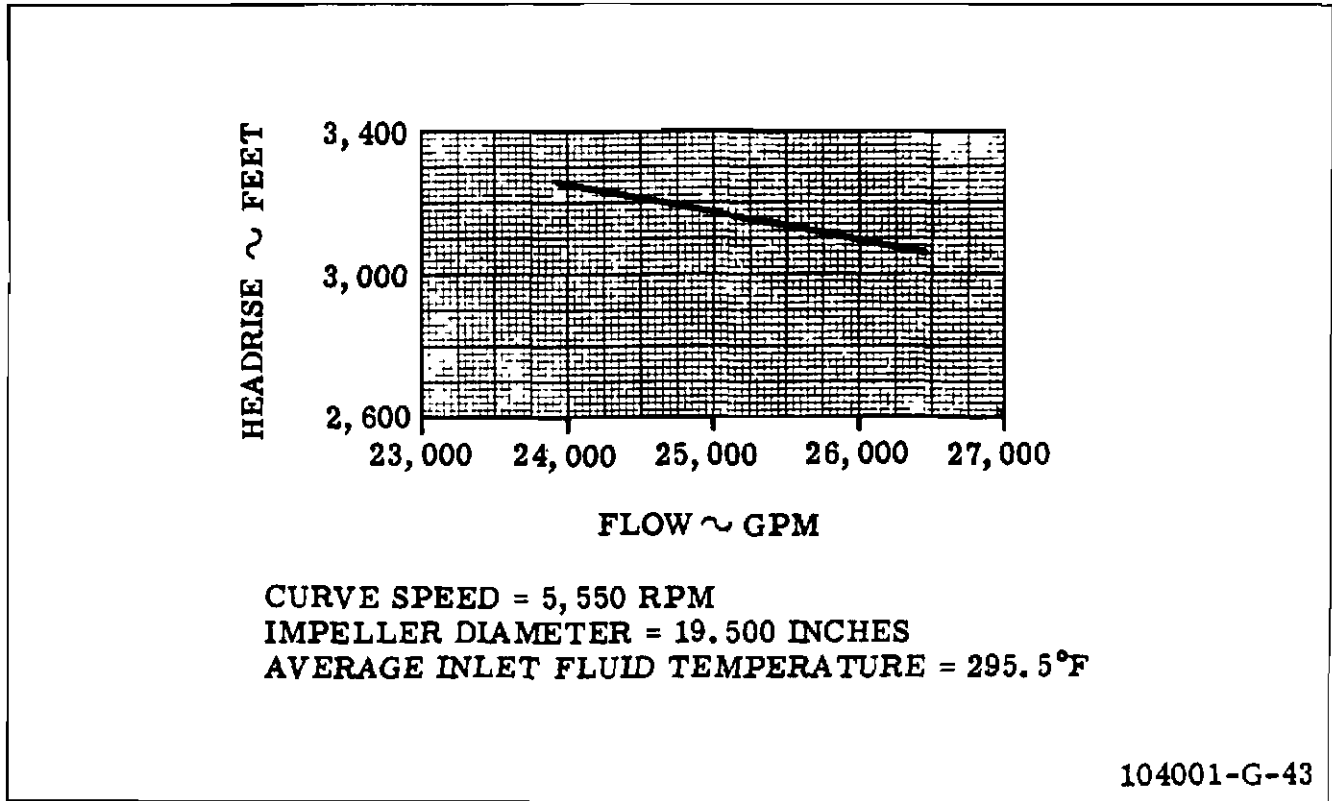

Figure 3-16. Oxidizer Pump Developed Head Versus Volumetric Flowrate

Figure 3-17 deleted.

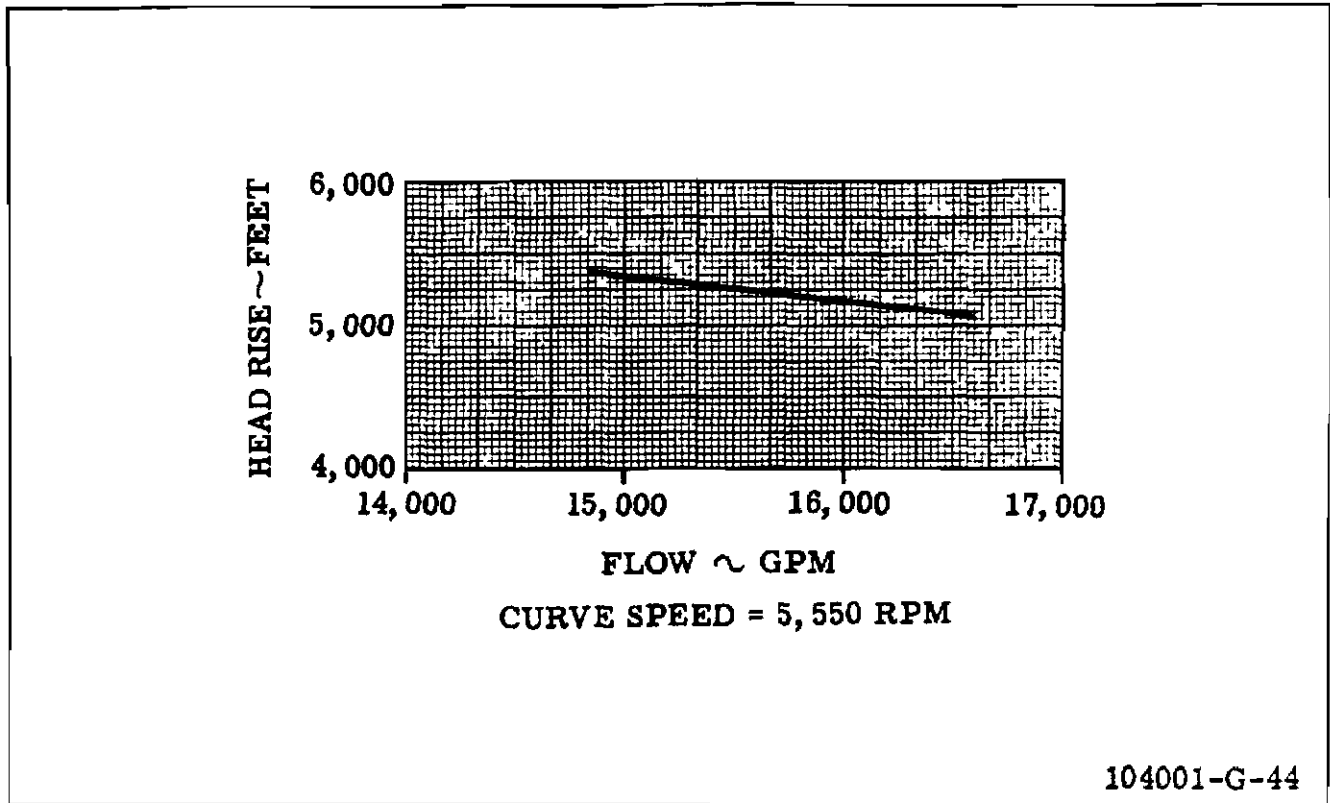

Figure 3-18. Fuel Pump Developed Head Versus Volumetric Flowrate

3-10. NOMINAL GAS GENERATOR PERFORMANCE VALUES.

3-11. See figure 3-19 for nominal gas generator performance values.

| Parameter | Value |
|--|--|
| GAS GENERATOR | |
| Injector end pressure | 956 psia 980 psia ^(a) |
| Fuel flowrate | 121.1 lb/sec 118.0 lb/sec ^(a) |
| Oxidizer flowrate | 50.4 lb/sec ^(a) 49.0 lb/sec |
| Mixture ratio | 0.417 O/F ^(a) 0.416 O/F ^(a) |
| Discharge temperature | 1,453° F |
| ^(a) Engines incorporating MD128 or MD174 change | |

Figure 3-19. Nominal Gas Generator Performance Values

3-12. NOMINAL HEAT EXCHANGER PERFORMANCE VALUES.

3-13. See figure 3-20 for nominal heat exchanger performance values.

| Parameter | Temperature Range | Nominal Value |
|-----------------|-------------------|---------------|
| Oxygen flowrate | 400° to 500° F | 4.0 lb sec |
| Helium flowrate | 185° to 285° F | 0.6 lb/sec |

Figure 3-20. Nominal Heat Exchanger Performance Values

3-14. ENGINE START CHARACTERISTICS.

3-15. Engine start characteristics (figures 3-21 through 3-26) are presented as nominal values. Refer to R-3896-11 for minimum and maximum values.

| Valve | Switch Times (Seconds) | Potentiometer Times (Seconds) |
|-----------------------------|---------------------------|----------------------------------|
| Oxidizer valve | 0.320 | 0.535 |
| Gas generator ball valve | 0.170 | |
| Fuel valve | 0.635 | 0.735 |

Figure 3-21. Nominal Valve Opening Times for Mainstage

| Parameter | Value |
|--|-----------|
| Maximum thrust increase for 0.010-second interval, 90-990K lb | 50,000 lb |
| Maximum thrust increase for 0.010-second interval, above 990K lb | 21,000 lb |
| Thrust increase time, 610-1,370K lb | 0.59 sec |
| Oxidizer consumption prior to 90% thrust | 620 gal. |
| Fuel consumption prior to 90% thrust | 128 gal. |

Figure 3-22. Nominal Thrust Buildup and Approximate Propellant Consumption Values for Mainstage

| Parameter | Value ^(a) (Seconds) |
|--|-----------------------------------|
| <u>Engine Control Valve Opening Signal to:</u> | |
| Oxidizer valve starts to open | 0.035 |
| Gas generator ball valve starts to open | 0.140 |
| Fuel valves start to open | 3.570 |
| Time of 100 psig chamber pressure | 3.800 |
| Thrust OK pressure switches pickup | 4.640 |

(a) Values are based on S-IC stage application.

Figure 3-22A. Nominal Start Times From Engine Control Valve Open Signal

All data on pages 3-11 through 3-16 deleted.

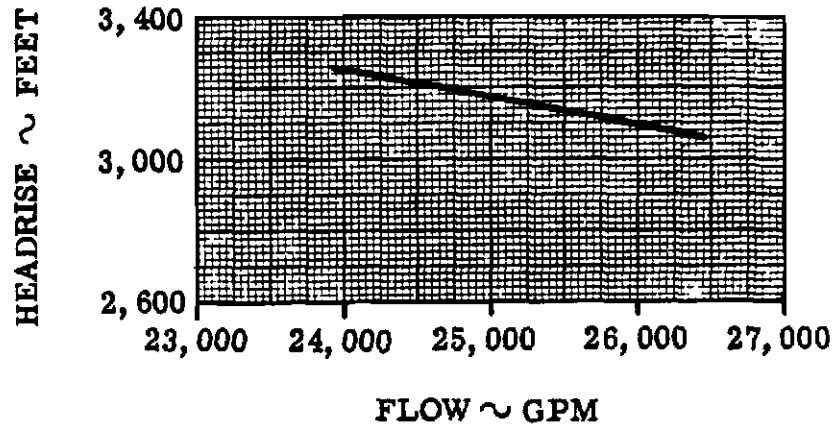

CURVE SPEED = 5,550 RPM
 IMPELLER DIAMETER = 19.500 INCHES
 AVERAGE INLET FLUID TEMPERATURE = 295.5°F

104001-G-43

Figure 3-16. Oxidizer Pump Developed Head Versus Volumetric Flowrate
 (Engines Incorporating MD31 Change)

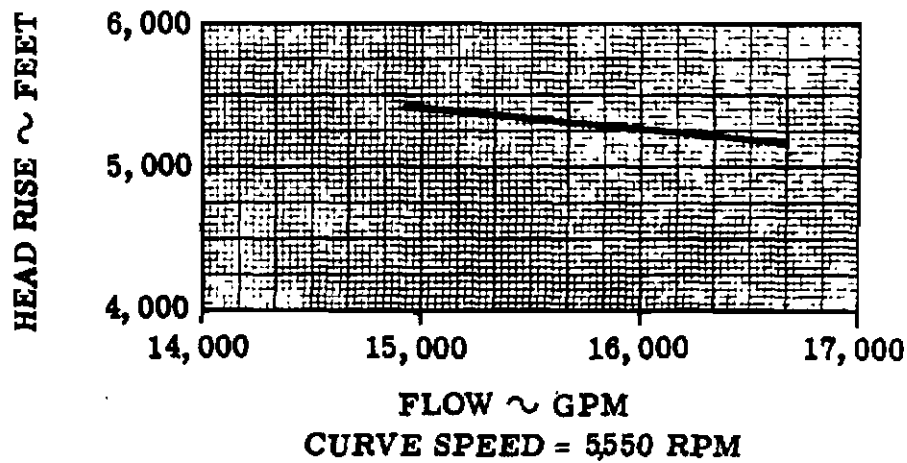

104001-G-22D

Figure 3-17. Fuel Pump Developed Head Versus Volumetric Flowrate
 (Engines Not Incorporating MD31 Change)

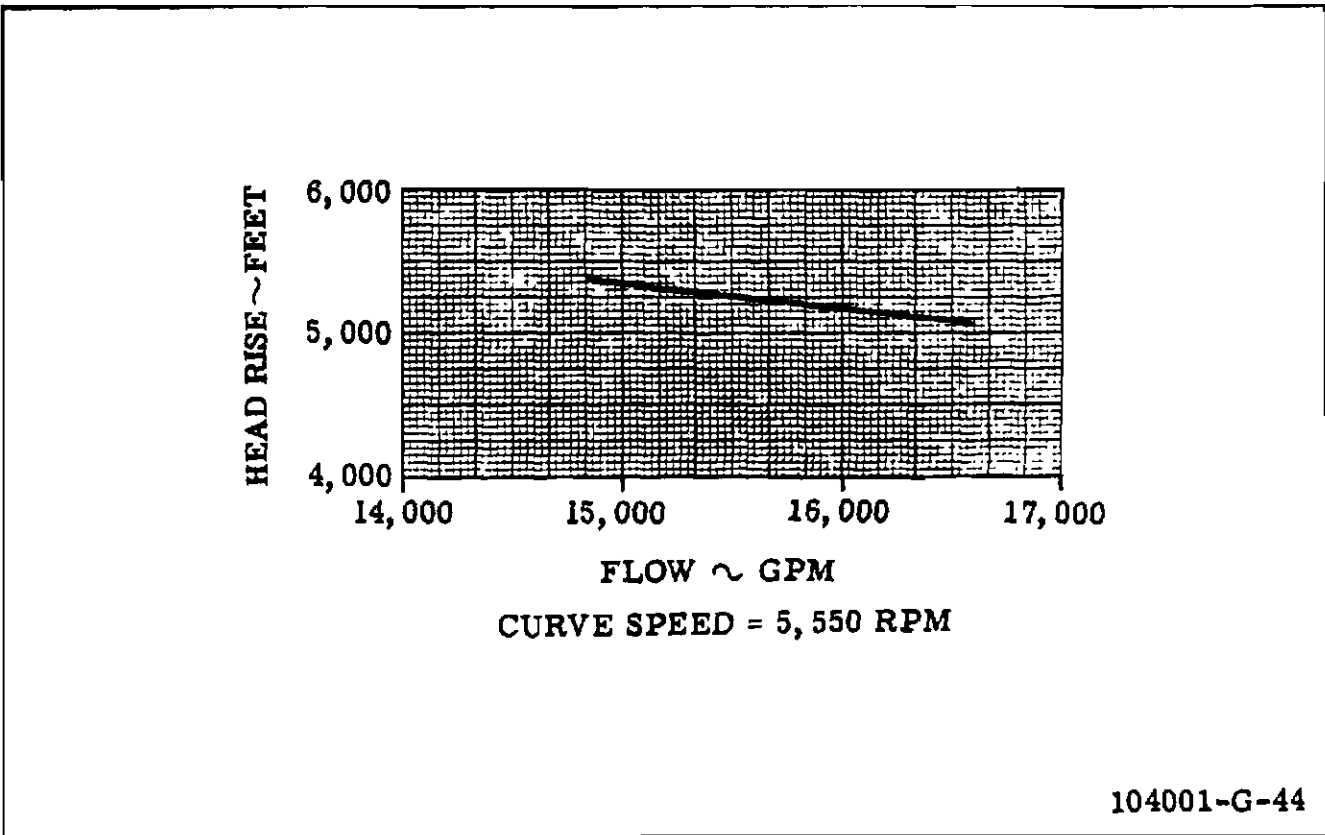

Figure 3-18. Fuel Pump Developed Head Versus Volumetric Flowrate
 (Engines Incorporating MD31 Change)

3-10. NOMINAL GAS GENERATOR PERFORMANCE VALUES.

3-11. See figure 3-19 for nominal gas generator performance values.

| Parameter | Value | | |
|-----------------------|--------------------------|--------------------------|-----------------------------|
| | F-2017 Thru F-2027 | F-2029 Thru F-2065 | F-2066 and Subsequent |
| GAS GENERATOR | | | |
| Injector End Pressure | 918 psia | 956 psia | 986 psia |
| Fuel Flowrate | 117.6 lb/sec | 121.1 lb/sec | 118.5 lb/sec |
| Oxidizer Flowrate | 49.5 lb/sec | 50.4 lb/sec | 49.2 lb/sec |
| Mixture Ratio | 0.421 O/F | 0.417 O/F | 0.416 O/F |
| Discharge Temperature | 1,465° F | 1,453° F | 1,453° F |

Figure 3-19. Nominal Gas Generator Performance Values

3-12. NOMINAL HEAT EXCHANGER PERFORMANCE VALUES.

3-13. See figure 3-20 for nominal heat exchanger performance values.

| Parameter | Temperature Range | Nominal Value |
|--------------------------------|-------------------|---------------|
| Oxygen Flowrate | 400° to 500° F | 4.0 lb/sec |
| Helium Flowrate ^(a) | 100° to 200° F | 0.6 lb/sec |
| Helium Flowrate ^(b) | 185° to 285° F | 0.6 lb/sec |

(a) Engines F-2003 through F-2028
(b) Engines F-2029 and subsequent

Figure 3-20. Nominal Heat Exchanger Performance Values

3-14. ENGINE START CHARACTERISTICS.

3-15. Engine start characteristics (figures 3-21 through 3-27) are presented as nominal values. Refer to R-3896-11 for minimum and maximum values.

a. Valve sequence times in figures 3-21 and 3-22 are for engines not incorporating MD139 change. Valve sequence times in figure 3-22A are for engines incorporating MD139 change. The following valve opening times are mainstage values and are potentiometer times, except for the gas generator ball valve, which is switch time.

| Parameter | Nominal Value (Seconds) |
|--------------------------|-------------------------------|
| No. 1 Oxidizer Valve | 0.600 0.550 ^(a) |
| No. 2 Oxidizer Valve | 0.600 0.550 ^(a) |
| Gas Generator Ball Valve | 0.220 0.175 ^(a) |
| No. 1 Fuel Valve | 0.700 0.700 ^(a) |
| No. 2 Fuel Valve | 0.700 0.700 ^(a) |

(a) Engines incorporating MD139 change

b. Thrust buildup and approximate propellant consumption are to mainstage as follows:

| Parameter | Nominal Value |
|--|---|
| Maximum Thrust Buildup Rate, 90-990K | 20,000,000 lb/sec |
| Maximum Thrust Buildup Rate, Above 990K | 10,000,000 lb/sec |
| Nominal Value Thrust Buildup Rate, 90-990K | 5,300,000 lb/sec 4,900,000 lb/sec ^(a) |
| Oxidizer Consumption Prior to 90% Thrust | 626 gallons 620 gallons ^(a) |
| Fuel Consumption Prior to 90% Thrust | 129 gallons 128 gallons ^(a) |

(a) Engines incorporating MD139 change

c. The following start times (based on S-IC stage application) are referenced from engine control valve opening signal to:

| Parameter | Nominal Value (Seconds) |
|---|-------------------------------|
| Oxidizer Valve Start to Open | 0.038 |
| Gas Generator Ball Valve Starts to Open | 0.150 |
| Fuel Valves Start to Open | 2.900 3.200 ^(a) |
| Time of 100 psig Chamber Pressure | 3.000 3.300 ^(a) |
| 90% Thrust | 3.700 4.000 ^(a) |

(a) Engines incorporating MD32 change

3-16. ENGINE STOP CHARACTERISTICS.

3-17. Engine stop characteristics are presented as nominal values. Refer to R-3896-11 for minimum and maximum values.

a. Valve sequence times in figure 3-27 are for engines not incorporating MD139 change. Valve sequence times in figure 3-28 are for engines incorporating MD139 change. Valve closing times are potentiometer times except for the gas

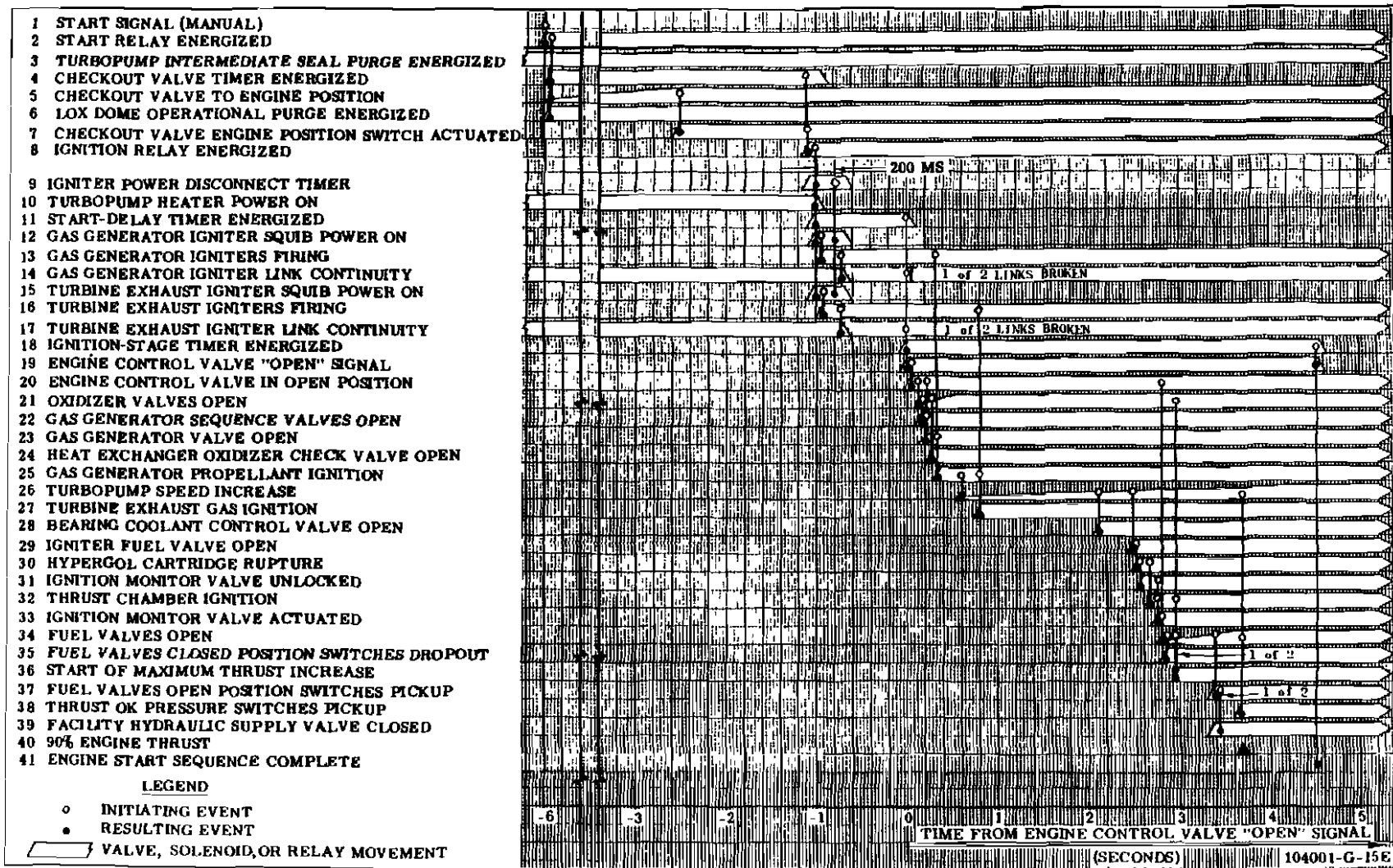

Figure 3-21 Engine Start Sequence Flow (Typical) (Engines Not Incorporating M132 Change)

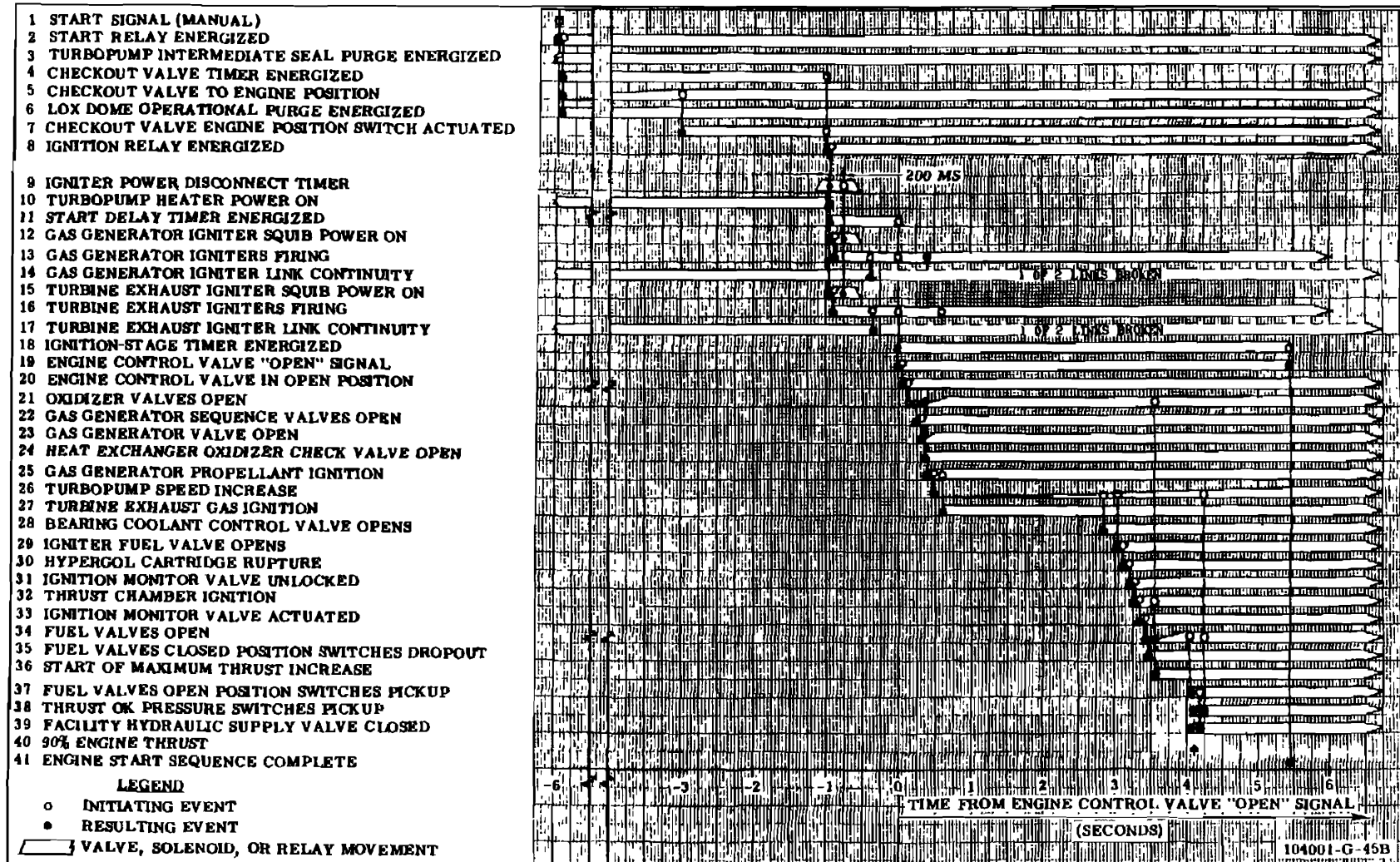

Figure 3-22. Engine Start Sequence Flow (Typical) (Engines Incorporating MD32 Change)

generator ball valve, which is switch time.
 The following cutoff times (based on S-1C stage application) are referenced from the engine control valve closing signal to:

| <u>Parameter</u> | <u>Milliseconds</u> |
|--|-----------------------------|
| Gas Generator Ball Valve Starts to Close | 30 30 ^(a) |
| Gas Generator Ball Valve Closing Time | 120 95 ^(a) |
| Oxidizer Valve Starts to Close | 30 30 ^(a) |
| Oxidizer Valve Closing Time | 610 550 ^(a) |
| Fuel Valve Starts to Close | 30 30 ^(a) |
| Fuel Valve Closing Time | 880 1,100 ^(a) |

(a) Engines incorporating MD139 change

b. The following is the thrust-decay time from engine control valve closing signal to:

| <u>Parameter</u> | <u>Milliseconds</u> |
|---------------------------------|-------------------------------|
| Chamber Pressure Leaves 100% | 73 74 ^(a) |
| Chamber Pressure Decays to 90% | 133 118 ^(a) |
| Chamber Pressure Decays to 10% | 644 573 ^(a) |
| Chamber Pressure Decays to zero | 1,948 1,864 ^(a) |

(a) Engines incorporating MD139 change

3-18 and 3-19. (Deleted)

Figure 3 22A deleted

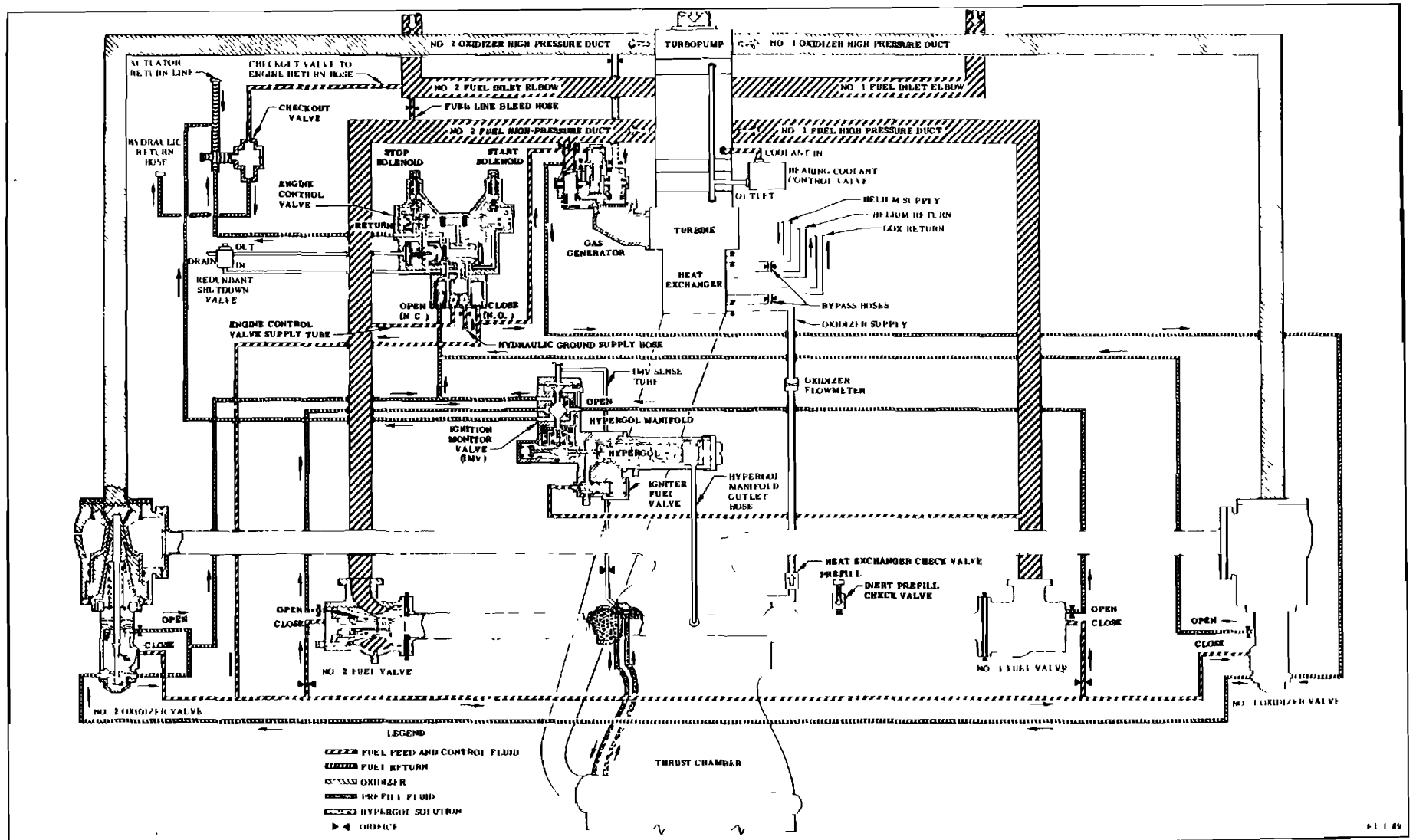

Figure 3 23. Engine Schematic (Pre-Start)

Change No. 7 - 18 August 1969

3 17/3-18

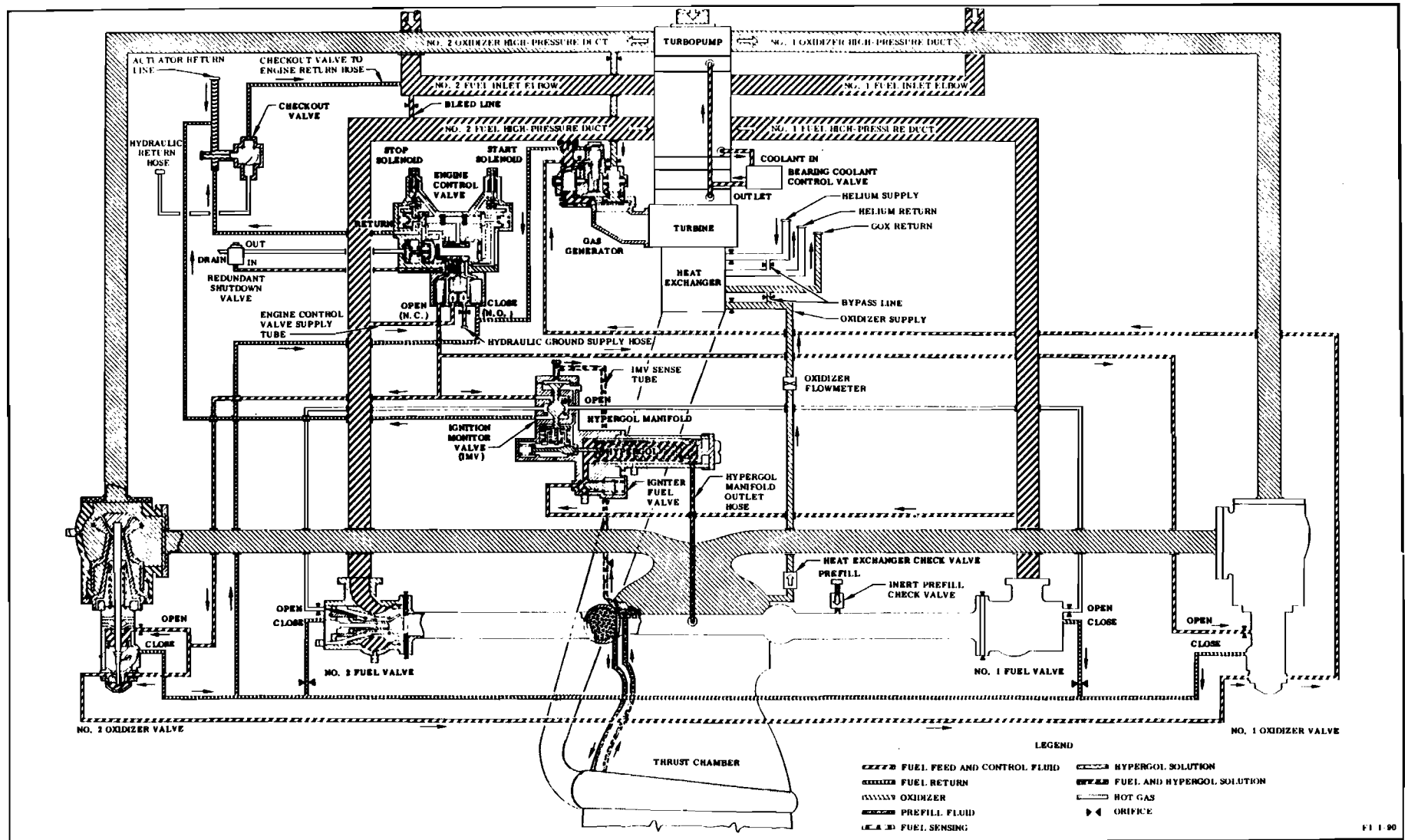
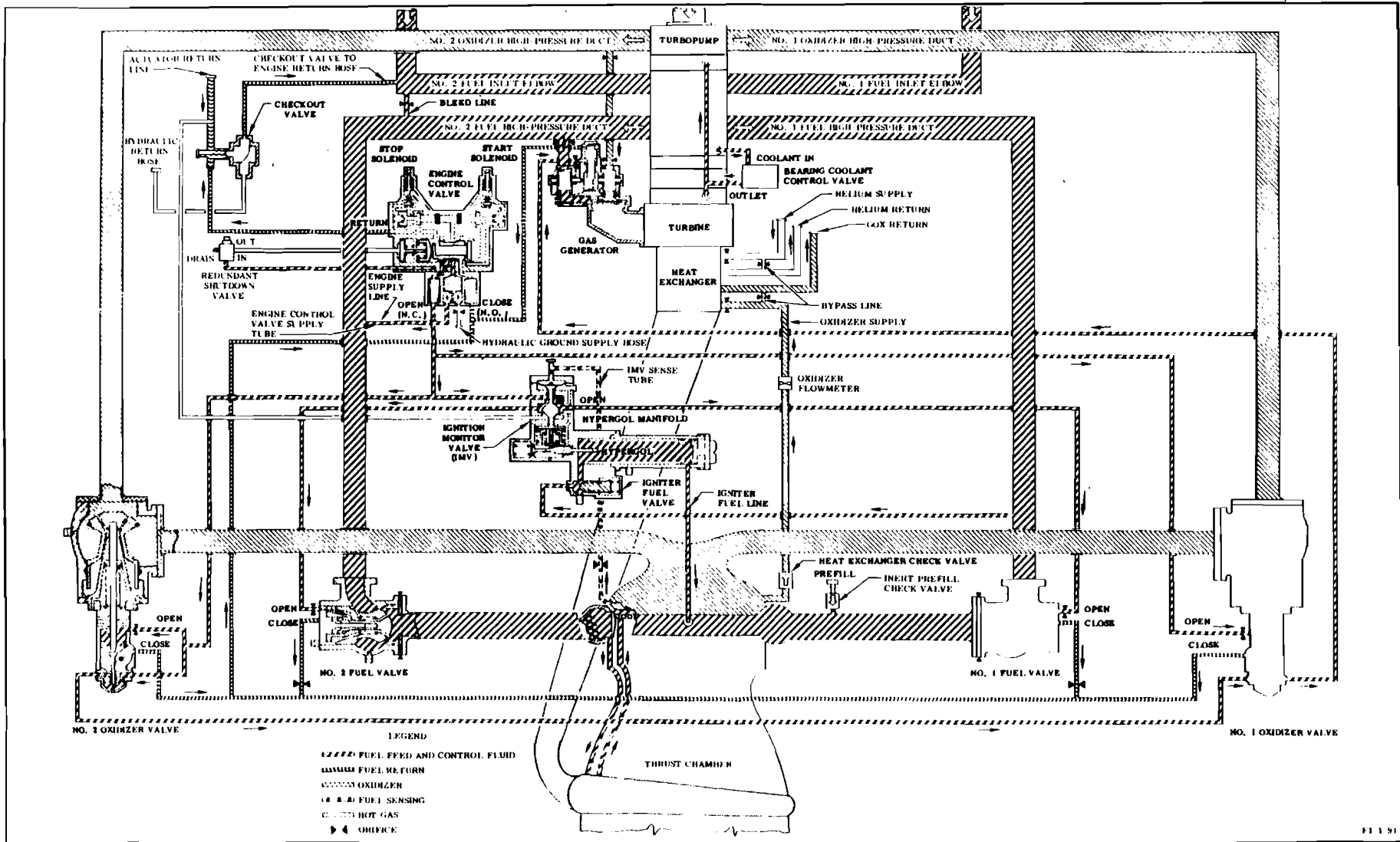

Figure 3-24. Engine Schematic (Ignition)
 Change No. 7 - 18 August 1969 3-19



FI 1 91

Figure 3-25. Engine Schematic (Mainstage)

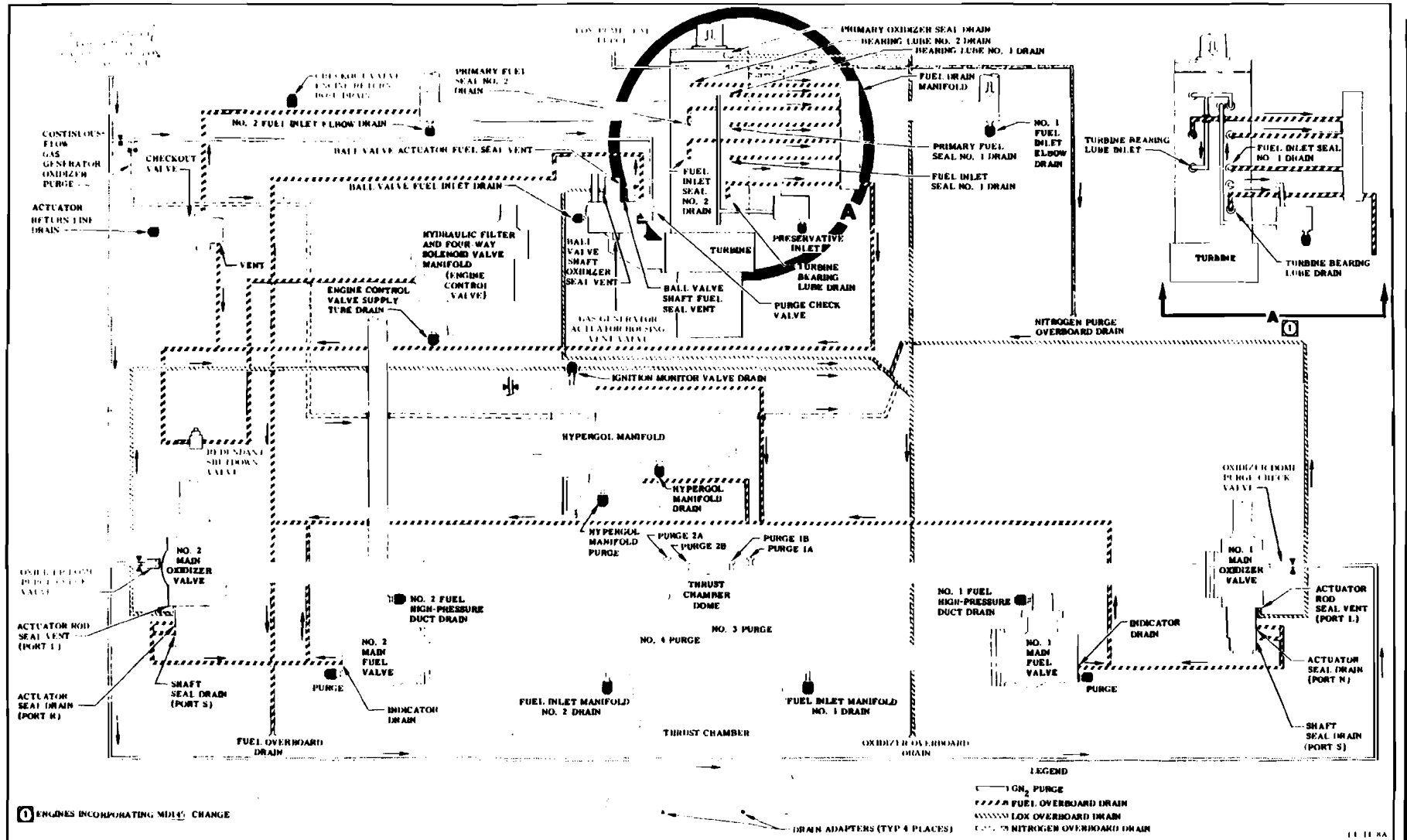

Figure 3-26. Engine Drain and Purge Schematic

Change No. 9 - 4 November 1970

3-21

3-16. ENGINE STOP CHARACTERISTICS.

3-17. Engine stop characteristics (figures 3-27 through 3-28A) are presented as nominal values. Refer to R-3896-11 for minimum and maximum values.

| Valve | Switch Times (Seconds) ^(a) | Potentiometer Times (Seconds) ^(a) |
|---|---------------------------------------|--|
| <u>Engine Control Valve Closing</u> Signal to: | | |
| Gas generator ball valve starts to close | 0.035 | -- |
| Gas generator ball valve closing time | 0.090 | -- |
| Oxidizer valve starts to close | 0.120 | 0.030 |
| Oxidizer valve closing time | 0.325 | 0.540 |
| Fuel valve starts to close | 0.115 | 0.030 |
| Fuel valve closing time | 0.930 | 1.130 |

(a) Values are based on S-IC stage application.

Figure 3-27. Nominal Cutoff Times From Engine Control Valve Stop Signal

| Parameter | Seconds |
|---|---------|
| <u>Engine Control Valve Closing</u> Signal to: | |
| Thrust chamber pressure leaves 100% | 0.074 |
| Thrust chamber pressure decays to 90% | 0.118 |
| Thrust chamber pressure decays to 10% | 0.573 |
| Thrust chamber pressure decays to zero | 1.864 |

Figure 3-28. Nominal Thrust Decay Time From Engine Control Valve Closing Signal

| Parameter | Value |
|---|----------------|
| Maximum thrust decrease for 0.075-second interval | 448,000 lb |
| Cutoff impulse | 464,000 lb sec |

Figure 3-28A. Nominal Thrust Decay and Cutoff Impulse

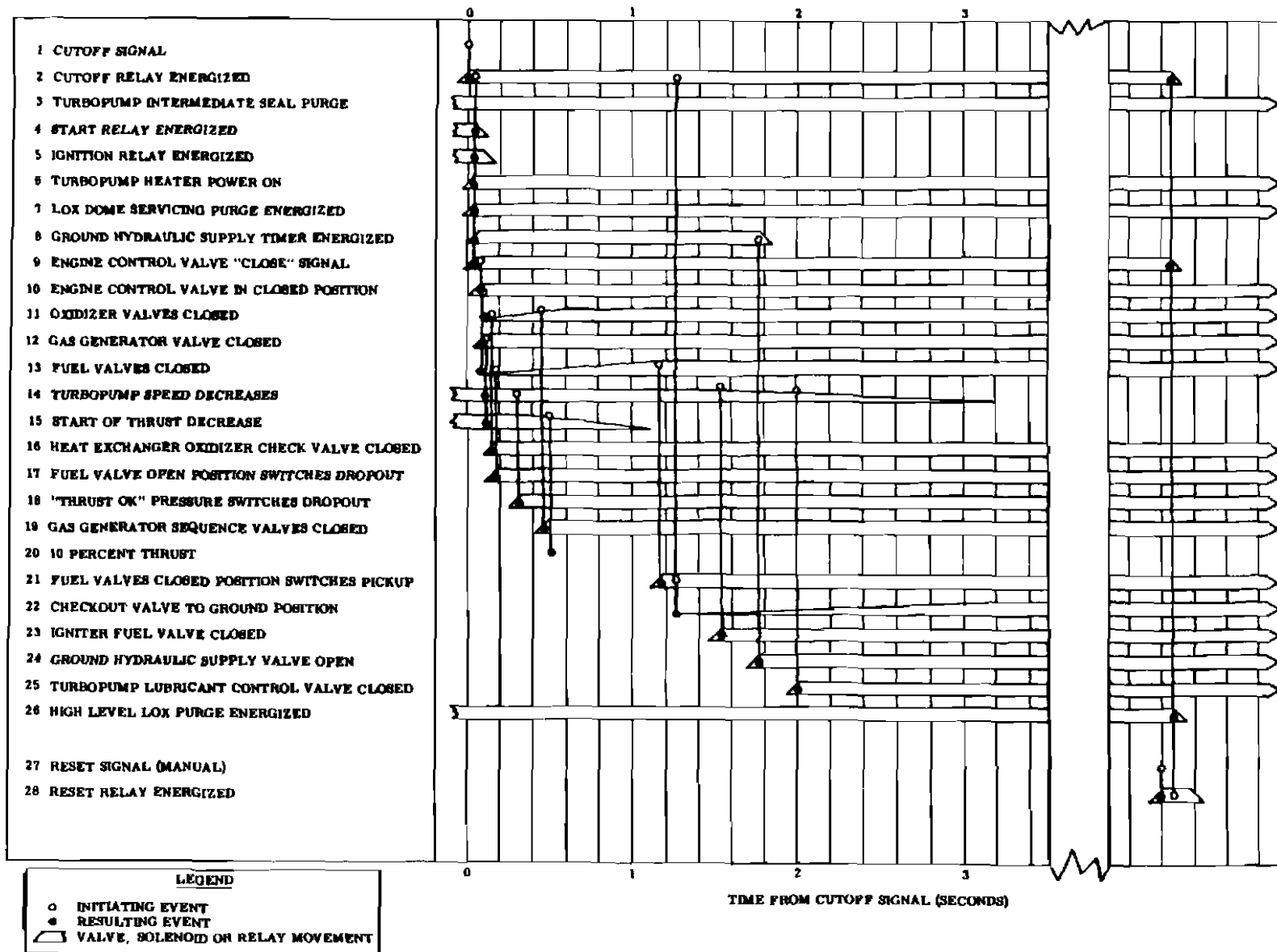

FI-1-37

Figure 3-28. Engine Cutoff Sequence Flow (Typical) (Engines Incorporating MD139 Change)

3-20. METHODS FOR PREDICTING ENGINE VARIABLE CHARACTERISTICS.

3-21. Methods for predicting engine variable characteristics include engine start time predictions, fuel pump impeller backcasing pressure re-orificing techniques, and methods of determining heat exchanger oxidizer and helium bypass orifice sizes.

3-22. ENGINE START TIME PREDICTIONS (REFERENCED TO ENGINE CONTROL VALVE OPENING SIGNAL AND BASED ON STAGE APPLICATION).

3-23. Three methods are presented to predict engine start time for any engine installed in the stage.

METHOD 1. This method may be used to predict the engine start time from engine control valve start signal to hypergol switch dropout if the engine has been operated under the following acceptance-test conditions and will be operated under the following conditions:

| | <u>Oxidizer Pump Inlet Pressure</u> | <u>Fuel Pump Inlet Pressure</u> |
|----------------------------|-------------------------------------|---------------------------------|
| Acceptance-Test Conditions | 112 ± 10 psig | 70 ± 10 psig |
| Stage Condition | 80 psia | 45 psia |

$$t_p = \left[-7.087 \times 10^{-2}(t) + 12.146 \times 10^{-5} (P_{IF})^2(t) - 4.2191 \times 10^{-6} (P_{I\phi})^2 + 0.14432 \right] (112 - P_{I\phi}) + \left[5.53068 \times 10^{-4} (P_{I\phi})(t) - 0.114259 \right] (70 - P_{IF}) + 2.105 t - 1.026$$

t_p = Predicted time from engine control valve start signal to hypergol switch dropout for stage test (seconds)

t = Acceptance test time from engine control valve start signal to hypergol switch dropout (seconds)

$P_{I\phi}$ = Pre-start oxidizer pump inlet pressure during acceptance test (psig)

P_{IF} = Pre-start fuel pump inlet pressure during acceptance test (psig)

METHOD 2. This method may be used to predict engine start time from engine control valve

start signal to hypergol switch dropout if the engine has been operated with any pre-start inlet pressures other than those specified in Method 1, and will be operated under the following stage conditions: (If this calculation is programmed, use "double precision" because of the high exponents involved.)

| | <u>Oxidizer Pump Inlet Pressure</u> | <u>Fuel Pump Inlet Pressure</u> |
|----------------------------|-------------------------------------|---------------------------------|
| Acceptance-Test Conditions | $P_{I\phi}$ | P_{IF} |
| Stage Conditions | 80 psia | 45 psia |

$$t_p = 3.5041(t) \left[\frac{1}{f(P_{I\phi}, P_{IF})} \right]$$

$$f(P_{I\phi}, P_{IF}) = K_1 (P_{I\phi}) + K_2 (P_{IF}) + K_3 + K_4 (P_{I\phi})^4 + K_5 (P_{I\phi})^5 + K_6 \left(\frac{P_{IF}}{P_{I\phi}} \right)^2 + K_7 \frac{(P_{IF})^2}{(P_{I\phi})^5} + K_8 \frac{(P_{IF} + 250)^2}{(P_{I\phi})^3}$$

$$K_1 = -0.34146221 \times 10^{-1}$$

$$K_2 = -0.34316603 \times 10^{-2}$$

$$K_3 = 0.48888479 \times 10$$

$$K_4 = 0.10864867 \times 10^{-7}$$

$$K_5 = -0.43755169 \times 10^{-10}$$

$$K_6 = 0.82104817$$

$$K_7 = -0.54861973 \times 10^5$$

$$K_8 = 0.26750823 \times 10$$

t_p = Predicted time from engine control valve start signal to hypergol switch dropout for stage test (seconds)

t = Acceptance test time from engine control valve start signal to hypergol switch dropout (seconds) at inlet conditions of $P_{I\phi}$ and P_{IF} (psig)

$P_{I\phi}$ = Pre-start oxidizer pump inlet pressure during acceptance test (psig)

P_{IF} = Pre-start fuel pump inlet pressure during acceptance test (psig)

f = Function of

METHOD 3. This method may be used to predict engine start time from engine control valve start signal to hypergol switch dropout if the engine will be operated at stage conditions other than an oxidizer pump inlet pressure of 80 psia and a fuel pump inlet pressure of 45 psia. (If this calculation is programmed, use "double precision" because of the high exponents involved.)

| | <u>Oxidizer Pump Inlet Pressure</u> | <u>Fuel Pump Inlet Pressure</u> |
|----------------------------|-------------------------------------|---------------------------------|
| Acceptance-Test Conditions | $P_{I\phi}$ | P_{IF} |
| Stage Conditions | \hat{P}_I | \hat{P}_{IF} |

a. Solve for a standardized time (\hat{t}) from engine control valve start signal to hypergol switch dropout using the following equations:

$$t = f(\hat{P}_{I\phi}, \hat{P}_{IF}) = K_1 (\hat{P}_{I\phi}) + K_2 (\hat{P}_{IF}) + K_3 + K_4 (\hat{P}_{I\phi})^4 + K_5 (P_{I\phi})^5 + K_6 \left(\frac{\hat{P}_{IF}^2}{P_{I\phi}} \right) + K_7 \frac{(\hat{P}_{IF})^2}{(P_{I\phi})^5} + K_8 \frac{(\hat{P}_{IF} + 250)^2}{(P_{I\phi})^3}$$

- $K_1 = -0.34146221 \times 10^{-1}$
- $K_2 = -0.34316603 \times 10^{-2}$
- $K_3 = 0.48888479 \times 10$
- $K_4 = 0.10864867 \times 10^{-7}$
- $K_5 = -0.43755169 \times 10^{-10}$
- $K_6 = 0.82104817$
- $K_7 = -0.54861973 \times 10^5$
- $K_8 = 0.26750823 \times 10$

- $\hat{P}_{I\phi}$ = Desired pre-start oxidizer pump inlet pressure (psig)
- P_{IF} = Desired pre-start fuel pump inlet pressure (psig)
- f = Function of

b. Solve for predicted time (t_p) from engine control valve start signal to hypergol switch dropout using the following equation:

$$t_p = \hat{t} \left[\frac{1}{f(P_{I\phi}, P_{IF})} \right]$$

$$f(P_{I\phi}, P_{IF}) = K_1 (P_{I\phi}) + K_2 (P_{IF}) + K_3 + K_4 (P_{I\phi})^4 + K_5 (P_{I\phi})^5 + K_6 \left(\frac{P_{IF}^2}{P_{I\phi}} \right) + K_7 \frac{(P_{IF})^2}{(P_{I\phi})^5} + K_8 \frac{(P_{IF} + 250)^2}{(P_{I\phi})^3}$$

- $K_1 = -0.34146221 \times 10^{-1}$
- $K_2 = -0.34316603 \times 10^{-2}$
- $K_3 = 0.48888479 \times 10$
- $K_4 = 0.10864867 \times 10^{-7}$
- $K_5 = -0.43755169 \times 10^{-10}$
- $K_6 = 0.82104817$
- $K_7 = -0.54861973 \times 10^5$
- $K_8 = 0.26750823 \times 10$

- t_p = Predicted time from engine control valve start signal to hypergol switch dropout for stage test (seconds)
- t = Acceptance test time from engine control valve start signal to hypergol switch dropout (seconds) at inlet conditions of $P_{I\phi}$ and P_{IF} (psig)
- \hat{t} = Standardized time from engine control valve start signal to hypergol switch dropout (seconds) calculated in step a
- $P_{I\phi}$ = Pre-start oxidizer pump inlet pressure during acceptance test (seconds)
- P_{IF} = Pre-start fuel pump inlet pressure during acceptance test (seconds)
- f = Function of

3-24. After the predicted time from engine control valve start signal to hypergol switch dropout has been calculated by Method 1, 2, or 3, the predicted stage time from engine control valve start signal to 90 percent (1,370K) of rated thrust may be calculated. In the stage, the predicted time from hypergol switch

dropout to 100 psig chamber pressure is 0.425 second.

Predicted time from engine control valve start signal to 90 percent thrust = $t_p + 1.100$ seconds

t_p = Predicted time from engine control valve start signal to hypergol switch dropout.

3-25. FUEL PUMP IMPELLER BACKCASING PRESSURE RE-ORIFICING TECHNIQUE.

3-26. RE-ORIFICING WITH NO CHANGE IN FUEL PUMP OPERATING CONDITIONS. If the fuel pump inlet pressures and speed are not to be changed between the latest test and the next test, use the following equation to re-orifice the balance cavity supply line to target for fuel impeller backcasing pressure of 250 psig:

$$D_2 = \sqrt{0.15634 - \frac{P_1}{1599} + D_1^2}$$

D_1 = Supply orifice diameter from latest test

P_1 = Fuel impeller backcasing pressure from latest test

D_2 = Supply orifice diameter to be used on next test

3-27. RE-ORIFICING WITH CHANGES IN FUEL PUMP INLET CONDITIONS. If the fuel pump inlet pressure for the next test is to be different from the fuel pump inlet pressure of the latest test, the fuel impeller backcasing pressure measured on the latest test should be projected to that which would have occurred if the test had been run under the new inlet pressure. This corrected pressure may then be used in the re-orifing procedure outlined in paragraph 3-25. Calculate the corrected fuel impeller backcasing pressure using the following equation:

$$P_{BCN} = P_{DFN} - \left[\frac{P_{DFL} - P_{BCL}}{P_{DFL} - P_{IFL}} \right]$$

$$\left(P_{DFN} - P_{IFN} \right)$$

P_{DFL} = Fuel discharge pressure observed on latest test

P_{IFL} = Fuel inlet pressure observed on latest test

P_{BCL} = Fuel impeller backcasing pressure observed on latest test

P_{DFN} = Fuel discharge pressure expected on next test

P_{IFN} = Fuel inlet pressure expected on next test

P_{BCN} = Fuel impeller backcasing pressure corrected for new inlet conditions

The new orifice diameter may then be calculated using the re-orifing equation (paragraph 3-26), with $P_{BCN} = P_1$.

3-28. RE-ORIFICING WITH CHANGES IN TURBOPUMP SPEED. If a significant change in turbopump speed (more than 40 rpm) is anticipated between the latest test and the next test, the fuel impeller backcasing pressure from the latest test must then be corrected to new turbopump speed before the re-orifing equation (paragraph 3-26) can be used. The present technique uses past component and engine turbopump fuel discharge pressures, fuel impeller backcasing pressures, fuel inlet pressures, and speed data for the specific turbopump being re-orifed. The fuel impeller backcasing pressure for each test should be corrected to the fuel pump inlet pressure expected on the next engine test, using the equation outlined in paragraph 3-27. This corrected fuel impeller backcasing pressure should be plotted against the turbopump speed observed during that test. The resulting curve determines the corrected fuel impeller backcasing pressure at the turbopump speed expected on the next test. The resulting value of fuel impeller backcasing pressure determines the new fuel impeller backcasing orifice diameter from the equation outlined in paragraph 3-26.

3-29. HEAT EXCHANGER PERFORMANCE EVALUATION AND PREDICTION.

3-30. Heat exchanger performance is determined from operational characteristics of the heat exchanger using data obtained during testing of the heat exchanger. The calculations

necessary to determine heat exchanger performance are made in a computer program, which requires data input as listed in figure 3-29. All listed input is required except for the LOX coil outlet pressure. Inclusion of the LOX coil outlet pressure will enable the LOX coil resistance to be calculated. Standardized data are included because they are required data; however, they normally are not changed from the nominal values listed in figure 3-29. Operating data should be obtained from a performance

data interval of 3.0 to 3.2 seconds duration that starts at or after 20 seconds of engine effective duration. Output from the program summarizes heat exchanger operation at site conditions, determines coil outlet temperatures at standard inlet conditions, predicts coil outlet temperatures at the target time of a subsequent test, and calculates the diameter of the coil bypass orifice required to achieve the target coil outlet temperature at standard inlet conditions and at the target time of a subsequent test.

| Type of Data | Parameter | | |
|---------------------------------------|--|---------------|---------|
| | Name | Nominal Value | Units |
| Identification Data | Engine serial number | | |
| | Heat exchanger serial number | | |
| | Test number | | |
| Test Condition Data | Test duration | | Seconds |
| | Ambient pressure | | psi |
| | Time of slice start | | Seconds |
| Operational Data | Turbine exhaust temperature | | ° F |
| | Sea-level turbine exhaust temperature | | ° F |
| | LOX coil flowrate | | lb/sec |
| | LOX coil inlet temperature | | ° F |
| | LOX coil outlet temperature | | ° F |
| | LOX coil outlet pressure (optional) | | psia |
| | Helium coil flowrate | | lb/sec |
| | Helium coil inlet temperature | | ° F |
| Standardized Data | Helium coil outlet temperature | | ° F |
| | Anticipated additional operation time to target time | 35 | Seconds |
| | LOX coil flowrate | 4 | lb/sec |
| | LOX coil inlet temperature | -288 | ° F |
| | LOX coil outlet target temperature | 470 | ° F |
| | Helium coil flowrate | 0.6 | lb/sec |
| | Helium coil inlet temperature | -345 | ° F |
| Helium coil outlet target temperature | 255 | ° F | |

Figure 3-29. Heat Exchanger Performance Evaluation and Prediction Input Data Requirements

3-31. HEAT EXCHANGER COMPUTER PROGRAM OPTIONS.

3-32. In addition to the performance evaluations and predictions (paragraph 3-30), the heat exchanger computer program contains the following optional capabilities:

a. Enables predictions to be based upon specified bypass ratios rather than bypass orifice diameters.

b. Enables heat exchanger performance to be predicted with specified alternate bypass orifice diameters.

c. Enables flowrates to be computed from flowmeter nozzle data.

d. Enables average performance to be established from a series of tests.

e. Enables coil outlet temperature data to be adjusted for instrumentation system lag when data is obtained during a transient condition.

3-33 through 3-37. (Deleted)

All data on pages 3-29 through 3-38, figures 3-30 through 3-38 deleted.

CALCULATED PARAMETERS

- R = Flowrate split ratio = $\frac{\text{coil flowrate}}{\text{total flowrate}}$
- U_{HEL} = Helium coil heat transfer coefficient on latest test--BTU/hr ft² °F
- U_{N} = Nitrogen heat transfer coefficient on latest test--BTU/hr ft² °F
- \hat{U}_{HEL} = Normalized helium coil heat transfer coefficient on latest test--BTU/hr ft² °F
- $N\hat{U}_{\text{HEL}}$ = Predicted normalized helium coil heat transfer coefficient for next test--BTU/hr ft² °F
- TIME = Equivalent accumulated time up to data interval on latest test--seconds
- N TIME = Equivalent total accumulated time at valid performance data interval for next test--seconds
- ND_{BP} = Predicted bypass orifice diameter for next test--inches

3-34. METHOD OF CALCULATING A NEW HELIUM-SIDE BYPASS ORIFICE DIAMETER. HELIUM FLOWED ON LATEST TEST AND FLOWRATE KNOWN (ENGINES F-2003 THROUGH F-2028).

a. Determine helium heat exchanger flowrate, W_{HEL} , from flow data on last test.

b. Calculate flowrate split ratio on latest from the following equation:

$$R = \frac{1.45 A_{\text{INT}}}{1.45 A_{\text{INT}} + A_{\text{BP}}}$$

c. Calculate helium-side heat transfer coefficient on latest test from the following equation:

$$U_{\text{HEL}} = \frac{R W_{\text{HEL}} C_P a_1}{A_X} \log_e \left\{ \frac{(T_{\text{TEM}} - T_{\text{HEL IN}})}{T_{\text{TEM}} - \left[\frac{T_{\text{HEL OUT}} + T_{\text{HEL IN}} \left(\frac{R-1}{R} \right)]}{R} \right]} \right\}$$

d. On figure 3-32, plot point U_{HEL} , W_{HEL} from values calculated in steps a and c. Normalize U_{HEL} to \hat{U}_{HEL} by moving parallel to H-lines to 0.6 lb/sec line. Read new U_{HEL} at 0.6 lb/sec line. \hat{U}_{HEL} is value of new U_{HEL} at 0.6 lb/sec line. If $\hat{U}_{\text{HEL}} > 160$ BTU/hr ft² °F, use $\hat{U}_{\text{HEL}} = 160$ BTU/hr ft² °F. If $\hat{U}_{\text{HEL}} < 55$ BTU/hr ft² °F, then $ND_{\text{BP}} = \text{zero}$.

e. From figure 3-33, find TIME for latest test, utilizing \hat{U}_{HEL} found in step d.

f. Calculate N TIME for next test, using the following equation:

$$N \text{ TIME} = \text{TIME} + \text{DUR} - \text{TOSS} - \alpha$$

g. Refer to figure 3-33 and using N TIME calculated in step f, find predicted normalized helium heat transfer coefficient, $N\hat{U}_{\text{HEL}}$, for next test. ($N\hat{U}_{\text{HEL}}$ is \hat{U}_{HEL} obtained from figure 3-33, using N TIME on TIME scale.)

h. From figure 3-34, using T_{TE} and $N\hat{U}_{\text{HEL}}$ obtained in step g, determine ND_{BP} to be installed for next test. If ND_{BP} does not differ from D_{BP} by more than 0.005 inch, no orifice change is necessary.

3-35. METHOD OF CALCULATING A NEW HELIUM-SIDE BYPASS ORIFICE DIAMETER. HELIUM FLOWED ON LATEST TEST AND FLOWRATE UNKNOWN (ENGINES F-2003 THROUGH F-2028).

a. Determine total effective duration of all tests on heat exchanger. Call this time t_A . For tests that had no flow on helium side of heat exchanger, duration relative to heat exchanger is 0.3 times test duration.

b. Calculate N TIME for the next test, using the following equation:

$$N \text{ TIME} = t_A + 60$$

c. From figure 3-33 and using N TIME calculated in step b, find predicted normalized helium heat transfer coefficient $N\hat{U}_{\text{HEL}}$ for next test. ($N\hat{U}_{\text{HEL}}$ is \hat{U}_{HEL} obtained from figure 3-33, using N TIME on TIME scale.) If $N\hat{U}_{\text{HEL}} > 120$ BTU/hr ft² °F, use $N\hat{U}_{\text{HEL}} = 120$ BTU/hr ft² °F. If $N\hat{U}_{\text{HEL}} < 55$ BTU/hr ft² °F, then $ND_{\text{BP}} = \text{zero}$.

d. From figure 3-34, using T_{TE} and \hat{N}_{HEL} obtained in step c, determine ND_{BP} to be installed for next test. If ND_{BP} does not vary from DBP by more than 0.005 inch, no orifice change is necessary.

3-36. METHOD OF CALCULATING A NEW HELIUM-SIDE BYPASS ORIFICE DIAMETER WHEN NITROGEN WAS USED INSTEAD OF HELIUM ON LATEST TEST (ENGINES F-2003 THROUGH F-2028).

a. Determine nitrogen heat exchanger flowrate, W_N from flow data on latest test.

b. Calculate flowrate split ratio on latest test from the following equation:

$$R = \frac{1.45 A_{INT}}{1.45 A_{INT} + A_{BP}}$$

c. Calculate nitrogen heat transfer coefficient on latest test from the following equation:

$$U_N = \frac{R W_N C_P a_1 \log_e \left(\frac{T_{TEM} - T_{N IN}}{T_{TEM} - \left[\frac{T_{N OUT}}{R} + T_{N IN} \left(\frac{R-1}{R} \right) \right]} \right)}{A_X}$$

d. From figure 3-35, find TIME for latest test.

e. Calculate cutoff time using the following equation:

$$CUTOFF TIME = TIME - DURATION - TOSS - a_2$$

f. Refer to figure 3-35 and using CUTOFF TIME calculated in step e, find U_{GN2} (cutoff slice).

g. Refer to figure 3-36 and obtain \hat{N}_{HEL} from U_{GN2} (cutoff slice).

h. From figure 3-34, using T_{TE} and \hat{N}_{HEL} obtained in step g, find ND_{BP} to be installed for next test. If ND_{BP} does not differ from DBP by more than 0.005 inch, no orifice change is necessary.

3-37. SAMPLE CALCULATION. The following is a sample calculation to determine a new helium-side bypass orifice diameter with

helium flowed on latest test, flowrate known, and the following parameters given:

- $W_{HEL} = 0.682 \text{ lb/sec}$
- $D_{BP} = 0.870 \text{ inch}$
- $A_{BP} = 0.594 \text{ in}^2$
- $T_{TEM} = 1,145^\circ \text{ F}$
- $T_{HEL IN} = -245^\circ \text{ F}$
- $T_{HEL OUT} = 169^\circ \text{ F}$
- $DUR = 150 \text{ seconds}$
- $TOSS = 35 \text{ seconds}$
- $T_{TE} = 1,100^\circ \text{ F}$

a. $W_{HEL} = 0.682 \text{ lb/sec}$

b.
$$R = \frac{1.45 A_{INT}}{1.45 A_{INT} + A_{BP}} = \frac{1.45 (0.251)}{1.45 (0.251) + 0.594} = 0.38$$

c.
$$U_{HEL} = \frac{R W_{HEL} C_P a_1 \log_e \left(\frac{T_{TEM} - T_{HEL IN}}{T_{TEM} - \left[\frac{T_{HEL OUT}}{R} + T_{HEL IN} \left(\frac{R-1}{R} \right) \right]} \right)}{A_X}$$

$$U_{HEL} = \frac{(0.38)(0.682)(1.24)(3,600) \log_e \left(\frac{(1,145 - (-245))}{1,145 - \left(\frac{169}{0.38} + (-245) \left(\frac{0.38-1}{0.38} \right) \right)} \right)}{19.6}$$

$$U_{HEL} = 59.1 \log_e 4.63$$

$$U_{HEL} = 90.5 \text{ BTU hr ft}^2 \text{ } ^\circ \text{F}$$

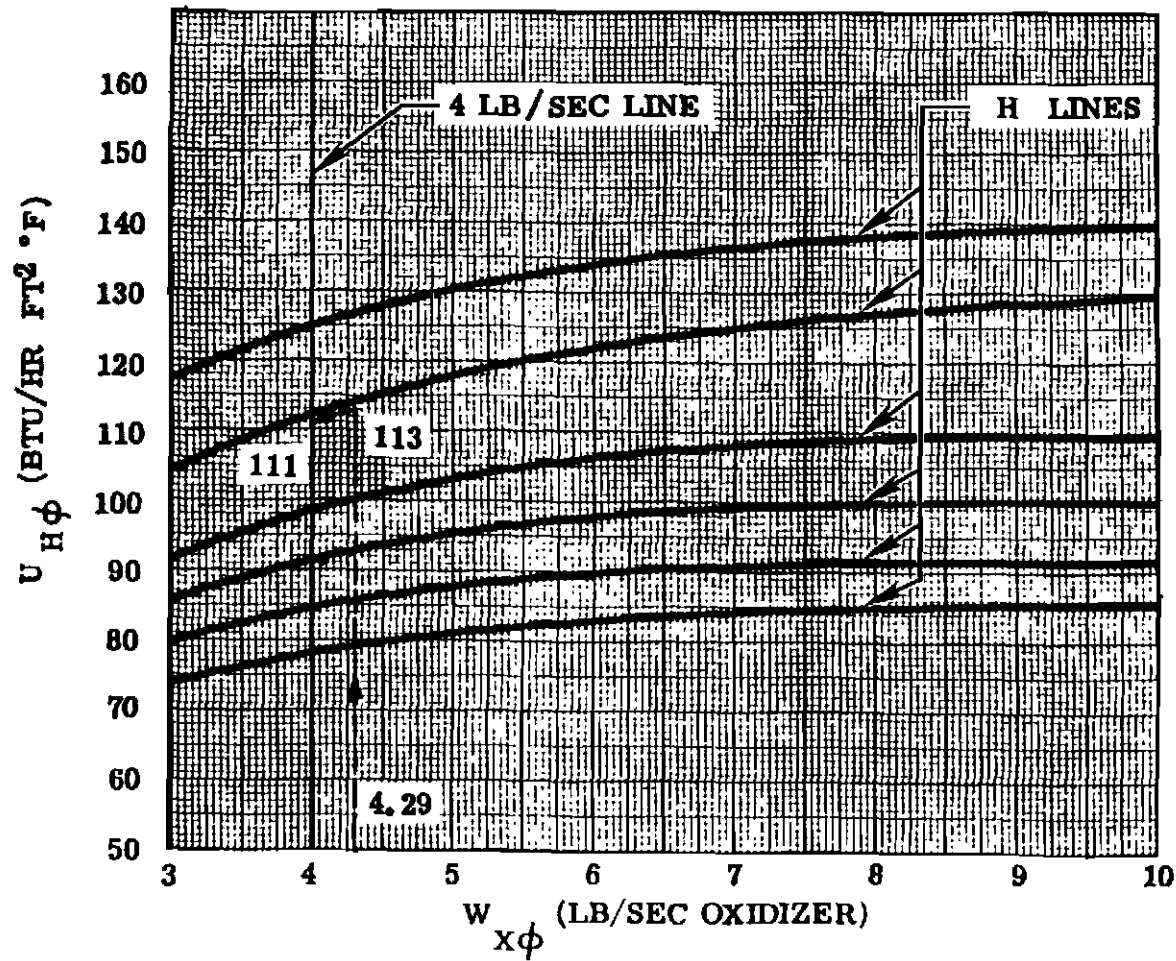

F1-1-6

Figure 3-29. Normalized Heat Transfer Coefficients for Nominal Oxidizer Flowrate (Oxidizer Side)

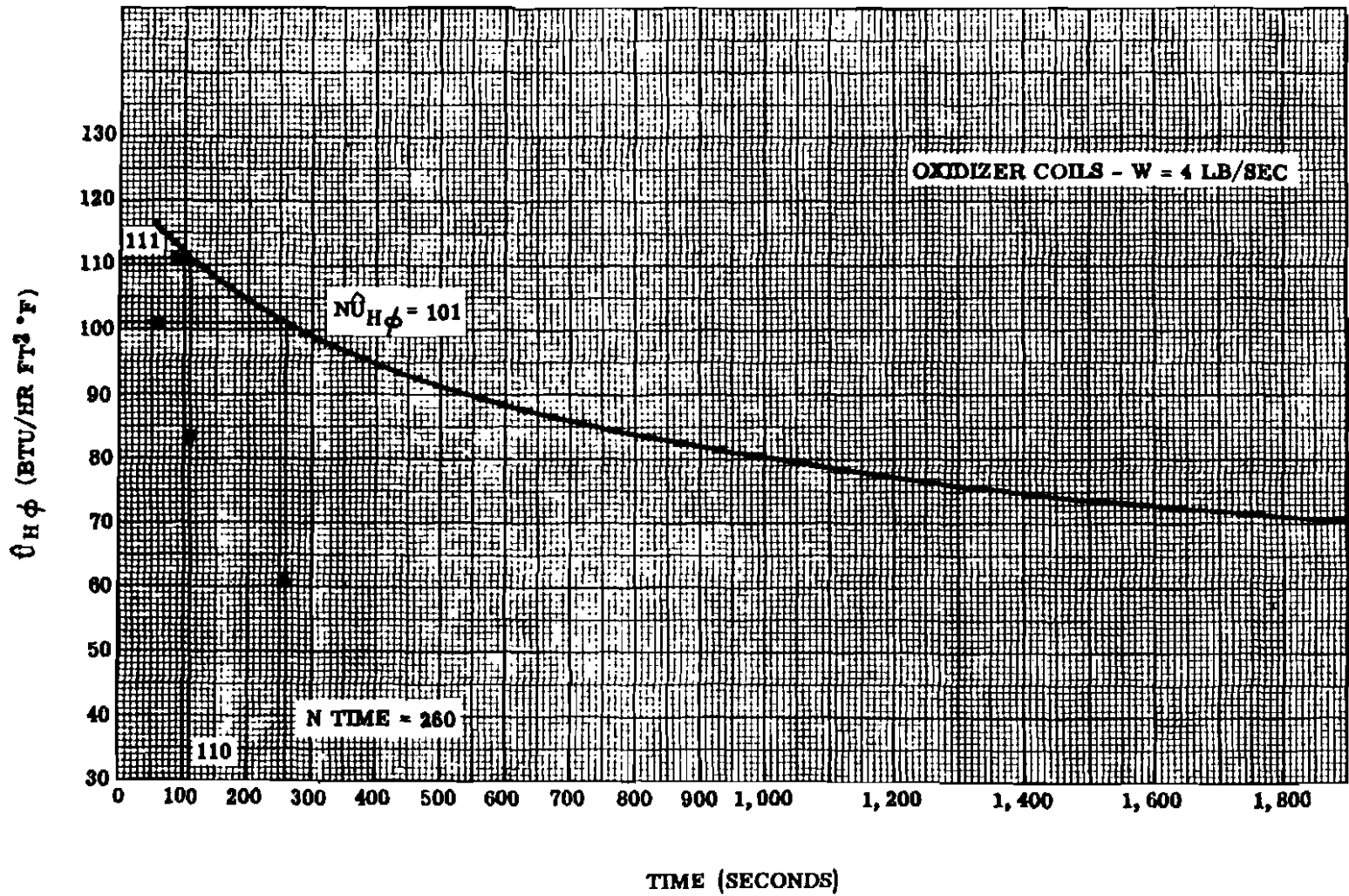

F1-1-7

Figure 3-30. Characteristic Normalized Heat Transfer Coefficient Versus Time (Oxidizer Side)

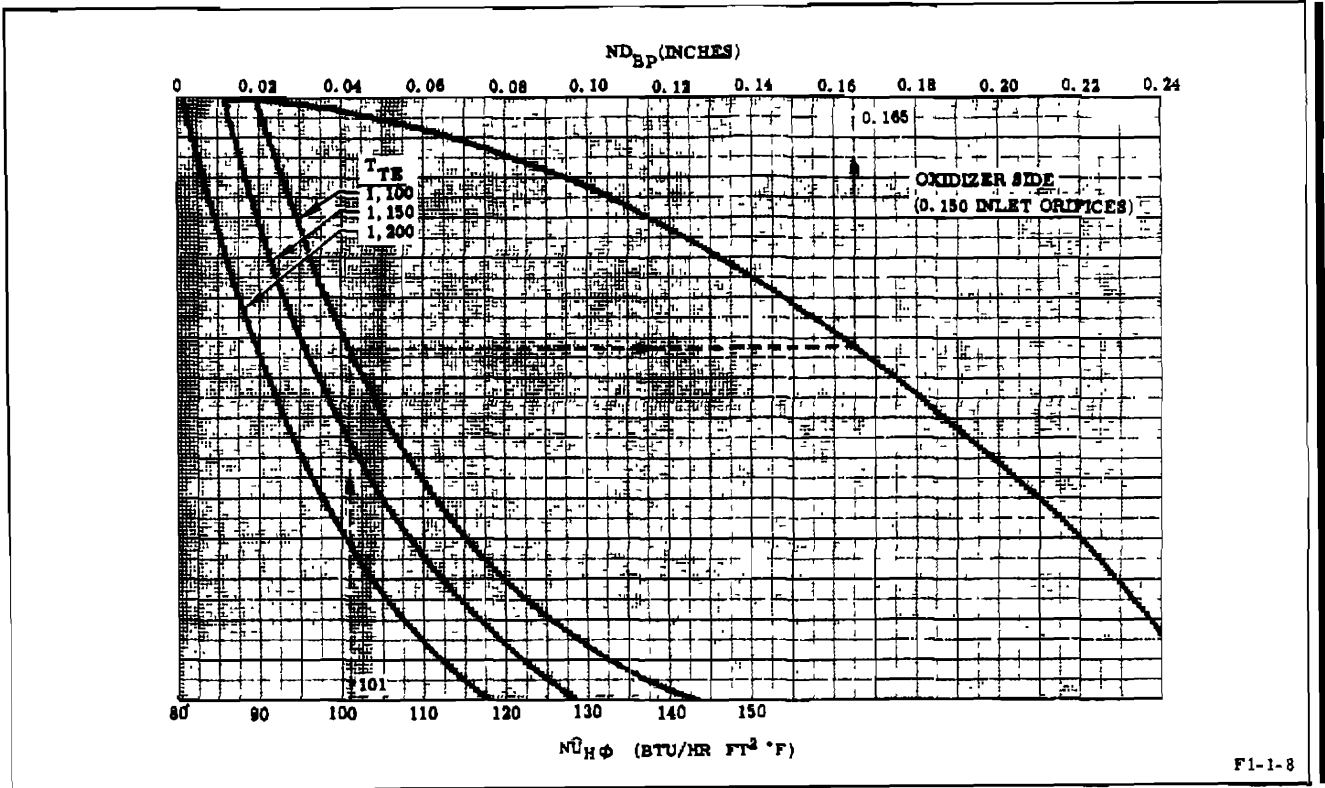
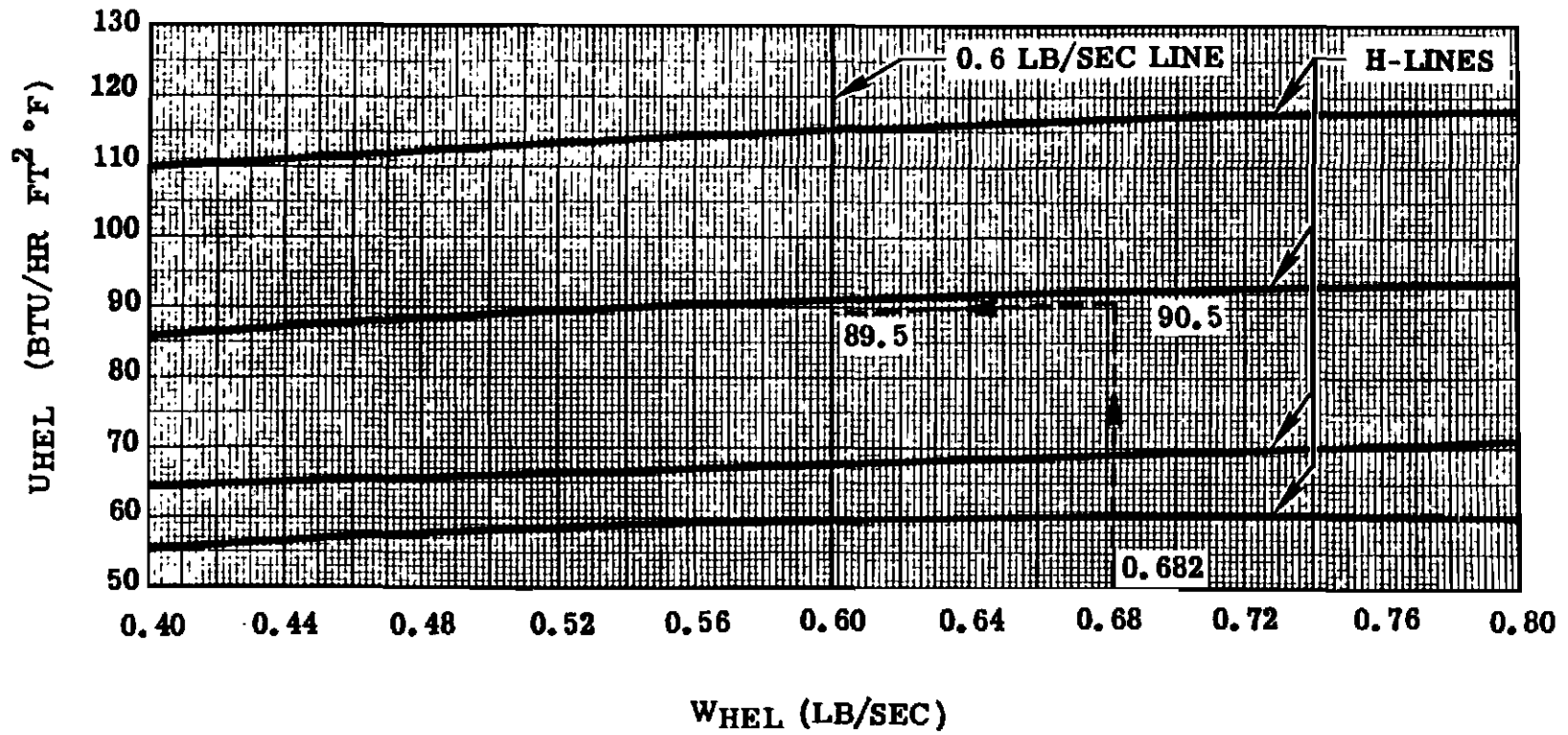

Figure 3-31. Monograph for Predicting Sea-Level Orifice Diameter (Oxidizer Side)



104001-G-50B

Figure 3-32. Normalized Heat Transfer Coefficient for Nominal Helium Flowrate (Helium Side)

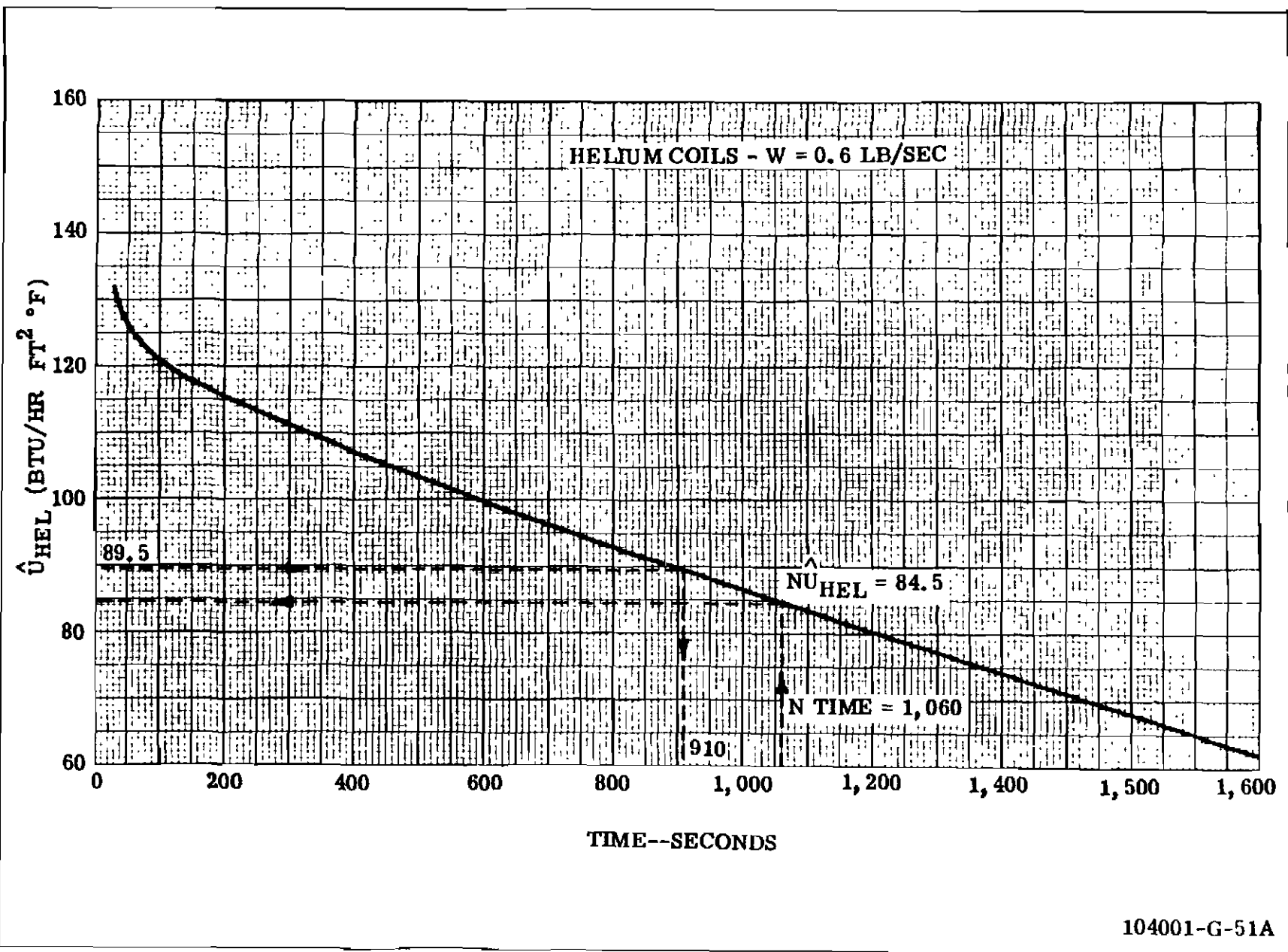
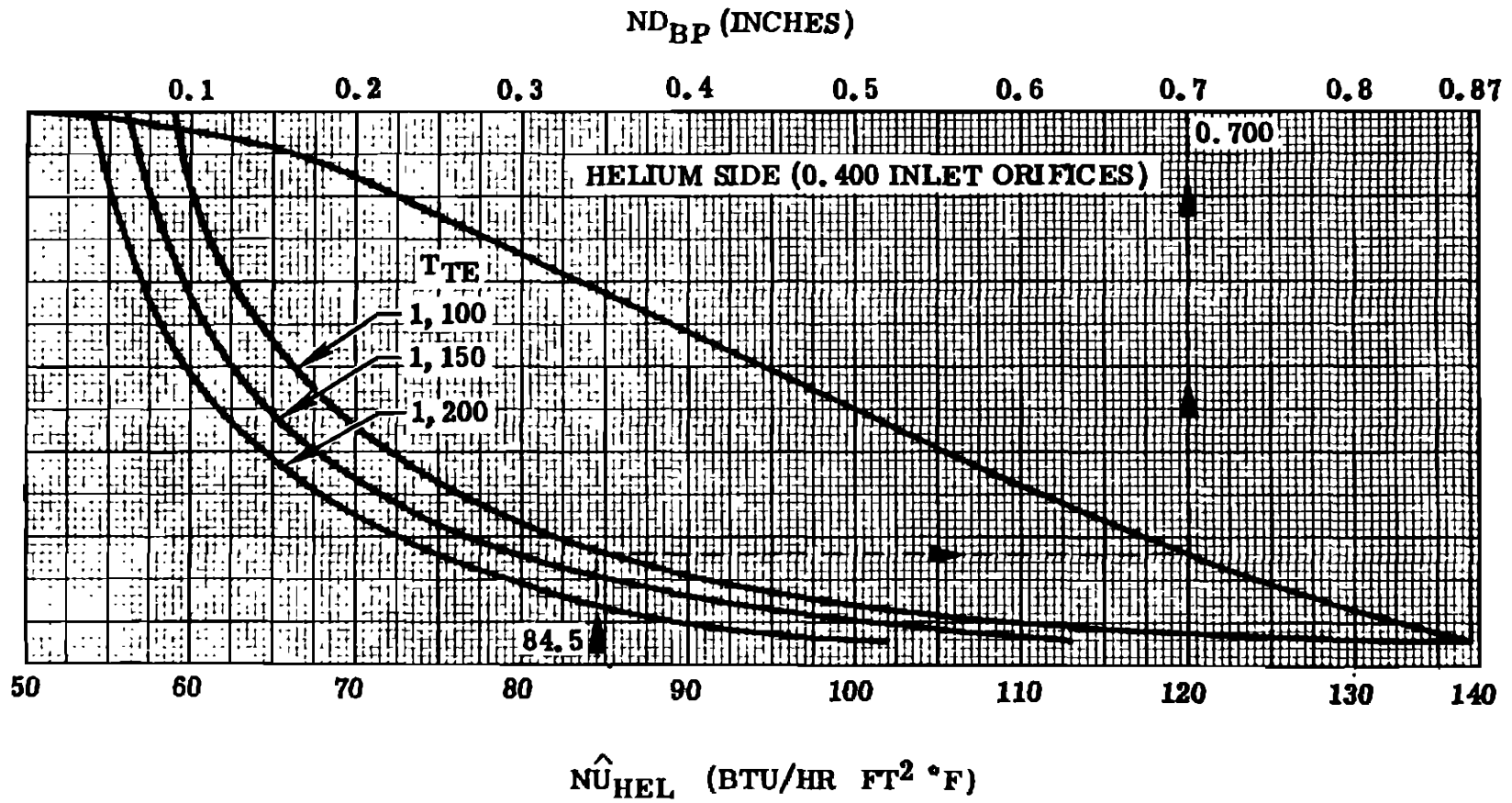

Figure 3-33. Characteristic Normalized Heat Transfer Coefficient Versus Time (Helium Side)



104001-G-52A

Figure 3-34. Monograph for Predicting Sea-Level Orifice Diameter (Helium Side)

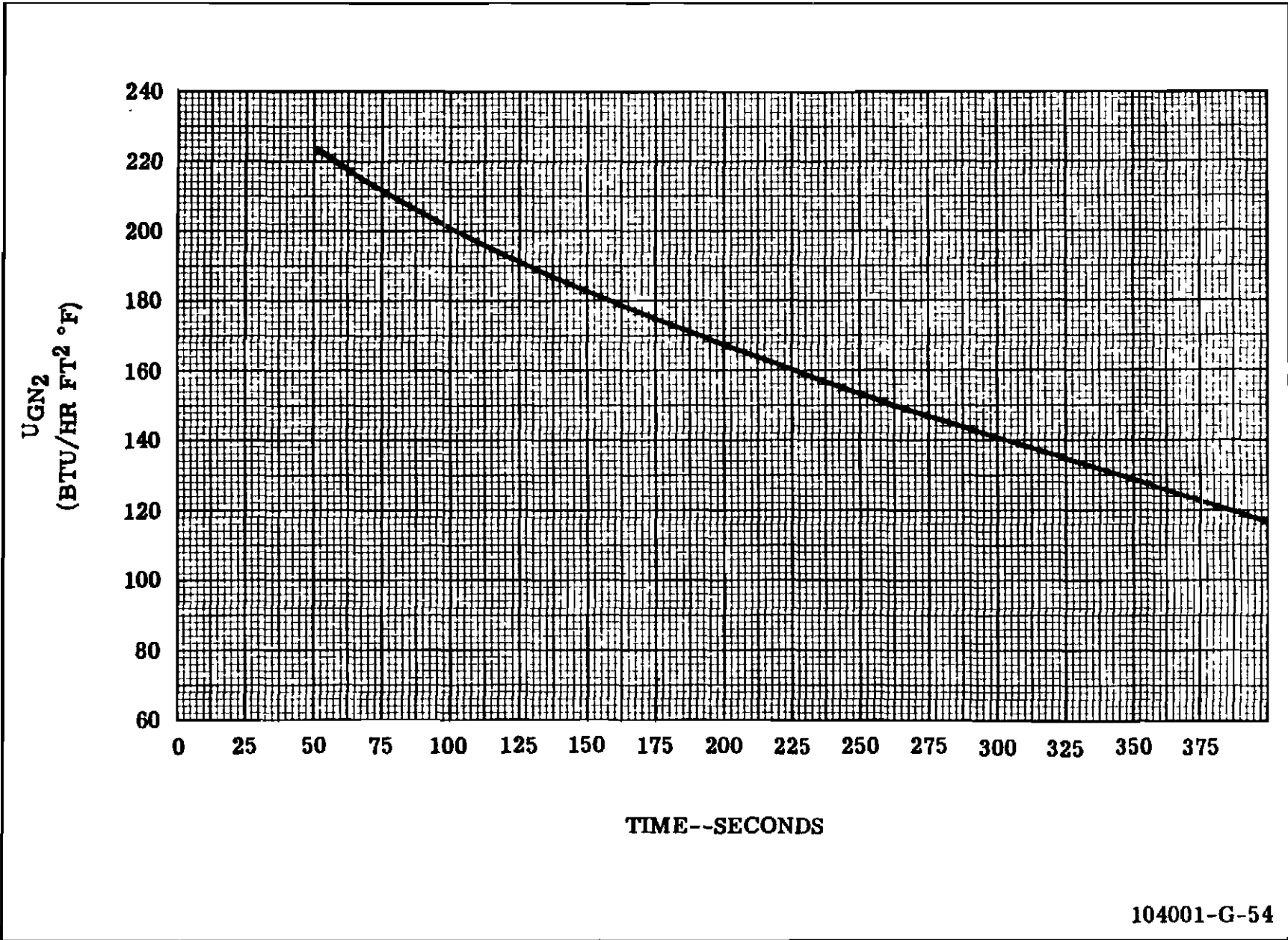

Figure 3-35. Characteristic Normalized Heat Transfer Coefficient Versus Time (GN₂ in Helium Coils)

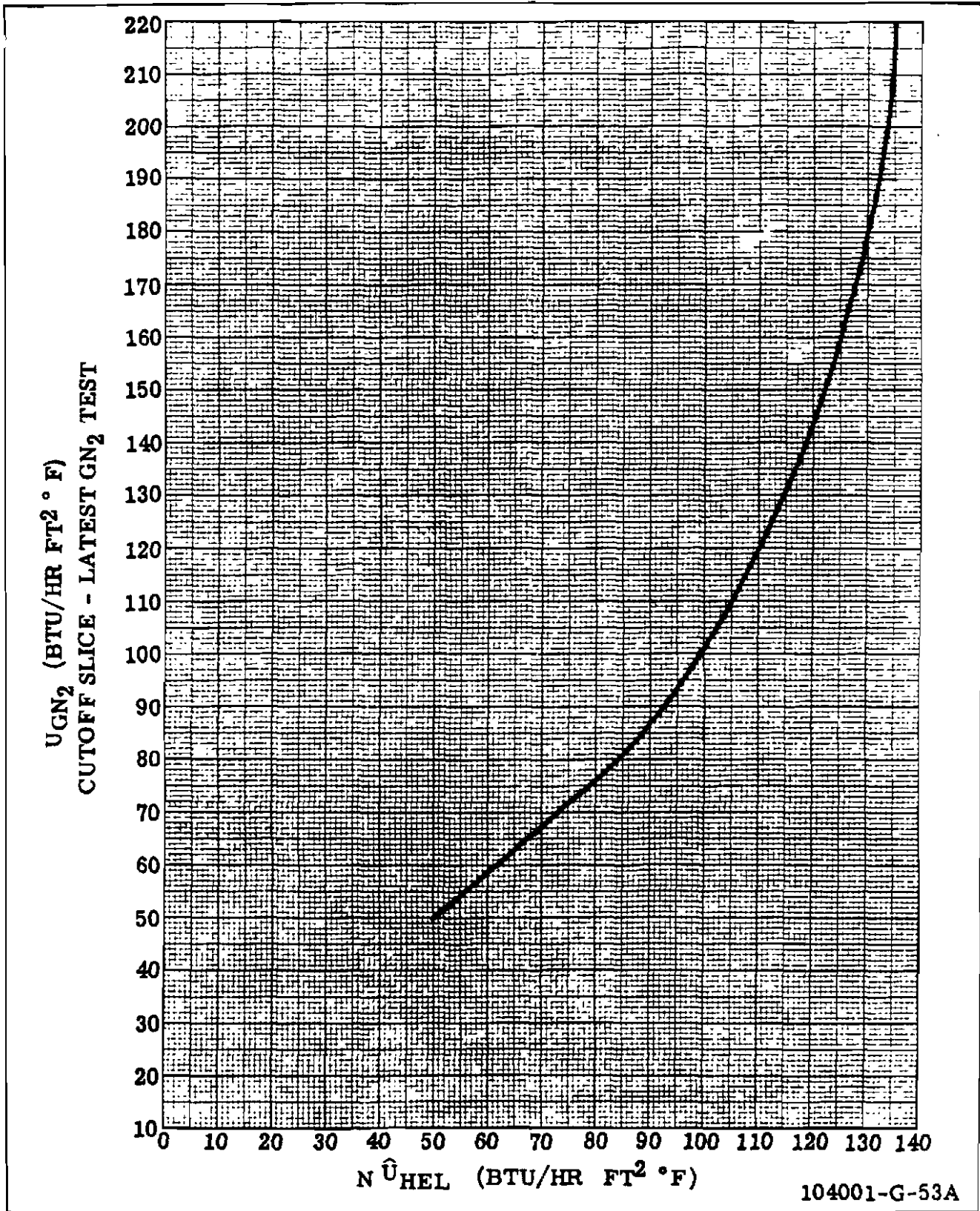

Figure 3-36. GN₂ Heat Transfer Coefficient Versus Helium Heat Transfer Coefficient

3-38. ENGINE INFLUENCE COEFFICIENTS.

3-39. Engine influence coefficients result from a linear solution of a set of steady-state equations which describe the operation of an engine. Each influence coefficient is expressed in percentage form and represents the effect upon an engine dependent variable of a plus-one-percent change in an engine independent variable. Because the influence coefficients are linear, the total effect of several influences acting simultaneously on an engine can be determined by adding the individual effects of each influence. A coefficient preceded by a positive (+) sign, or no sign, indicates that an increase in the independent variable results in an increase in the dependent variable; a coefficient preceded by a negative (-) sign indicates that an increase in the independent variable results in a decrease in the dependent variable. Figures 3-39 and 3-43 contain sets of the current predicted engine influence coefficients and, when calculations are required, these sets may be used. Paragraphs 3-39 through 3-43 describe the use of the engine influence coefficients using the formula

$$\frac{F_E - F_{E_i}}{F_{E_N}} = \frac{P_a - P_{a_i}}{P_{a_N}} (F_{P_a}) +$$

$$\frac{T_F - T_{F_i}}{T_{F_N}} (F_{T_F}) +$$

$$\frac{\rho_F - \rho_{F_i}}{\rho_{F_N}} (F_{\rho_F}) + \frac{\rho_O - \rho_{O_i}}{\rho_{O_N}} (F_{\rho_O}) +$$

$$\frac{P_F - P_{F_i}}{P_{F_N}} (F_{P_F}) + \frac{P_O - P_{O_i}}{P_{O_N}} (F_{P_O})$$

when the quantities are defined as follows:

NOTE

The values in g, k, and o are from the influence coefficient tables (figure 3-39).

a. F_E = Engine thrust--actual value

- b. F_{E_i} = Engine thrust--initial or base value
- c. F_{E_N} = Engine thrust--nominal value
- d. P_a = Ambient pressure--actual value
- e. P_{a_i} = Ambient pressure--initial or base value
- f. P_{a_N} = Ambient pressure--nominal value
- g. F_{P_a} = Ambient pressure--influence coefficient
- gA. T_F = Fuel temperature--actual value
- gB. T_{F_i} = Fuel temperature--initial or base value
- gC. T_{F_N} = Fuel temperature--nominal value
- gD. F_{T_F} = Fuel temperature--influence coefficient
- h. ρ_F and ρ_O = Fuel (F) and Oxidizer (O) density--actual value
- i. ρ_{F_i} and ρ_{O_i} = Fuel (F) and Oxidizer (O) density--initial or base value
- j. ρ_{F_N} and ρ_{O_N} = Fuel (F) and Oxidizer (O) density--nominal value
- k. F_{ρ_F} and F_{ρ_O} = Fuel (F) and Oxidizer (O) density--influence coefficient value
- l. P_F and P_O = Fuel (F) and Oxidizer (O) pump inlet pressure--actual value
- m. P_{F_i} and P_{O_i} = Fuel (F) and Oxidizer (O) pump inlet pressure--initial or base value
- n. P_{F_N} and P_{O_N} = Fuel (F) and Oxidizer (O) pump inlet pressure--nominal value
- o. F_{P_F} and F_{P_O} = Fuel (F) and Oxidizer (O) pump inlet pressure--influence coefficient value

A ONE PERCENT INCREASE IN ANY ONE OF THE INDEPENDENT VARIABLES CAUSES THE FOLLOWING PERCENTAGE CHANGE IN ANY ONE OF THE DEPENDENT VARIABLES

| -INDEPENDENT VARIABLES- | | | | | | | | | | | | |
|---------------------------------|-------------|------------------------------------|-------------|------------------------------|-------------|--|--|--|--|--|--|--|
| 1- ATMOSPHERIC PRES | 0.14696E 02 | 8- OXIDE PUMP INLET PRES | 0.65000E 02 | 11- TURBINE NOZZLE AREA | 0.17000E 02 | | | | | | | |
| 2- FUEL DENSITY (CONSTANT TEMP) | 0.50450E 02 | 7- C* CORRECTION | 0.10000E 01 | 12- TURBINE EFFICIENCY RATIO | 0.10000E 01 | | | | | | | |
| 3- FUEL TEMP (CONSTANT DENSITY) | 0.60000E 02 | 8- ACCELERATION | 0.10000E 01 | | | | | | | | | |
| 4- OXIDIZER DENSITY | 0.71380E 02 | 9- MAIN FUEL ORIFICE RESISTANCE | 0.34053E 02 | | | | | | | | | |
| 5- FUEL PUMP INLET PRES | 0.45000E 02 | 10- GG OXIDIZER ORIFICE RESISTANCE | 0.80234E 01 | | | | | | | | | |

| -DEPENDENT VARIABLES- | | | | | | | | | | | | |
|------------------------------|-------------|---------|---------|---------|---------|---------|---------|---------|---------|---------|---------|--------|
| | 1- | 2- | 3- | 4- | 5- | 6 | 7- | 8- | 9- | 10- | 11- | 12- |
| ENGINE THRUST | 0.15220E 07 | | | | | | | | | | | |
| | -0.1459 | -0.9434 | 0.0191 | 2.1345 | -0.0090 | 0.0544 | 1.1319 | 0.0014 | -0.0288 | -0.2741 | 0.0972 | 1.1725 |
| ENGINE SPECIFIC IMPULSE | 0.28536E 03 | | | | | | | | | | | |
| | -0.1458 | -0.1427 | 0.0028 | 0.3103 | -0.0014 | 0.0079 | 1.1470 | 0.0002 | -0.0059 | -0.0395 | 0.0042 | 0.1669 |
| ENGINE MIXTURE RATIO | 0.22701E 01 | | | | | | | | | | | |
| | -0.0000 | -1.5589 | -0.0067 | 1.5469 | -0.0217 | 0.0348 | -0.0607 | 0.0007 | 0.0807 | -0.0094 | -0.0089 | 0.0225 |
| ENGINE FUEL FLOW | 0.17537E 04 | | | | | | | | | | | |
| | 0.0 | 0.2815 | 0.0209 | 0.7503 | 0.0074 | 0.0223 | 0.0270 | 0.0007 | -0.0788 | -0.2281 | 0.0992 | 0.9900 |
| ENGINE OXIDIZER FLOW | 0.39612E 04 | | | | | | | | | | | |
| | -0.0000 | -1.2774 | 0.0142 | 2.2972 | -0.0143 | 0.0571 | -0.0338 | 0.0014 | 0.0019 | -0.2375 | 0.0902 | 1.0124 |
| TC INJECTOR END PRESSURE | 0.11227E 04 | | | | | | | | | | | |
| | 0.0000 | -0.7232 | 0.0171 | 1.8718 | -0.0065 | 0.0452 | 0.9889 | 0.0011 | -0.0305 | -0.2387 | 0.0843 | 1.0204 |
| TC C* ACTUAL | 0.54464E 04 | | | | | | | | | | | |
| | 0.0000 | 0.1029 | 0.0007 | -0.0879 | -0.0015 | -0.0019 | 1.0185 | -0.0000 | -0.0088 | -0.0031 | 0.0007 | 0.0124 |
| GIMBAL SUPPLY PRESSURE | 0.18260E 04 | | | | | | | | | | | |
| | -0.0000 | -0.6190 | 0.0289 | 1.6679 | 0.0017 | 0.0451 | 0.6101 | 0.0012 | 0.0135 | -0.3271 | 0.1132 | 1.3934 |
| GG FUEL FLOW | 0.12058E 03 | | | | | | | | | | | |
| | 0.0000 | 0.3877 | 0.0183 | 0.6319 | 0.0074 | 0.0203 | 0.3555 | 0.0007 | 0.0194 | -0.1464 | 0.3648 | 0.9301 |
| GG OXIDIZER FLOW | 0.50189E 02 | | | | | | | | | | | |
| | 0.0000 | -0.8480 | 0.0067 | 1.8511 | -0.0086 | 0.0450 | 0.4620 | 0.0013 | -0.0130 | -0.3316 | 0.4805 | 0.9189 |
| TURBINE SPEED | 0.54884E 04 | | | | | | | | | | | |
| | -0.0000 | -0.8006 | 0.0115 | 0.8370 | -0.0085 | 0.0230 | 0.2638 | 0.0007 | -0.0077 | -0.1780 | 0.0647 | 0.7609 |
| TURBINE EXIT STATIC PRES | 0.57121E 02 | | | | | | | | | | | |
| | 0.0000 | -0.8500 | 0.0213 | 1.8941 | -0.0061 | 0.0419 | 0.4510 | 0.0012 | -0.0081 | -0.3073 | 0.4725 | 0.8174 |
| EXHAUST NOZZLE TOTAL PRES | 0.48056E 02 | | | | | | | | | | | |
| | -0.0000 | -0.5132 | 0.0197 | 1.5515 | 0.0043 | 0.0389 | 0.4354 | 0.0012 | -0.0046 | -0.2853 | 0.4841 | 0.8118 |
| TURBINE MANIFOLD TEMPERATURE | 0.15600E 04 | | | | | | | | | | | |
| | 0.0000 | -2.8169 | 0.0328 | 2.9374 | -0.0362 | 0.0609 | 0.3019 | 0.0016 | 0.0724 | -0.4540 | 0.1738 | 0.1155 |

Figure 3-39. Engine Influence Coefficients (Predicted) (Engines F-2029 through F-2066)

3-40. CALCULATIONS INVOLVING A TYPICAL ENGINE.

3-41. For calculations involving a typical engine, the initial values would be the same as the nominal values, as follows:

$$\begin{aligned} F_{E_i} &= F_{E_N} & P_{a_i} &= P_{a_N} & T_{F_i} &= T_{F_N} \\ \rho_{F_i} &= \rho_{F_N} & \rho_{O_i} &= \rho_{O_N} \\ P_{F_i} &= P_{F_N} & P_{O_i} &= P_{O_N} \end{aligned}$$

The following are the calculations used to determine the thrust of the engine when operated under the following conditions:

- Atmospheric pressure = 3.90 psia
- Fuel temperature = 75° F
- Fuel density = 50.45 lb/cuft
- Oxidizer density = 70.90 lb/cuft
- Fuel pump inlet pressure = 42.00 psia
- Oxidizer pump inlet pressure = 89.55

$$\begin{aligned} \frac{F_E - 1,522,000}{1,522,000} &= \frac{3.90 - 14.696}{14.696} (-0.1458) + \\ &\quad \left(\frac{75.00 - 60.00}{60.00} \right) (0.0191) + \\ &\quad \left(\frac{50.45 - 50.45}{50.45} \right) (-0.9434) + \\ &\quad \left(\frac{70.90 - 71.38}{71.38} \right) (2.1345) + \\ &\quad \left(\frac{42.00 - 45.00}{45.00} \right) (-0.0090) - \\ &\quad \left(\frac{89.55 - 65.00}{65.00} \right) (0.0544) \end{aligned}$$

$$\begin{aligned} \frac{F_E - 1,522,000}{1,522,000} &= (-0.7346) (-0.1458) + \\ &\quad (0.2500) (0.0191) + \\ &\quad (0.0) (-0.9434) + \\ &\quad (-0.0067) (2.1345) + \\ &\quad (-0.0667) (0.0090) + \\ &\quad (0.3777) (0.0544) \\ &= +0.1187 \text{ or } +11.87 \text{ percent} \\ &\quad \text{change} \end{aligned}$$

$$\begin{aligned} F_E &= +0.1187 (1,522,000) + 1,522,000 \\ &= +180,700 + 1,522,000 = 1,702,700 \end{aligned}$$

The incremental thrust has been found to be 180,700 lb for the conditions stated, yielding a final engine thrust of 1,702,700 lb. Propellant densities may be estimated from measured temperature and pressure data with the aid of figures 3-40 and 3-41. Figure 3-40 presents the relationship between the temperature and density for a nominal cut of RP-1 fuel. When the density of a batch of RP-1 is known at one temperature, the density at another temperature can be determined with the slope of the nominal RP-1 line shown in figure 3-40. The effect of pressure on the density of RP-1 is small and may be ignored for inlet conditions encountered on the engine. Figure 3-41 presents the relationship between liquid oxygen temperature, pressure, and density. Two density-versus-temperature curves are presented to show the effect of varying inlet pressure on oxygen density.

3-42. CALCULATIONS INVOLVING A SPECIFIC ENGINE.

3-43. When the values of actual engine parameters differ from those used as nominal values in the table of influence coefficients, the "delta method" of application of influence coefficients is used. This procedure consists of computing an incremental change of variables rather than a percentage change of these variables. The incremental change is then applied to the actual engine value. This effect can be accomplished by using the equation of the quantities

$$F_{E_i}, P_{a_i}, F_i, \rho_{O_i}, P_{F_i}, \text{ and } P_{O_i}$$

which are defined as the actual engine values of these parameters. All other quantities are as defined previously.

3-43A. TEST TREND CORRECTIONS.

3-43B. During a test, the engine exhibits characteristic trends that may be predicted with the use of influence coefficients. Nominal and actual performance values are established during a time interval of 35-38 seconds of burn time. Changes occur in turbine operational characteristics resulting from coke deposits on internal turbine assembly. Performance changes are calculated for burn time using figures 3-41A and 3-41B for engines F-2029 through F-2065 and figures 3-44 and 3-44A for engines F-2066 and subsequent. Figures 3-41A and 3-44 present the percentage change in turbine nozzle area as a

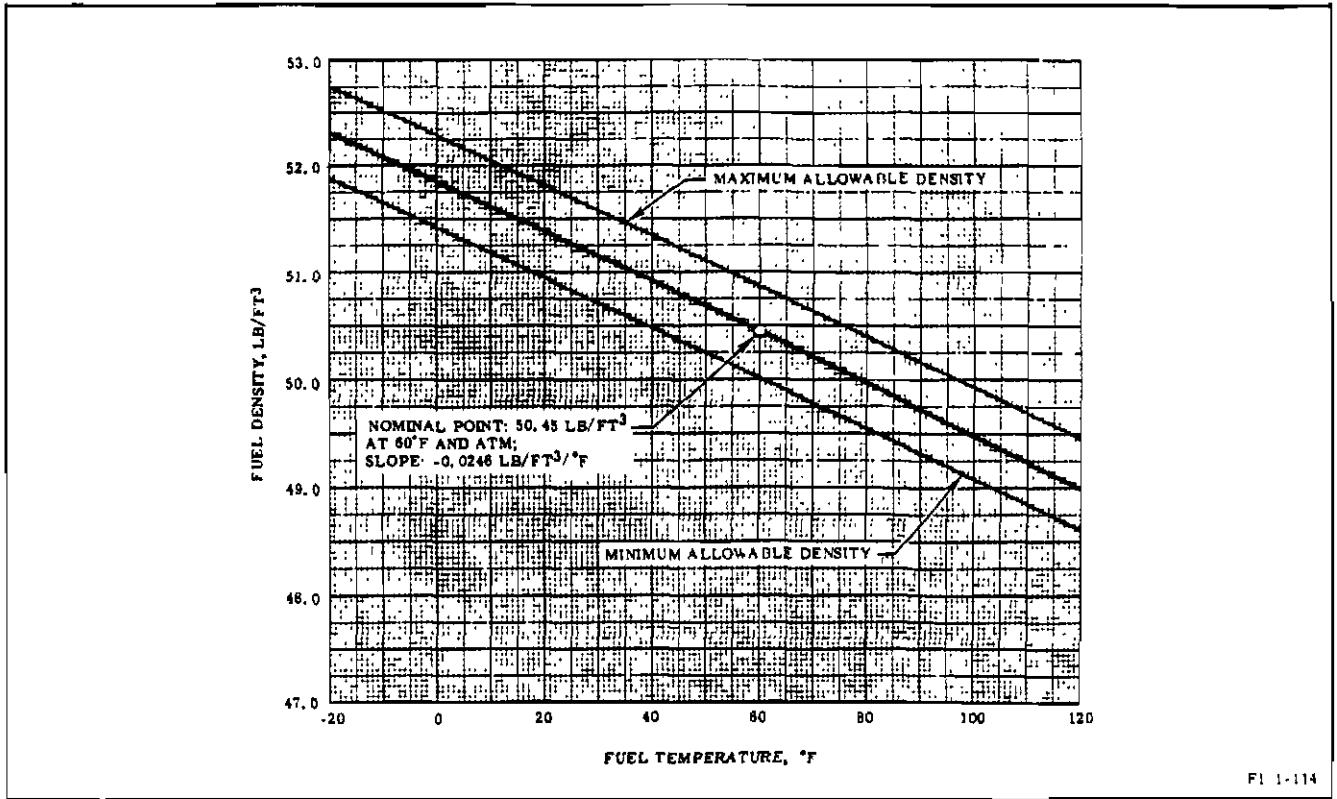

Figure 3-40. RP-1 Fuel Density Versus Temperature

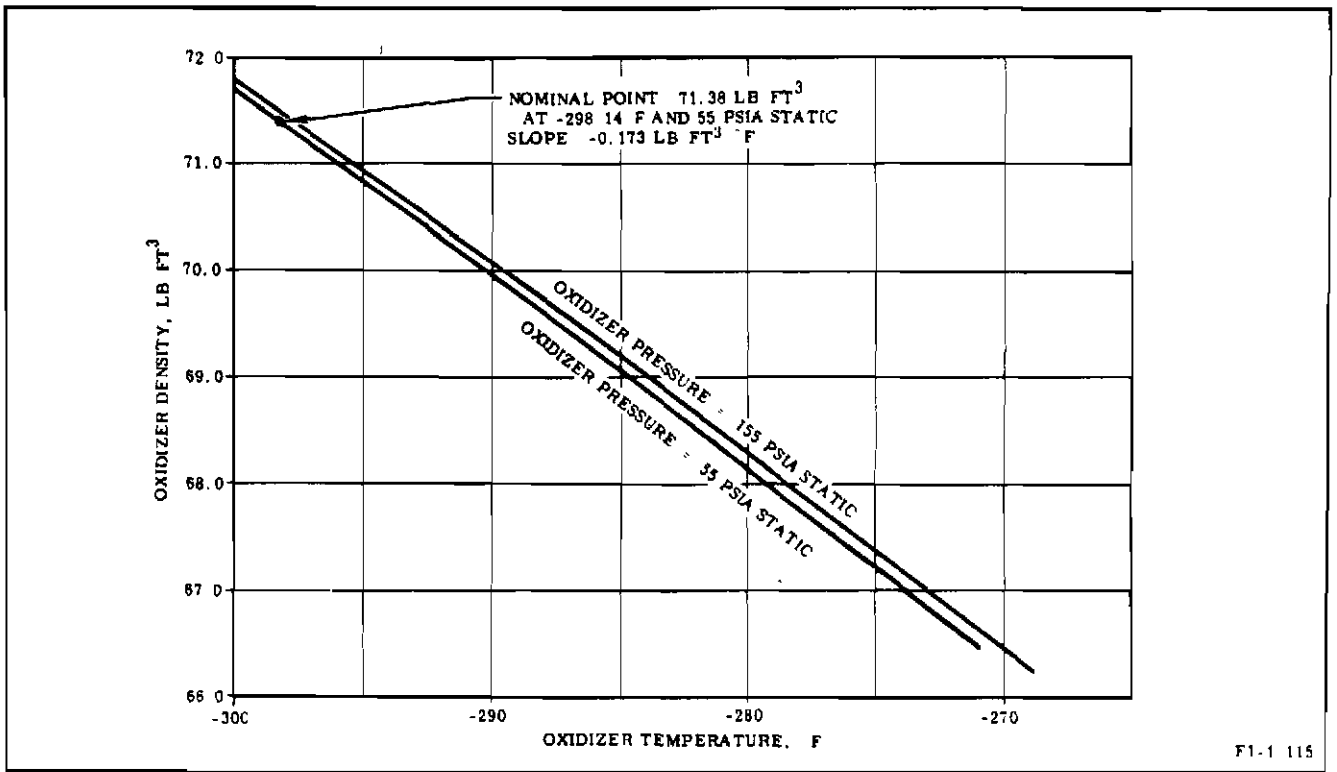

Figure 3-41. Oxidizer Density Versus Temperature

function of burn time, and figures 3-41B and 3-44A present the percentage change in turbine efficiency ratio as a function of burn time. Performance parameters for burn time are adjusted by obtaining the percentage changes expected at the burn time of interest. These percentage changes and the parameter influence coefficients are then multiplied to determine the net percentage change in the performance parameter of interest. In the following example, the thrust of the engine operated under the conditions specified in paragraph 3-41A is adjusted to a 90-second burn time. In figure 3-41A the percentage change in turbine nozzle area at 90 seconds is -3.0 percent. In figure 3-41B the percentage change in turbine efficiency ratio at 90 seconds is -0.25 percent. Therefore, using influence coefficients (figure 3-39),

$$\frac{F_E - 1,702,700}{1,522,000} = \begin{matrix} (-0.0300) (0.0972) \\ (-0.0025) (1.1725) \end{matrix} + \\ = -0.00585$$

$$F_E = (-0.00585) (1,522,000) + 1,702,700 \\ = -8,904 + 1,702,700 \\ = 1,693,796 \text{ lb}$$

- Figures 3-41C and 3-44B present thrust differential (based on a predicted performance value from a data slice between 35 and 38 seconds flight time at sea-level and turbopump inlet standard conditions) versus burn time when the performance values are adjusted using influence coefficients from column 11 and 12 of figures 3-39 or 3-43 and turbine nozzle area and turbine efficiency ratio changes from figures 3-41A and 3-41B or 3-44 and 3-44A.

3-44. NONLINEAR CORRECTIONS

- 3-45. A special computational procedure has been devised to extend the usefulness of engine influence coefficient. This technique is used to allow nonlinear corrections to be made for parameters where the linear approximation is not sufficiently accurate. An example of this method is the C* (characteristic velocity) correction. In this case, a plot of C* correction versus the change in engine mixture ratio is included in addition to the table of influence coefficients. A plot of these parameters for the engine is shown in figures 3-42 and 3-44C. The change in engine mixture ratio is computed for the changes in atmospheric pressure, propellant densities, etc, and with the assumption that the C*

correction is zero. With this change in engine mixture ratio, the C* correction is read from the curve. This value of C* correction is used with the other independent variables to recompute the engine mixture ratio, which yields a new value of C* correction. The mixture ratio is then recomputed using the last value of C* correction. This iterative process is continued until the computed mixture ratio ceases to change between two iterations. The corresponding value of C* correction is then used with the other independent variables to compute the changes in the remaining dependent variables. For example, if the final iteration change in engine mixture ratio accompanying the 11.87-percent thrust change in the preceding example were -5 percent, then the C* correction from figure 3-42 is 0.10 percent. Therefore, the true change in engine thrust is $F_E = 11.87 + 1,1319 (-0.10) = +11.76$ percent.

3-46. COMPONENT REPLACEMENT EFFECTS ON ENGINE PERFORMANCE AT SEA LEVEL.

3-47. Component replacement effects on engine performance at sea level are in R-3896-11. The deviations presented are the maximum expected effects on sea-level engine thrust, mixture ratio, and specific impulse when the listed components are replaced, and are applicable to engines as noted. The following procedure is to be used for determining the maximum expected performance deviations for individual engines.

a. The deviations listed in R-3896-11, corresponding to hardware replaced on the engine, are to be tabulated and included with the Engine Log Book. This tabulation is necessary for future reference and continuous updating when additional replacements are made.

b. The combination of deviations due to the replacement of each individual component determines the expected maximum performance deviation. The combination is accomplished by calculating the square root of the sum of the squares of the deviations listed in R-3896-11, corresponding to each component-replaced. Components replaced a second time are treated as a single replacement of the item. (No additional variation is added besides the variation for the component being replaced a second time.) An example is shown in figure 3-45.

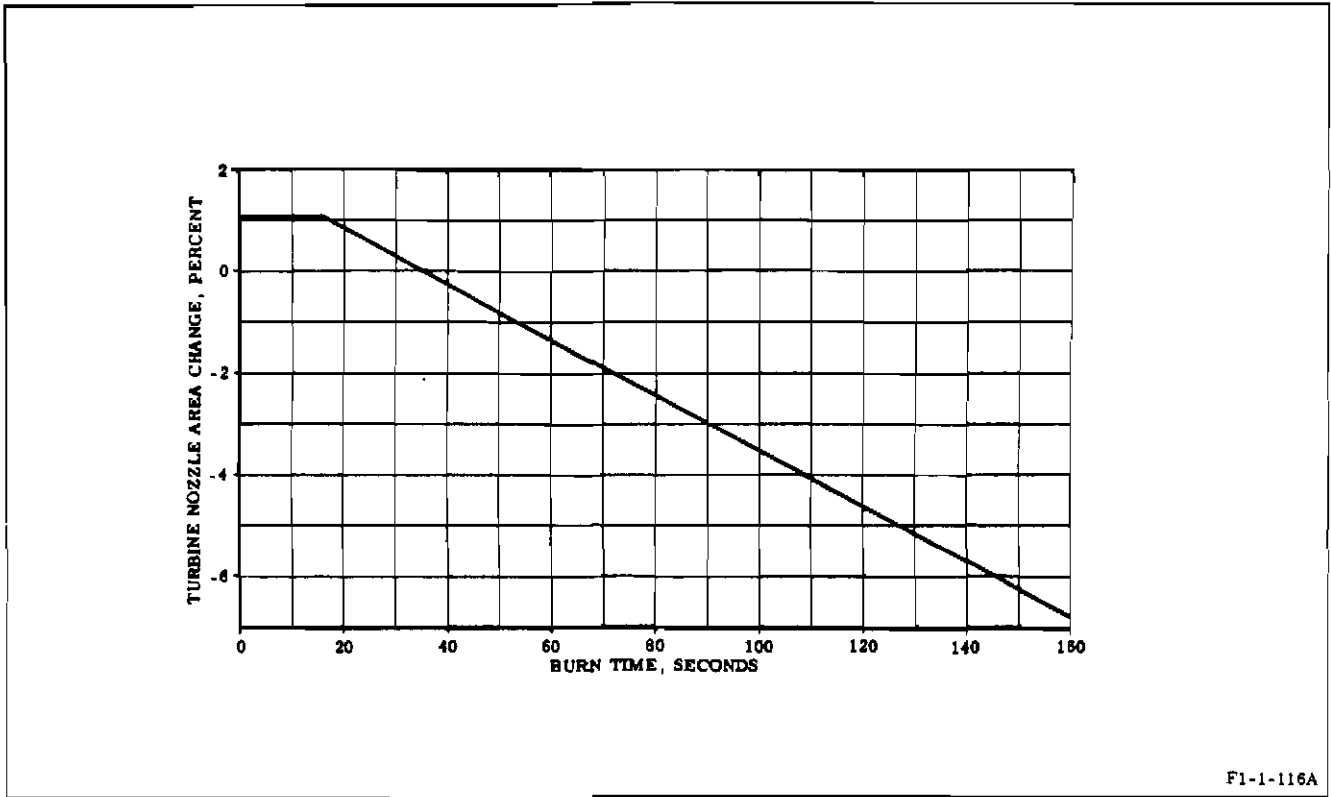

F1-1-116A

Figure 3-41A. Turbine Nozzle Area Change Versus Burn Time (Engines F-2029 Through F-2065)

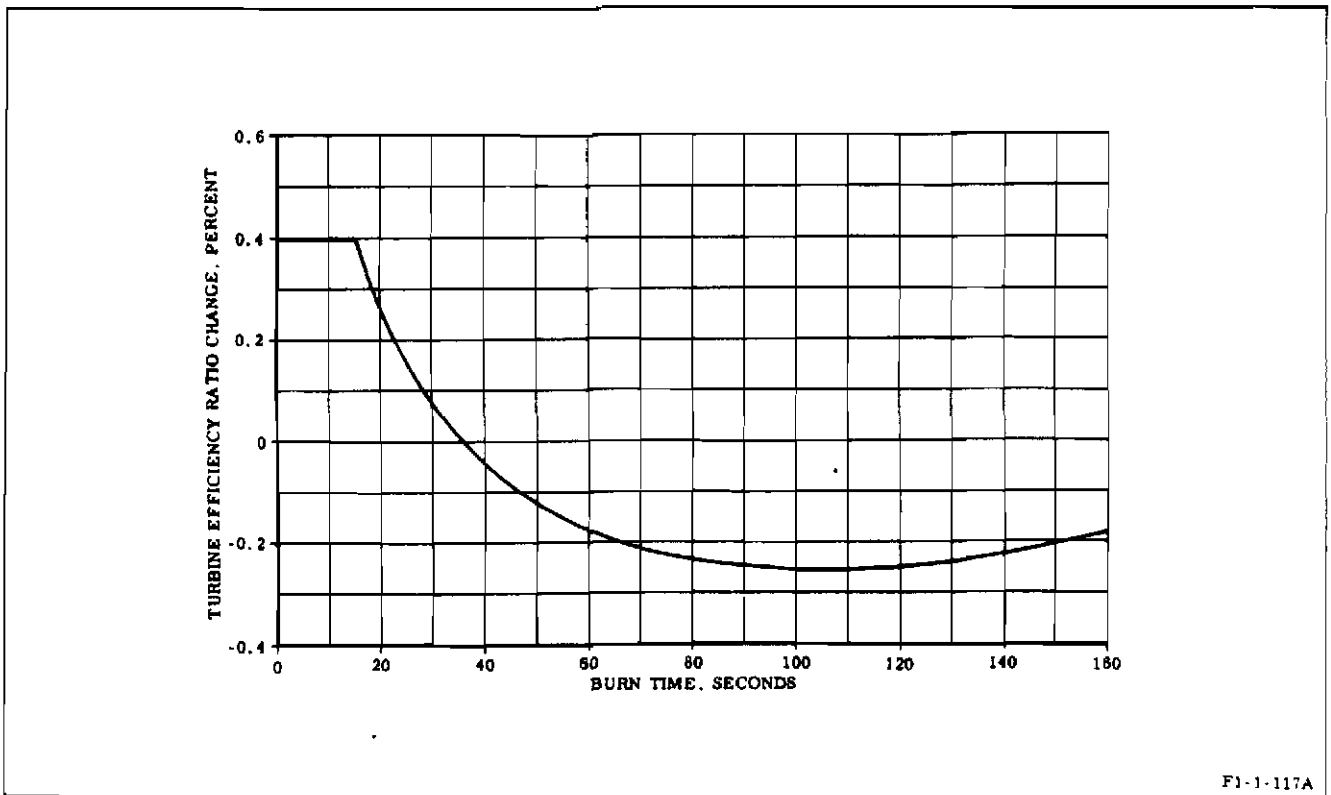

F1-1-117A

Figure 3-41B. Turbine Efficiency Ratio Curve Change Versus Burn Time (Engines F-2029 Through F-2065)

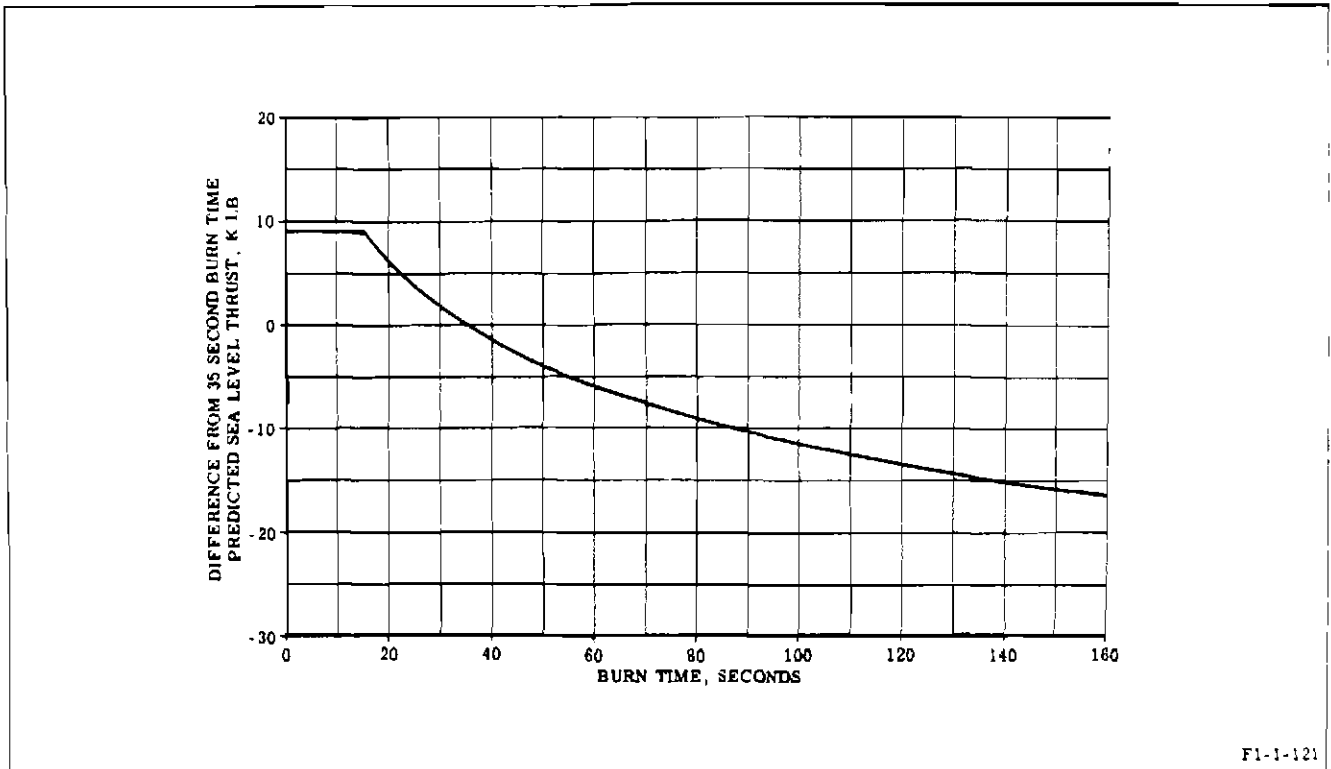

F1-1-121

Figure 3-41C. Thrust Trend for Flight (Engines F-2029 Through F-2065)

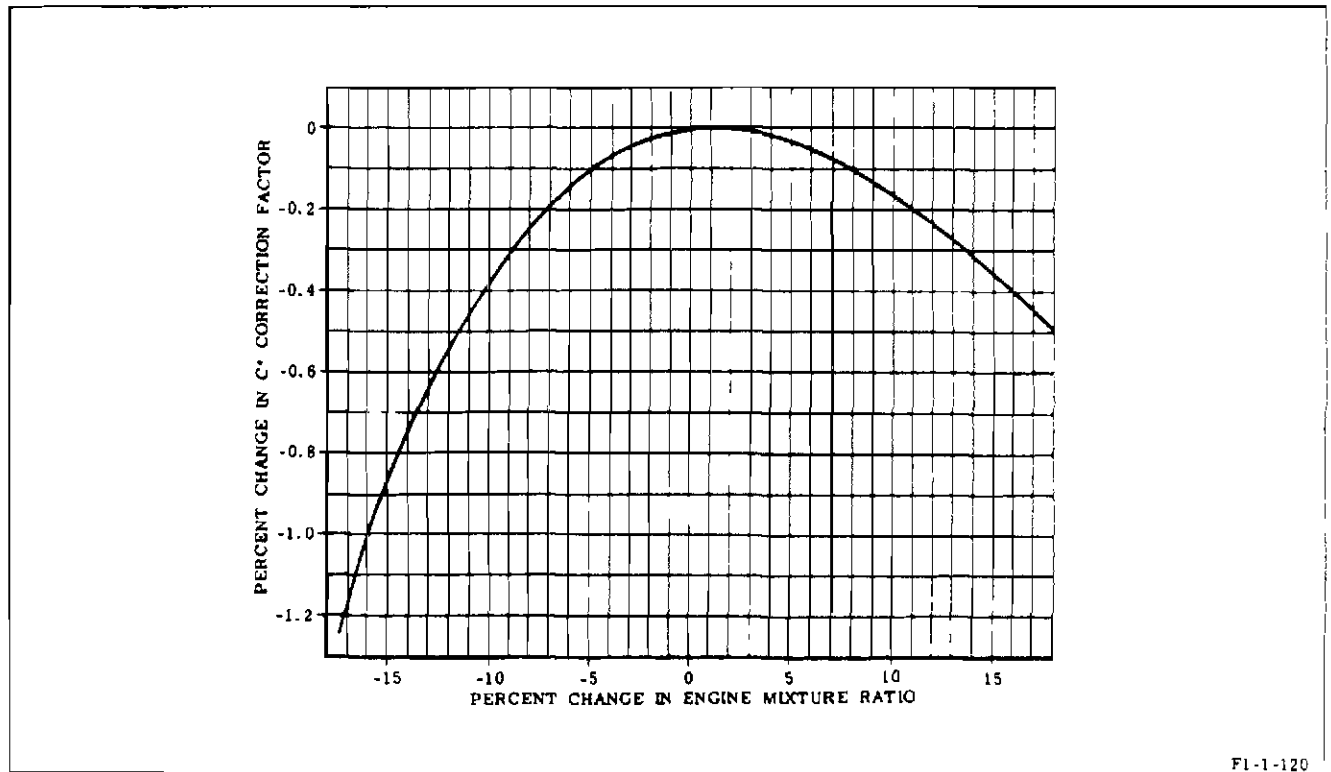

F1-1-120

Figure 3-42. C* Correction Curve (Actual) (Engines F-2029 Through F-2065)

A ONE PERCENT INCREASE IN ANY ONE OF THE INDEPENDENT VARIABLES CAUSES THE FOLLOWING PERCENTAGE CHANGE IN ANY ONE OF THE DEPENDENT VARIABLES.

| -INDEPENDENT VARIABLES- | | | | | | | | | | | | |
|--|--------------|---------|---------|---------|---------|---------|---------|---------|---------|---------|---------|--------|
| 1- | 2- | 3- | 4- | 5- | 6- | 7- | 8- | 9- | 10- | 11- | 12- | |
| 1- ATMOSPHERIC PRES | 0.14700E 02 | | | | | | | | | | | |
| 2- FUEL DENSITY (CONSTANT TEMP) | 0.10000E 01 | | | | | | | | | | | |
| 3- FUEL TEMP (CONSTANT DENSITY) | 0.60000E 02 | | | | | | | | | | | |
| 4- OXIDIZER DENSITY | 0.10000E 01 | | | | | | | | | | | |
| 5- FUEL PUMP INLET PRES | 0.45000E 02 | | | | | | | | | | | |
| 6- OXIDE PUMP INLET PRES | 0.65000E 02 | | | | | | | | | | | |
| 7- C* CORRECTION | 0.10000E 01 | | | | | | | | | | | |
| 8- ACCELERATION | 0.10000E 01 | | | | | | | | | | | |
| 9- MAIN FUEL ORIFICE RESISTANCE | 0.31342E -02 | | | | | | | | | | | |
| 10- GG OXIDIZER ORIFICE RESISTANCE | 0.77156E 01 | | | | | | | | | | | |
| 11- TURBINE INLET NOZZLE AREA | 0.17023E 02 | | | | | | | | | | | |
| 12- TURBINE EFFICIENCY MULTIPLIER | 0.10000E 01 | | | | | | | | | | | |
| -DEPENDENT VARIABLES- | | | | | | | | | | | | |
| ENGINE THRUST | 0.15220E 07 | | | | | | | | | | | |
| | -0.1464 | -0.9062 | 0.0184 | 2.0994 | -0.0083 | 0.0545 | 1.1781 | 0.0013 | -0.0264 | 0.2549 | 0.1254 | 1.2273 |
| ENGINE SPECIFIC IMPULSE | 0.26534E 03 | | | | | | | | | | | |
| | -0.1484 | -0.1391 | 0.0027 | 0.3076 | -0.0013 | 0.0080 | 1.1544 | 0.0002 | -0.0053 | -0.0368 | 0.0083 | 0.1749 |
| ENGINE MIXTURE RATIO | 0.22698E 01 | | | | | | | | | | | |
| | -0.0000 | -1.5206 | -0.0064 | 1.5094 | -0.0201 | 0.0337 | -0.0571 | 0.0007 | 0.0690 | -0.0085 | -0.0076 | 0.0232 |
| ENGINE FUEL FLOW | 0.17543E 04 | | | | | | | | | | | |
| | 0.0 | 0.2885 | 0.0201 | 0.7440 | 0.0069 | 0.0232 | 0.0633 | 0.0007 | 0.0689 | -0.2121 | 0.1224 | 1.0362 |
| ENGINE OXIDIZER FLOW | 0.39818E 04 | | | | | | | | | | | |
| | -0.0000 | -1.2321 | 0.0137 | 2.2534 | -0.0131 | 0.0569 | 0.0062 | 0.0013 | 0.0001 | -0.2206 | 0.1148 | 1.0595 |
| TC INJECTOR END PRES | 0.11248E 04 | | | | | | | | | | | |
| | 0.0 | -0.6926 | 0.0164 | 1.7325 | -0.0059 | 0.0454 | 1.0285 | 0.0011 | -0.0278 | -0.2219 | 0.1088 | 1.0675 |
| TC C* ACTUAL | 0.54514E 04 | | | | | | | | | | | |
| | 0.0000 | 0.0989 | 0.0087 | -0.0840 | 0.0014 | -0.0018 | 1.0167 | -0.0000 | -0.0058 | -0.0029 | 0.0010 | 0.0130 |
| GIMBAL SUPPLY PRESSURE | 0.18383E 04 | | | | | | | | | | | |
| | -0.0000 | -0.5947 | 0.0259 | 1.6450 | 0.0017 | 0.0459 | 0.6604 | 0.0012 | 0.0149 | -0.3047 | 0.1466 | 1.4607 |
| GG FUEL FLOW | 0.11795E 03 | | | | | | | | | | | |
| | -0.0000 | 0.4077 | 0.0159 | 0.6122 | 0.0073 | 0.0207 | 0.3862 | 0.0007 | 0.0215 | -0.1348 | 0.3911 | 0.9808 |
| GG OXIDE FLOW | 0.49045E 02 | | | | | | | | | | | |
| | 0.0000 | -0.8182 | 0.0080 | 1.8232 | -0.0079 | 0.0455 | 0.5027 | 0.0013 | -0.0124 | -0.3093 | 0.5187 | 0.9709 |
| TURBINE SPEED | 0.54922E 04 | | | | | | | | | | | |
| | -0.0000 | -0.7865 | 0.0111 | 0.8233 | -0.0080 | 0.0234 | 0.2837 | 0.0007 | -0.0076 | -0.1672 | 0.0841 | 0.8051 |
| TURBINE EXIT STATIC PRES | 0.58273E 02 | | | | | | | | | | | |
| | 0.0000 | -0.6503 | 0.0209 | 1.6968 | -0.0059 | 0.0429 | 0.4931 | 0.0012 | -0.0081 | -0.2904 | 0.5112 | 0.8618 |
| EXHAUST NOZZLE TOTAL PRES | 0.46852E 02 | | | | | | | | | | | |
| | 0.0 | -0.4888 | 0.0191 | 1.5281 | -0.0039 | 0.0393 | 0.4739 | 0.0012 | -0.0037 | -0.2657 | 0.4995 | 0.8543 |
| TURBINE MAINFOLD TEMPERATURE | 0.15560E 04 | | | | | | | | | | | |
| | 0.0 | -2.8035 | 0.0323 | 2.9285 | -0.0345 | 0.0612 | 0.3329 | 0.0015 | -0.0780 | -0.4290 | 0.2032 | 0.1301 |

Figure 3 43. Engine Influence Coefficients (Predicted) (Engines F 2088 and Subsequent)

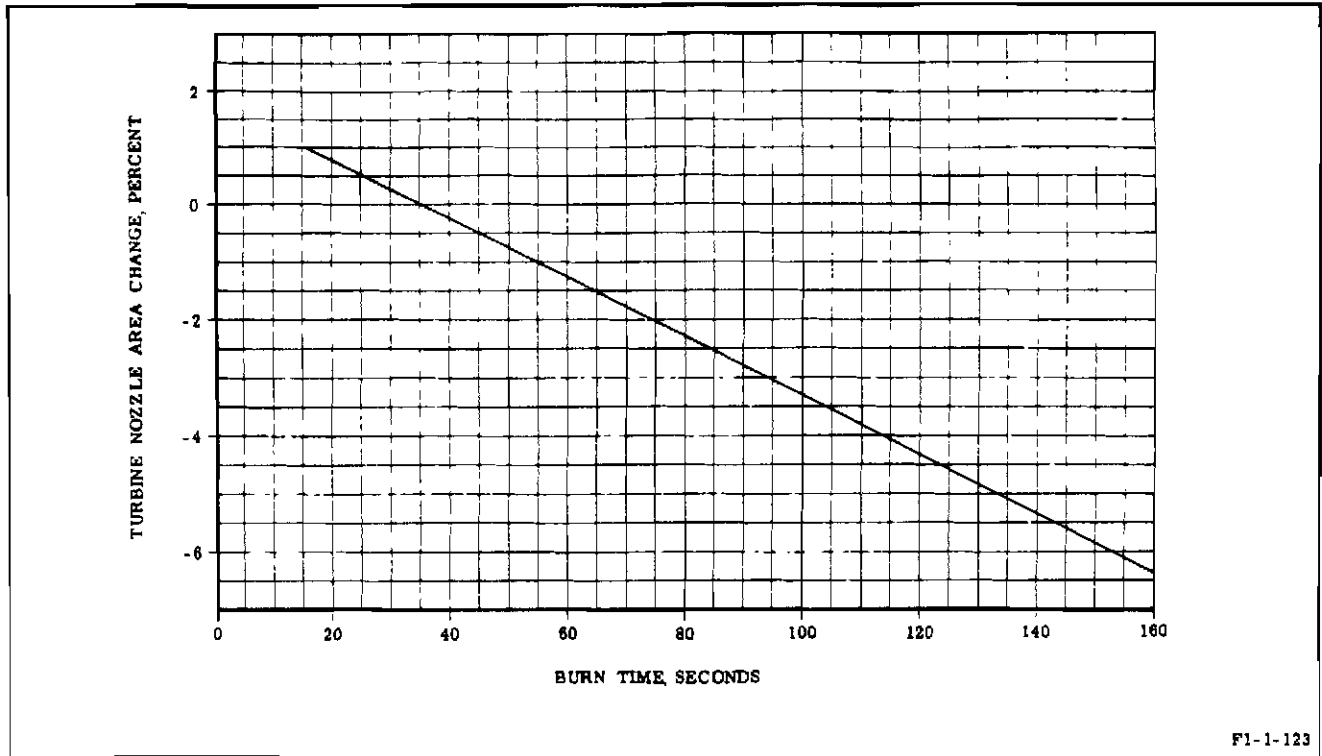

F1-1-123

Figure 3-44. Turbine Nozzle Area Change Versus Burn Time (Engines F-2066 and Subsequent)

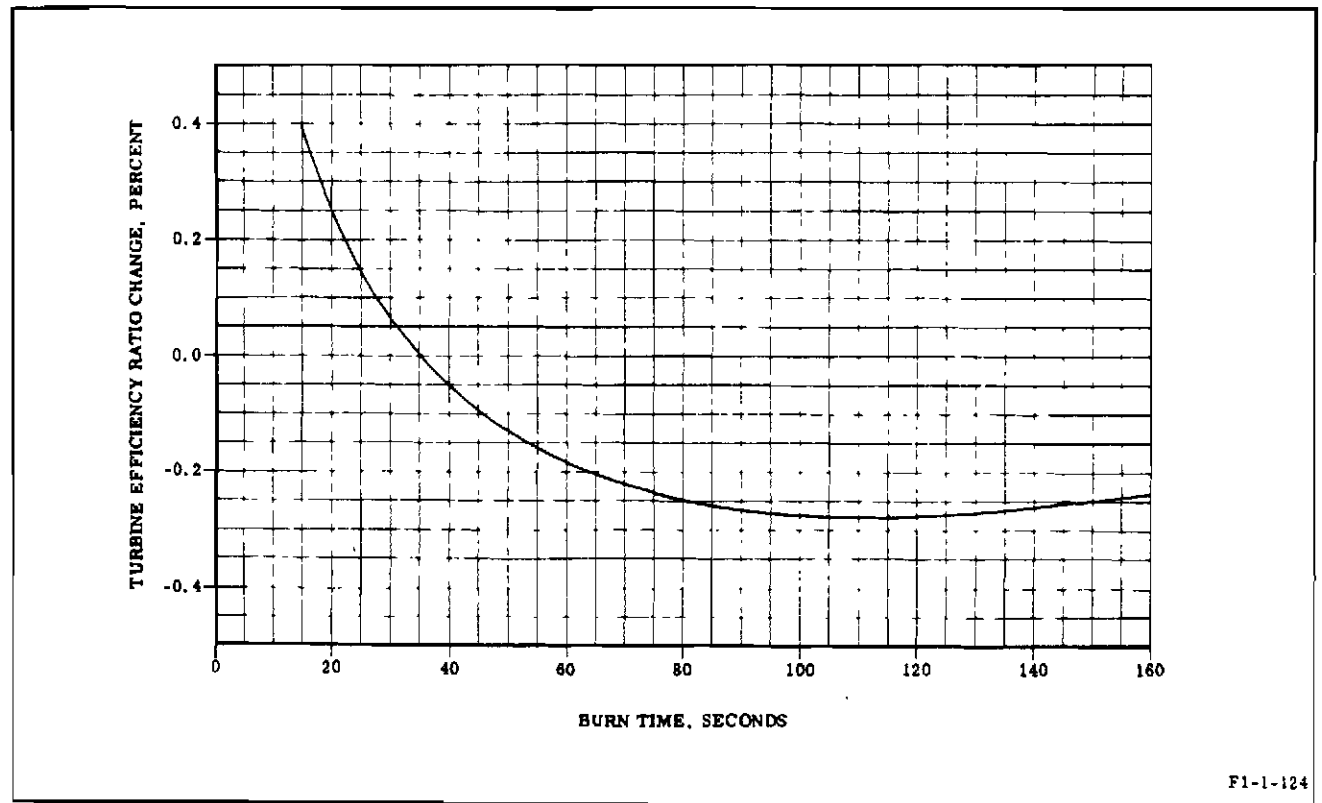

F1-1-124

Figure 3-44A. Turbine Efficiency Ratio Curve Change Versus Burn Time (Engines F-2066 and Subsequent)

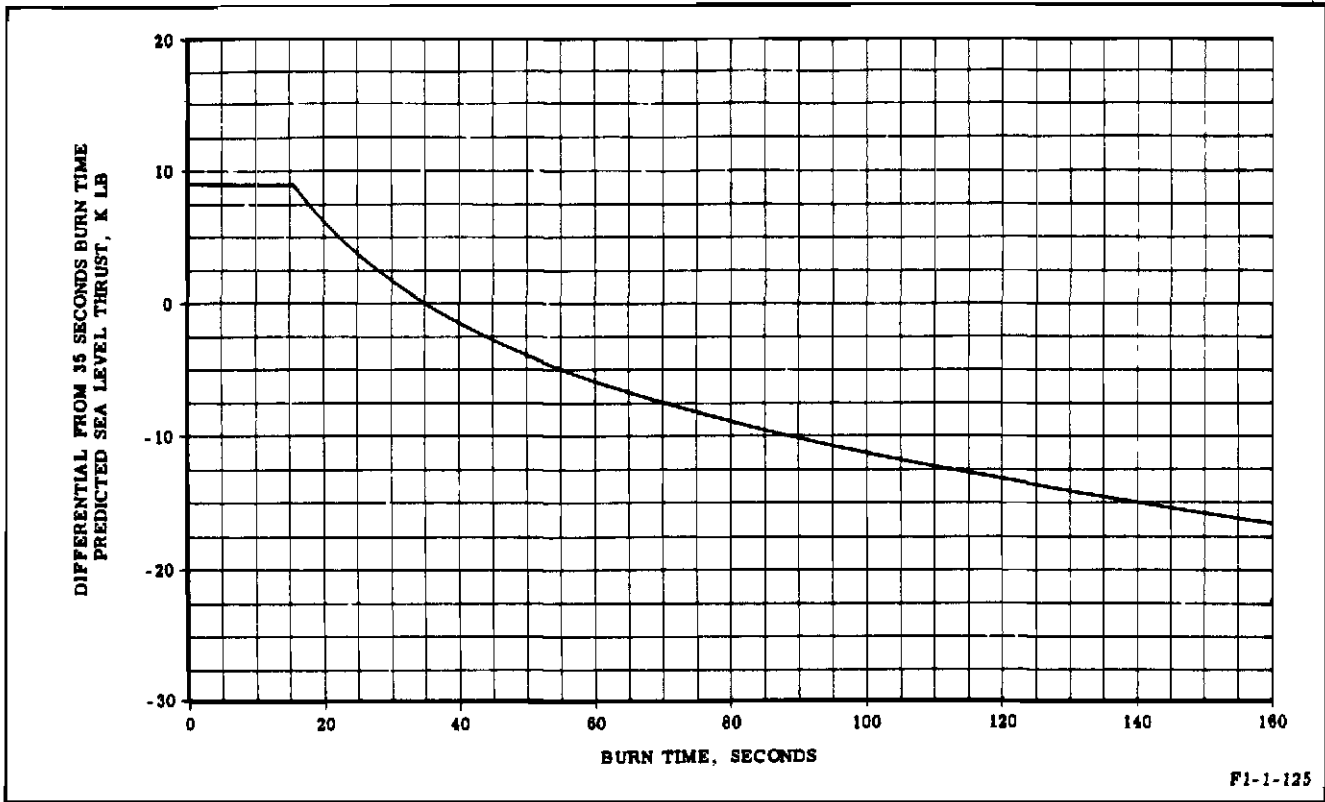

Figure 3-44B. Thrust Trend for Flight Engines (Engines F-2066 and Subsequent)

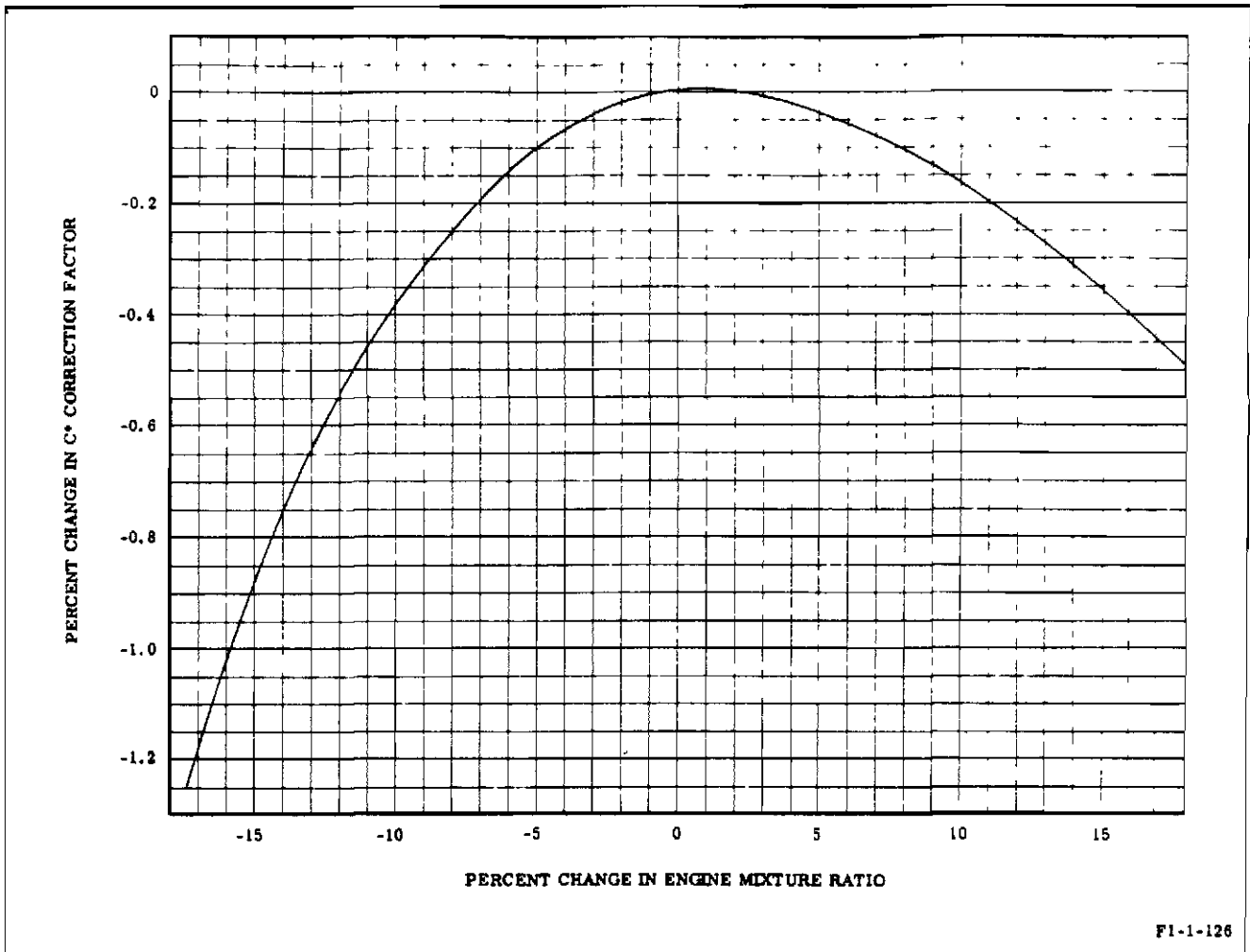

Figure 3-44C. C* Correction Curve (Actual) (Engines F-2066 and Subsequent)

ENGINE XXXX COMPONENT REPLACEMENT LOG

| Component Replacement | Thrust Deviation | Mixture Ratio Deviation | Specific Impulse Deviation |
|--|--|--|---|
| No. 1 Fuel Valve | 0.9 | 0.017 | 0.14 |
| No. 1 Turbopump Fuel Outlet Line | 0.3 | 0.007 | 0.05 |
| Expected Maximum Deviation as of (Date 1)(d) | $\left\{ \begin{array}{l} \sqrt{(0.9)^2 + (0.3)^2} \\ = 0.9 \end{array} \right.$ | $\left\{ \begin{array}{l} \sqrt{(0.017)^2 + (0.007)^2} \\ = 0.018 \end{array} \right.$ | $\left\{ \begin{array}{l} \sqrt{(0.14)^2 + (0.05)^2} \\ = 0.15 \end{array} \right.$ |
| No. 1 Turbopump Oxidizer Outlet Line | 7.1 | 0.010 | 0.14 |
| Expected Maximum Deviation as of (Date 2)(e) | $\left\{ \begin{array}{l} \sqrt{(0.9)^2 + (0.3)^2 + (7.1)^2} \\ = 7.2 \end{array} \right.$ | $\left\{ \begin{array}{l} \sqrt{(0.017)^2 + (0.007)^2 + (0.010)^2} \\ = 0.021 \end{array} \right.$ | $\left\{ \begin{array}{l} \sqrt{(0.14)^2 + (0.05)^2 + (0.14)^2} \\ = 0.20 \end{array} \right.$ |
| No. 1 Turbopump Fuel Outlet Line | 0.3 | 0.007 | 0.05 |
| Thrust Chamber Injector | 6.5 | 0.029 | 0.33 |
| Expected Maximum Deviation as of (Date 3)(f) | $\left\{ \begin{array}{l} \sqrt{(0.9)^2 + (0.3)^2 + (7.1)^2 + (6.5)^2} \\ = 9.7 \end{array} \right.$ | $\left\{ \begin{array}{l} \sqrt{(0.017)^2 + (0.007)^2 + (0.010)^2 + (0.029)^2} \\ = 0.036 \end{array} \right.$ | $\left\{ \begin{array}{l} \sqrt{(0.14)^2 + (0.05)^2 + (0.14)^2 + (0.33)^2} \\ = 0.39 \end{array} \right.$ |

(d) First component replacement since delivery (Date 1).

(e) Additional component replaced on (Date 2).

(f) Turbopump fuel outlet line No. 1 replaced second time, also main injector changed on (Date 3).

Figure 3-45. Example of Calculations Required to Determine Deviations in Engine Performance Due to Component Replacement

All data on pages 3-47 through 3-54 deleted.

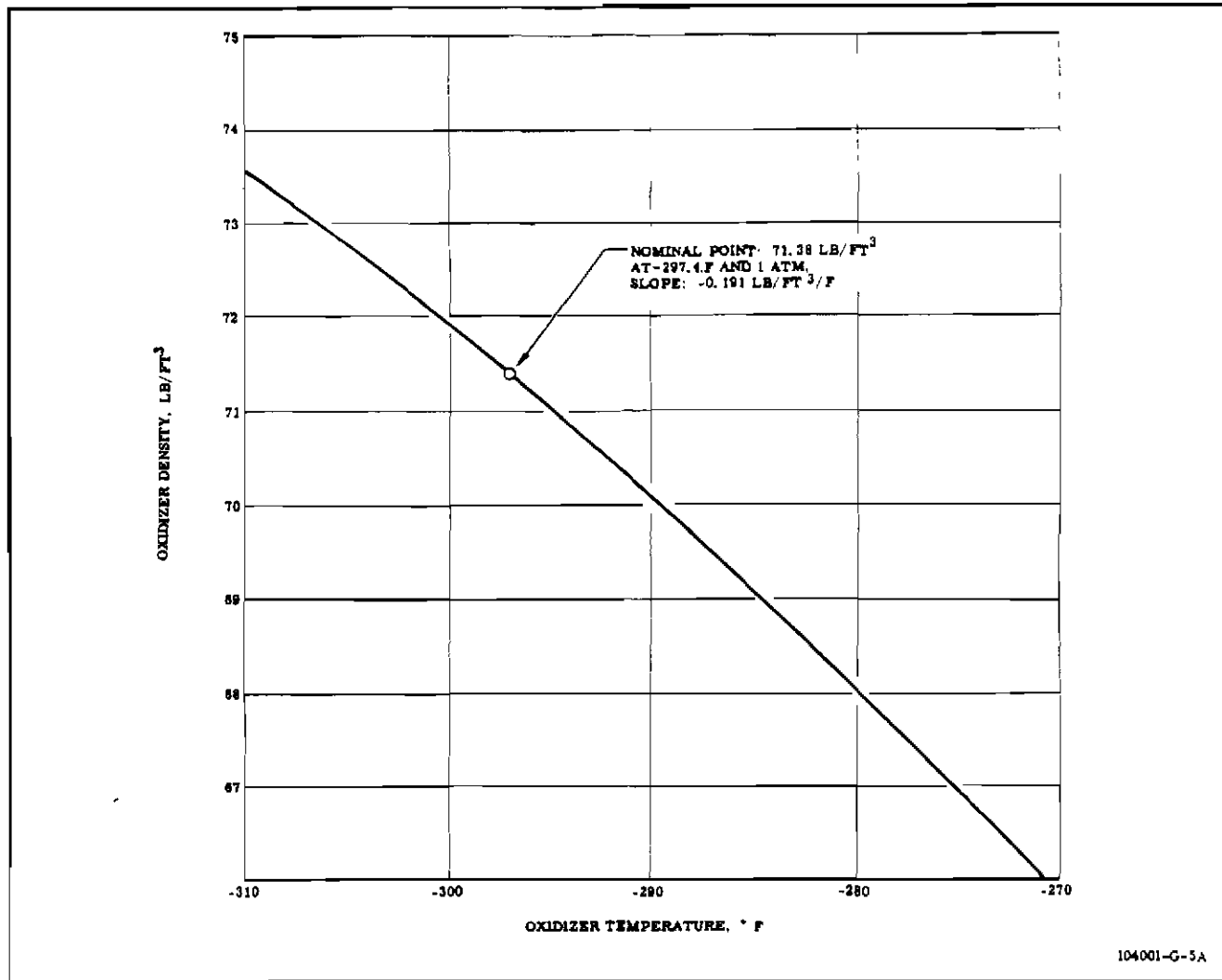

Figure 3-44. Oxidizer Density Versus Temperature

| Component Being Replaced (Engines F-2003 Through F-2010) | Sea-Level Engine Thrust Deviation (kilo-lb) | Sea-Level Engine Mixture Ratio Deviation | Sea-Level Engine Specific Impulse Deviation (sec) |
|---|---|--|--|
| Thrust Chamber Assembly | 21.5 | 0.054 | 0.83 |
| Thrust Chamber | 11.5 | 0.043 | 0.62 |
| Main Injector(a)(c) | 6.5 | 0.029 | 0.33 |
| Oxidizer Dome | 17.0 | 0.016 | 0.44 |

(a) Replacement of main injector can cause thrust vector to shift a maximum of 0.16 inch in lateral displacement and 3.6 minutes in angular displacement from present position.

(c) Replacement of main injector and/or nozzle extension cannot cause thrust vector lateral displacement to exceed 0.42 inch from engine centerline or angular displacement to exceed 21.0 minutes from engine centerline.

Figure 3-45. Deviations in Engine Performance Due to Component Replacement (Sheet 1 of 8)

| Component Being Replaced (Engines F-2003 Through F-2010) | Sea-Level Engine Thrust Deviation (kilo-lb) | Sea-Level Engine Mixture Ratio Deviation | Sea-Level Engine Specific Impulse Deviation (sec) |
|---|---|--|--|
| Turbine Exhaust System Duct With Heat Exchanger | 19.8 | 0.002 | 0.48 |
| Nozzle Extension ^{(b)(c)} | 15.0 | 0.0 | 0.60 |
| No. 1 Main LOX Orifice | 0.1 | 0.0 | 0.0 |
| No. 2 Main LOX Orifice | 0.1 | 0.0 | 0.0 |
| No. 1 Main Fuel Orifice | 0.0 | 0.0 | 0.0 |
| No. 2 Main Fuel Orifice | 0.1 | 0.0 | 0.01 |
| No. 1 Main Oxidizer Valve | 7.1 | 0.010 | 0.14 |
| No. 2 Main Oxidizer Valve | 14.3 | 0.009 | 0.40 |
| No. 1 Main Fuel Valve | 0.9 | 0.017 | 0.14 |
| No. 2 Main Fuel Valve | 7.4 | 0.014 | 0.31 |
| No. 1 Turbopump Oxidizer Outlet Line | 7.1 | 0.010 | 0.14 |
| No. 2 Turbopump Oxidizer Outlet Line | 13.0 | 0.008 | 0.36 |
| No. 1 Turbopump Fuel Outlet Line | 0.3 | 0.007 | 0.05 |
| No. 2 Turbopump Fuel Outlet Line | 1.5 | 0.003 | 0.06 |
| Turbopump | 55.0 | 0.071 | 1.13 |
| Oxidizer Pump | 30.2 | 0.055 | 0.62 |
| Inlet Assembly | 7.3 | 0.014 | 0.15 |
| Inducer | 7.3 | 0.014 | 0.15 |
| Volute | 15.8 | 0.028 | 0.33 |
| Impeller | 24.6 | 0.043 | 0.50 |
| Fuel Pump | 26.9 | 0.044 | 0.59 |
| No. 1 Inlet Elbow | 9.0 | 0.014 | 0.19 |
| No. 2 Inlet Elbow | 9.0 | 0.014 | 0.19 |
| Inlet Assembly | 9.0 | 0.014 | 0.19 |
| Inducer | 9.0 | 0.014 | 0.19 |
| Volute | 18.9 | 0.029 | 0.39 |
| Impeller | 12.0 | 0.019 | 0.25 |
| Turbine Assembly | 35.6 | 0.005 | 0.74 |
| Nozzle (Manifold) | 19.1 | 0.001 | 0.13 |
| First-Stage Wheel | 17.6 | 0.002 | 0.43 |
| Per Blade | 0.2 | 0.0 | 0.0 |
| Second-Stage Wheel | 8.8 | 0.001 | 0.22 |
| Per Blade | 0.1 | 0.0 | 0.0 |

(b) Replacement of the nozzle extension can cause thrust vector to shift a maximum of 0.31 inch in lateral displacement and 2.8 minutes in angular displacement from present position.

(c) Replacement of main injector and/or nozzle extension cannot cause thrust vector lateral displacement to exceed 0.42 inch from engine centerline or angular displacement to exceed 21.0 minutes from engine centerline.

Figure 3-45. Deviations in Engine Performance Due to Component Replacement (Sheet 2 of 8)

| Component Being Replaced (Engines F-2003 Through F-2010) | Sea-Level Engine Thrust Deviation (kilo-lb) | Sea-Level Engine Mixture Ratio Deviation | Sea-Level Engine Specific Impulse Deviation (sec) |
|---|---|--|--|
| Stator | 17.6 | 0.002 | 0.43 |
| Per Segment | 1.8 | 0.0 | 0.04 |
| Honeycomb Seal | 17.6 | 0.002 | 0.43 |
| Gas Generator Oxidizer Bootstrap Line Scoop | 6.0 | 0.001 | 0.15 |
| Gas Generator Oxidizer Bootstrap Line (Upstream) | 12.0 | 0.002 | 0.30 |
| Gas Generator Oxidizer Fixed Upstream Orifice | 0.15 | 0.0 | 0.0 |
| Gas Generator Oxidizer Bootstrap Line (Downstream) | 12.0 | 0.002 | 0.30 |
| Gas Generator Oxidizer Variable Downstream Orifice | 3.4 | 0.001 | 0.09 |
| Gas Generator Fuel Bootstrap Line | 7.8 | 0.001 | 0.25 |
| Gas Generator Fuel Orifice | 0.6 | 0.0 | 0.02 |
| Gas Generator Ball Valve | 21.2 | 0.004 | 0.61 |
| Gas Generator Injector | 31.6 | 0.005 | 0.89 |
| Gas Generator Combustor Body | 11.7 | 0.001 | 0.25 |
| (Engines F-2011 Through F-2016) | | | |
| Thrust Chamber Assembly | 21.5 | 0.054 | 0.83 |
| Thrust Chamber | 11.5 | 0.043 | 0.62 |
| Main Injector(a)(c) | 6.5 | 0.029 | 0.33 |
| Oxidizer Dome | 17.0 | 0.016 | 0.44 |
| Turbine Exhaust System Duct With Heat Exchanger | 27.0 | 0.003 | 0.66 |
| Nozzle Extension(b)(c) | 15.0 | 0.0 | 0.60 |
| No. 1 Main LOX Orifice | 0.1 | 0.0 | 0.0 |
| No. 2 Main LOX Orifice | 0.1 | 0.0 | 0.01 |
| No. 1 Main Fuel Orifice | 0.0 | 0.0 | 0.0 |
| No. 2 Main Fuel Orifice | 0.1 | 0.0 | 0.01 |
| No. 1 Main Oxidizer Valve | 7.1 | 0.010 | 0.14 |
| No. 2 Main Oxidizer Valve | 14.3 | 0.009 | 0.40 |
| No. 1 Main Fuel Valve | 0.9 | 0.017 | 0.14 |
| No. 2 Main Fuel Valve | 7.4 | 0.014 | 0.31 |
| No. 1 Turbopump Oxidizer Outlet Line | 7.1 | 0.010 | 0.14 |
| No. 2 Turbopump Oxidizer Outlet Line | 13.0 | 0.008 | 0.36 |
| No. 1 Turbopump Fuel Outlet Line | 0.3 | 0.007 | 0.05 |
| No. 2 Turbopump Fuel Outlet Line | 1.5 | 0.003 | 0.06 |

- (a) Replacement of main injector can cause thrust vector to shift a maximum of 0.16 inch in lateral displacement and 3.6 minutes in angular displacement from present position.
- (b) Replacement of the nozzle extension can cause thrust vector to shift a maximum of 0.31 inch in lateral displacement and 2.8 minutes in angular displacement from present position.
- (c) Replacement of main injector and/or nozzle extension cannot cause thrust vector lateral displacement to exceed 0.42 inch from engine centerline or angular displacement to exceed 21.0 minutes from engine centerline.

Figure 3-45. Deviations in Engine Performance Due to Component Replacement (Sheet 3 of 8)

Section III

Component Being Replaced

(Engines F-2011 Through F-201

Turbopump
Oxidizer Pump
Inlet Assembly
Inducer
Volute
Impeller

Fuel Pump
No. 1 Inlet Elbow
No. 2 Inlet Elbow
Inlet Assembly
Inducer
Volute
Impeller

Turbine Assembly
Nozzle (Manifold)
First-Stage Wheel
Per Blade

Second-Stage Wheel
Per Blade

Stator
Per Segment
Honeycomb Seal

Gas Generator Oxidizer Bootstrap Line Scoop
Gas Generator Oxidizer Bootstrap Line (Upstream)
Gas Generator Oxidizer Fixed Upstream Orifice
Gas Generator Oxidizer Bootstrap Line (Downstream)

Gas Generator Oxidizer Variable Downstream
Gas Generator Fuel Bootstrap Line
Gas Generator Fuel Orifice
Gas Generator Ball Valve

Gas Generator Injector
Gas Generator Combustor Body

(Engines F-2017 Through F-2025)

Thrust Chamber Assembly
Thrust Chamber
Main Injector(a)(c)
Oxidizer Dome

- (a) Replacement of main injector can cause
displacement and 3.6 minutes in angular
(c) Replacement of main injector and or nozzle
placement to exceed 0.42 inch from engine
minutes from engine centerline.

Figure 3-45. Deviations in Engine Performance

| Component Being Replaced (Engines F-2017 Through F-2028) | Sea-Level Engine Thrust Deviation (kilo-lb) | Sea-Level Engine Mixture Ratio Deviation | Sea-Level Engine Specific Impulse Deviation (sec) |
|---|---|--|--|
| Turbine Exhaust System Duct With Heat Exchanger | 27.0 | 0.003 | 0.66 |
| Nozzle Extension(b)(c) | 15.0 | 0.0 | 0.60 |
| No. 1 Main LOX Orifice | 0.1 | 0.0 | 0.0 |
| No. 2 Main LOX Orifice | 0.1 | 0.0 | 0.0 |
| No. 1 Main Fuel Orifice | 0.0 | 0.0 | 0.0 |
| No. 2 Main Fuel Orifice | 0.1 | 0.0 | 0.01 |
| No. 1 Main Oxidizer Valve | 13.0 | 0.019 | 0.25 |
| No. 2 Main Oxidizer Valve | 20.1 | 0.012 | 0.56 |
| No. 1 Main Fuel Valve | 1.1 | 0.022 | 0.18 |
| No. 2 Main Fuel Valve | 9.6 | 0.018 | 0.40 |
| No. 1 Turbopump Oxidizer Outlet Line | 1.3 | 0.002 | 0.02 |
| No. 2 Turbopump Oxidizer Outlet Line | 4.1 | 0.003 | 0.12 |
| No. 1 Turbopump Fuel Outlet Line | 0.2 | 0.003 | 0.03 |
| No. 2 Turbopump Fuel Outlet Line | 1.4 | 0.003 | 0.06 |
| Turbopump | 55.0 | 0.071 | 1.13 |
| Oxidizer Pump | 30.2 | 0.055 | 0.62 |
| Inlet Assembly | 7.3 | 0.014 | 0.15 |
| Inducer | 7.3 | 0.014 | 0.15 |
| Volute | 15.8 | 0.028 | 0.33 |
| Impeller | 24.6 | 0.043 | 0.50 |
| Fuel Pump | 26.9 | 0.044 | 0.59 |
| No. 1 Inlet Elbow | 9.0 | 0.014 | 0.19 |
| No. 2 Inlet Elbow | 9.0 | 0.014 | 0.19 |
| Inlet Assembly | 9.0 | 0.014 | 0.19 |
| Inducer | 9.0 | 0.014 | 0.19 |
| Volute | 18.9 | 0.029 | 0.39 |
| Impeller | 12.0 | 0.019 | 0.25 |
| Turbine Assembly | 35.6 | 0.005 | 0.74 |
| Nozzle (Manifold) | 19.1 | 0.001 | 0.13 |
| First-Stage Wheel | 17.6 | 0.002 | 0.43 |
| Per Blade | 0.2 | 0.0 | 0.0 |
| Second-Stage Wheel | 8.8 | 0.001 | 0.22 |
| Per Blade | 0.1 | 0.0 | 0.0 |
| Stator | 17.6 | 0.002 | 0.43 |
| Per Segment | 1.8 | 0.0 | 0.04 |
| Honeycomb Seal | 17.6 | 0.002 | 0.43 |

(b) Replacement of the nozzle extension can cause thrust vector to shift a maximum of 0.31 inch in lateral displacement and 2.8 minutes in angular displacement from present position.

(c) Replacement of main injector and/or nozzle extension cannot cause thrust vector lateral displacement to exceed 0.42 inch from engine centerline or angular displacement to exceed 21.0 minutes from engine centerline.

Figure 3-45. Deviations in Engine Performance Due to Component Replacement (Sheet 5 of 8)

| Component Being Replaced (Engines F-2017 Through F-2028) | Sea-Level Engine Thrust Deviation (kilo-lb) | Sea-Level Engine Mixture Ratio Deviation | Sea-Level Engine Specific Impulse Deviation (sec) |
|---|---|--|--|
| Gas Generator Oxidizer Bootstrap Line Scoop | 6.0 | 0.001 | 0.15 |
| Gas Generator Oxidizer Bootstrap Line (Upstream) | 12.0 | 0.002 | 0.30 |
| Gas Generator Oxidizer Fixed Upstream Orifice | 1.9 | 0.0 | 0.04 |
| Gas Generator Oxidizer Bootstrap Line (Downstream) | 12.0 | 0.002 | 0.30 |
| Gas Generator Oxidizer Variable Downstream Orifice | 1.9 | 0.0 | 0.05 |
| Gas Generator Fuel Bootstrap Line | 7.8 | 0.001 | 0.25 |
| Gas Generator Fuel Orifice | 1.1 | 0.0 | 0.04 |
| Gas Generator Ball Valve | 21.2 | 0.004 | 0.61 |
| Gas Generator Injector | 31.6 | 0.005 | 0.89 |
| Gas Generator Combustor Body | 11.7 | 0.001 | 0.25 |
| (Engines F-2029 and Subsequent) | | | |
| Fuel Pump | 26.9 | 0.044 | 0.59 |
| No. 1 Inlet Elbow | 9.0 | 0.014 | 0.19 |
| No. 2 Inlet Elbow | 9.0 | 0.014 | 0.19 |
| Inlet Assembly | 9.0 | 0.014 | 0.19 |
| Inducer | 9.0 | 0.014 | 0.19 |
| Volute | 18.9 | 0.029 | 0.39 |
| Impeller | 12.0 | 0.019 | 0.25 |
| Turbine Assembly | 35.6 | 0.005 | 0.74 |
| Nozzle (Manifold) | 19.1 | 0.001 | 0.13 |
| First-Stage Wheel | 17.6 | 0.002 | 0.43 |
| Per Blade | 0.2 | 0.0 | 0.0 |
| Second-Stage Wheel | 8.8 | 0.001 | 0.22 |
| Per Blade | 0.1 | 0.0 | 0.0 |
| Stator | 17.6 | 0.002 | 0.43 |
| Per Segment | 1.8 | 0.0 | 0.04 |
| Honeycomb Seal | 17.6 | 0.002 | 0.43 |
| Gas Generator Oxidizer Bootstrap Line Scoop | 6.0 | 0.001 | 0.15 |
| Gas Generator Oxidizer Bootstrap Line (Upstream) | 12.0 | 0.002 | 0.30 |
| Gas Generator Oxidizer Fixed Upstream Orifice | 1.9 | 0.0 | 0.04 |
| Gas Generator Oxidizer Bootstrap Line (Downstream) | 12.0 | 0.002 | 0.30 |
| Gas Generator Oxidizer Variable Downstream Orifice | 1.9 | 0.0 | 0.05 |
| Gas Generator Fuel Bootstrap Line | 7.8 | 0.001 | 0.25 |
| Gas Generator Fuel Orifice | 1.1 | 0.0 | 0.04 |
| Gas Generator Ball Valve | 21.2 | 0.004 | 0.61 |
| Gas Generator Injector | 31.6 | 0.005 | 0.89 |
| Gas Generator Combustor Body | 11.7 | 0.001 | 0.25 |

Figure 3-45. Deviations in Engine Performance Due to Component Replacement (Sheet 6 of 8)

| Component Being Replaced (Engines F-2029 and Subsequent) | Sea-Level Engine Thrust Deviation (kilo-lb) | Sea-Level Engine Mixture Ratio Deviation | Sea-Level Engine Specific Impulse Deviation (sec) |
|---|---|--|--|
| Thrust Chamber | 21.5 | 0.054 | 0.83 |
| Thrust Chamber | 11.5 | 0.043 | 0.62 |
| Main Injector (a)(c) | 6.5 | 0.029 | 0.33 |
| Oxidizer Dome | 17.0 | 0.016 | 0.44 |
| Turbine Exhaust System Duct With Heat Exchanger | 27.0 | 0.003 | 0.66 |
| Nozzle Extension(b)(c) | 15.0 | 0.0 | 0.60 |
| No. 1 Main LOX Orifice | 0.1 | 0.0 | 0.0 |
| No. 2 Main LOX Orifice | 0.1 | 0.0 | 0.0 |
| No. 1 Main Fuel Orifice | 0.0 | 0.0 | 0.0 |
| No. 2 Main Fuel Orifice | 0.1 | 0.0 | 0.01 |
| No. 1 Main Oxidizer Valve | 13.0 | 0.019 | 0.25 |
| No. 2 Main Oxidizer Valve | 20.1 | 0.012 | 0.56 |
| No. 1 Main Fuel Valve | 1.1 | 0.022 | 0.18 |
| No. 2 Main Fuel Valve | 9.6 | 0.018 | 0.40 |
| No. 1 Turbopump Oxidizer Outlet Line | 1.3 | 0.002 | 0.02 |
| No. 2 Turbopump Oxidizer Outlet Line | 4.1 | 0.003 | 0.12 |
| No. 1 Turbopump Fuel Outlet Line | 0.2 | 0.003 | 0.03 |
| No. 2 Turbopump Fuel Outlet Line | 1.4 | 0.003 | 0.06 |
| Turbopump | 55.0 | 0.071 | 1.13 |
| Oxidizer Pump | 30.2 | 0.055 | 0.62 |
| Inlet Assembly | 7.3 | 0.014 | 0.15 |
| Inducer | 7.3 | 0.014 | 0.15 |
| Volute | 15.8 | 0.028 | 0.33 |
| Impeller | 24.6 | 0.043 | 0.50 |

- (a) Replacement of main injector can cause thrust vector to shift a maximum of 0.16 inch in lateral displacement and 3.6 minutes in angular displacement from present position.
- (b) Replacement of the nozzle extension can cause thrust vector to shift a maximum of 0.31 inch in lateral displacement and 2.8 minutes in angular displacement from present position.
- (c) Replacement of main injector and/or nozzle extension cannot cause thrust vector lateral displacement to exceed 0.42 inch from engine centerline or angular displacement to exceed 21.0 minutes from engine centerline.

Figure 3-45. Deviations in Engine Performance Due to Component Replacement (Sheet 7 of 8)

ENGINE XXXX COMPONENT REPLACEMENT LOG

| Component Replacement | Thrust Deviation | Mixture Ratio Deviation | Specific Impulse Deviation |
|--|---|---|--|
| No. 1 Fuel Valve | 0.9 | 0.017 | 0.14 |
| No. 1 Turbopump Fuel Outlet Line | 0.3 | 0.007 | 0.05 |
| Expected Maximum Deviation as of (Date 1) ^(d) | $\sqrt{(0.9)^2+(0.3)^2}$ = 0.9 | $\sqrt{(0.017)^2+(0.007)^2}$ = 0.018 | $\sqrt{(0.14)^2+(0.05)^2}$ = 0.15 |
| No. 1 Turbopump Oxidizer Outlet Line | 7.1 | 0.010 | 0.14 |
| Expected Maximum Deviation as of (Date 2) ^(e) | $\sqrt{(0.9)^2+(0.3)^2+(7.1)^2}$ = 7.2 | $\sqrt{(0.017)^2+(0.007)^2+(0.010)^2}$ = 0.021 | $\sqrt{(0.14)^2+(0.05)^2+(0.14)^2}$ = 0.20 |
| No. 1 Turbopump Fuel Outlet Line | 0.3 | 0.007 | 0.05 |
| Thrust Chamber Injector | 6.5 | 0.029 | 0.33 |
| Expected Maximum Deviation as of (Date 3) ^(f) | $\sqrt{(0.9)^2+(0.3)^2+(7.1)^2+(6.5)^2}$ = 9.7 | $\sqrt{(0.017)^2+(0.007)^2+(0.010)^2+(0.029)^2}$ = 0.036 | $\sqrt{(0.14)^2+(0.05)^2+(0.14)^2+(0.33)^2}$ = 0.39 |

(d) First component replacement since delivery (Date 1).

(e) Additional component replaced on (Date 2).

(f) Turbopump fuel outlet line No. 1 replaced second time, also main injector changed on (Date 3).

Figure 3-45. Deviations in Engine Performance Due to Component Replacement (Sheet 8 of 8)

3-48. ENGINE TEST INSTRUMENTATION.

3-49. A list of the available engine instrumentation taps is presented in figure 3-46. Selection of instrumentation to determine engine

operation and performance during static tests shall be a customer requirement. Recommended instrument range and instrument precision is also shown in figure 3-46. Refer to section II for instrumentation tap locations.

| Parameter (Pressure) | Range (psig) | Precision (Percent) | Tap | Recording (Low) | Frequency (High) |
|---|-----------------|------------------------|----------|--------------------|---------------------|
| LOX Pump Inlet ^{(a)(b)} | 0-200 | | Facility | | X |
| LOX Pump Inlet ^(c) | 0-200 | ±0.50 | Facility | X | |
| No. 1 LOX Pump Discharge | 0-2,000 | ±0.50 | PO2b-1 | X | |
| No. 2 LOX Pump Discharge | 0-2,000 | ±0.50 | PO2b-2 | X | |
| No. 1 LOX Pump Discharge ^{(a)(b)} | 0-2,000 | | PO2d-1 | | X |
| No. 2 LOX Pump Discharge ^{(a)(b)} | 0-2,000 | | PO2c-2 | | X |
| No. 1 Main LOX Valve Inlet | 0-2,000 | ±1.00 | PO3-1 | X | |
| No. 2 Main LOX Valve Inlet | 0-2,000 | ±1.00 | PO3-2 | X | |
| GG LOX Valve Inlet | 0-2,000 | ±1.00 | GO1a | X | |
| GG LOX Valve Inlet ^(a) | 0-2,500 | | GO1b | X | |
| GG LOX Injection ^(a) | 0-1,500 | ±1.00 | GO2a | X | |
| LOX Pump Seal Cavity | 0-25 | ±1.00 | PO7b | X | |
| No. 1 LOX Dome Inlet | 0-2,000 | ±1.00 | CO1b-1 | X | |
| No. 2 LOX Dome Inlet | 0-2,000 | ±1.00 | CO1b-2 | X | |
| LOX Injection | 0-2,000 | ±1.00 | CO3c | X | |
| LOX Injection ^{(a)(b)} | 0-2,000 | | CO3h | | X |
| Heat Exchanger LOX Inlet | 0-2,000 | ±1.00 | HO1c | X | |
| Heat Exchanger GOX Outlet | 0-2,000 | ±1.00 | HO4c | X | |
| No. 1 Fuel Pump Inlet ^(c) | 0-200 | ±0.50 | KF6b-1 | X | |
| No. 1 Fuel Pump Inlet ^{(a)(b)} | 0-200 | | KF7a-1 | | X |
| No. 2 Fuel Pump Inlet ^(c) | 0-200 | ±0.50 | KF6d-2 | X | |
| No. 1 Fuel Pump Discharge | 0-2,500 | ±0.50 | PF2b-1 | X | |
| No. 1 Fuel Pump Discharge ^{(a)(b)} | 0-2,500 | | PF2d-1 | | X |
| No. 1 Fuel Pump Discharge | 0-2,500 | | PF2c-1 | X | |
| No. 2 Fuel Pump Discharge | 0-2,500 | ±0.50 | PF2b-2 | X | |
| No. 2 Fuel Pump Discharge ^{(a)(b)} | 0-2,500 | | PF2c-2 | | X |
| No. 1 Main Fuel Valve Inlet | 0-2,500 | ±1.00 | PF3a-1 | X | |
| No. 2 Main Fuel Valve Inlet | 0-2,500 | ±1.00 | PF3a-2 | X | |
| Fuel Manifold | 0-2,000 | ±1.00 | CF1c | X | |
| Fuel Manifold ^{(a)(b)} | 0-2,000 | | CF1b | | X |
| Fuel Injection | 0-2,000 | ±1.00 | CF2c | X | |
| Fuel Injection ^{(a)(b)} | 0-2,000 | | CF2a | | X |
| Fuel Impeller Backcasing | 0-1,000 | ±1.00 | PF10 | X | |
| GG Fuel Valve Inlet | 0-2,000 | ±1.00 | GF1 | X | |
| GG Fuel Injection | 0-1,500 | ±1.00 | GF2a | X | |
| LOX Pump Bearing Jet | 0-1,000 | ±1.00 | LB1b | X | |
| Control System Ground Supply | 0-2,500 | ±1.00 | NH0 | X | |
| Control System Supply | 0-2,500 | ±1.00 | NH1a | X | |
| Control System Supply | 0-2,500 | | NH1b | X | |

(a) Engine-mounted transducer.

(b) All high-frequency pressure instrumentation must have a range of dc to 10 kc ±2 db.

(c) Mount transducers on facility at pump inlet level within ±1 foot.

Figure 3-46. Engine Instrumentation Parameters (Sheet 1 of 3)

| Parameter (Pressure) | Range (psig) | Precision (Percent) | Tap | Recording (Low) | Frequency (High) |
|---|------------------|------------------------|------------------------|--------------------|---------------------|
| Engine Control Closing | 0-2,500 | ±1.00 | NH2b | X | |
| Engine Control Opening | 0-2,500 | ±1.00 | NH3b | X | |
| Common Hydraulic Return | 0-500 | ±2.00 | NH5b | X | |
| Common Hydraulic Return | 0-500 | | NH5a | X | |
| Igniter Fuel Valve Inlet | 0-2,500 | | IF2 | X | |
| Hypergol Container Inlet | 0-2,500 | | IF3 | X | |
| Combustion Chamber ^{(a)(b)} | 0-3,600 | | CG1a | | X |
| Combustion Chamber | 0-1,500 | ±0.50 | CG1b | X | |
| Combustion Chamber | 0-1,500 | | CG1d | X | |
| GG Chamber ^{(a)(b)} | 0-1,500 | | GG1c | | X |
| GG Chamber | 0-1,500 | ±0.50 | GG1b | X | |
| Turbine Inlet | 0-1,500 | ±0.50 | GG2a | X | |
| Turbine Outlet | 0-100 | ±0.50 | TG5a | X | |
| LOX Pump Seal Purge | 0-200 | ±1.00 | CCP | X | |
| GG Fuel Purge ^(d) | 0-500 | ±3.00 | CCP | X | |
| LOX Dome Purge | 0-1,500 | ±3.00 | CCP | X | |
| Heat Exchanger Helium Inlet | 0-500 | ±1.00 | HH2c | X | |
| Heat Exchanger Helium Outlet | 0-500 | ±1.00 | HH3c | X | |
| Parameter (Temperature) | Range (° F) | | | | |
| Heat Exchanger GOX Outlet | 0-1,000 | ±1.00 | HO3 | X | |
| Heat Exchanger Helium Coil Outlet | 0-500 | ±1.00 | HH4 | X | |
| Turbine Inlet ^(e) | 0-2,000 | ±1.00 | GG2b | X | |
| Turbine Inlet (Manifold) ^(e) | 0-2,000 | ±1.00 | TG4b | X | |
| Turbine Outlet ^(e) | 0-2,000 | ±1.00 | TG5b | X | |
| Heat Exchanger LOX Inlet ^(f) | -300 to -250 | ±1.00 | HO2 | X | |
| Parameter (Acceleration) | Range (g rms) | | | | |
| LOX Pump Inlet Flange ^(g) | 0-250 | | PZA1-Y ^(h) | | X |
| LOX Dome Pos. 10 ⁽ⁱ⁾ | 0-707 | | CZA10-Y ^(h) | | X |
| LOX Dome Pos. 4 ⁽ⁱ⁾ | 0-707 | | CZA4-Y ^(h) | | X |
| Elbow to Inlet Flange Fuel Pump No. 1 Side ^{(g)(j)} | 0-250 | | PZA2-Y ^(h) | | X |
| Elbow to Inlet Flange Fuel Pump No. 1 Side ^(g) | 0-250 | | PZA3-Z | | X |

(a) Engine-mounted transducer.
(b) All high-frequency pressure instrumentation must have a range of dc to 10 kc ±2 db.
(d) On engines not incorporating MD70 or MD83 change.
(e) Thermocouple R452VC-16 gage must be immersed to one-inch depth, which is defined as the linear distance from inside wall of component at point of thermocouple insertion to thermocouple junction.
(f) Heat exchanger oxidizer inlet temperature bulb must be immersed 0.75 ±0.5 inch. (Refer to footnote e.)
(g) 0-3,500 cps low-pass filter.
(h) Centerline of tapped hole is approximately parallel to y-axis.
(i) 0-10,000 cps low-pass filter.
(j) Tri-axial mounting pad.

Figure 3-46. Engine Instrumentation Parameters (Sheet 2 of 3)

| Parameter (Acceleration) | Range (g rms) | Precision (Percent) | Tap | Recording (Low) | Frequency (High) |
|---|------------------|------------------------|--|--------------------|---------------------|
| Boss of Fuel Pump Housing ^{(g)(j)} | 0-250 | | PZA8-Z ^(h) | | X |
| Boss of Fuel Pump Housing ^(g) | 0-250 | | PZA9-Z ^(k) | | X |
| LOX Dome Pos. 7 ^(g) | 0-250 | | CZA7-X ^(k) | | X |
| Gas Generator Combustor ^{(g)(l)} | 0-500 | | Y-Axis Adapter Block ^(h) | | X |
| Gas Generator Combustor ^{(g)(l)} | 0-500 | | Z-Axis Adapter Block ^(m) | | X |
| LOX Dome Pos. 1 ⁽ⁱ⁾ | 0-707 | | CZA1-Y ^(h) | | |
| LOX Dome Pos. 2 ⁽ⁱ⁾ | 0-250 | | CZA2-Y ^(h) | | X |

(g) 0-3,500 cps low-pass filter.

(h) Centerline of tapped hole is approximately parallel to y-axis.

(i) 0-10,000 cps low-pass filter.

(j) Tri-axial mounting pad.

(k) Centerline of tapped hole is approximately parallel to x-axis.

(l) Adapter 88-702887 and bolt 88-702885-3, or equivalent, must be used in conjunction with the gas generator acceleration instrumentation.

(m) Centerline of tapped hole is approximately parallel to z-axis.

Figure 3-46. Engine Instrumentation Parameters (Sheet 3 of 3)

MANUAL DATA SUPPLEMENTS

Manual Data Supplements are issued from time to time to communicate important and urgent information concerning the equipment covered in this manual. These Supplements bear an identifying number and should be filed in this Appendix.

Manual Data Supplements directly affect the data in this manual and will be incorporated into this manual during a future updating effort.

A Supplement Record is issued periodically to indicate the status of Supplements issued for

this manual. The status of each Supplement is indicated in the "Supplement Status" column. For active Supplements, no status is entered. For incorporated Supplements, "Incorporated" is entered.

Upon receipt of a Manual Data Supplement, make an appropriate reference to the Supplement in the margin next to the data supplemented. Supplements that have been incorporated into this manual shall be discarded.

MANUAL DATA SUPPLEMENT RECORD

This Supplement Record indicates the status of Supplements issued for Technical Manual R-3896-1 as of the date specified above. Supplements which have been incorporated into

the manual shall be removed from the Appendix and destroyed. This Supplement Record supersedes Supplement Record dated 14 June 1966.

| Supplement Number | Dated | Description | Supplement Status |
|-------------------|--------------|---|-------------------|
| R-3896-1-1 | 14 June 1966 | Changes methods of determining heat exchanger oxidizer and helium bypass orifice sizes. | Incorporated |
| R-3896-1-2 | 30 June 1966 | Corrects stage condition fuel and oxidizer inlet pressure requirements for predicting engine start times, and corrects equation used to predict time from engine control valve start signal to hypergol switch dropout. | Incorporated |
| R-3896-1-3 | 9 June 1971 | Changes the description of the engine envelope dimensions and the engine dry weight to be compatible with data presented in section II. | Incorporated |